

REGIONAL WATER SUPPLY PLAN

Final Report

Submitted For Endorsement
October 1996



Prepared by the Water Providers of the Portland Metropolitan Area

REGIONAL WATER SUPPLY PLAN

for the

Portland Metropolitan Area

FINAL REPORT

Submitted for Endorsement

October 1996

THIS PLAN WAS FINANCED AND MANAGED BY THE FOLLOWING PARTICIPANTS:

City of Beaverton
Canby Utility Board
Clackamas River Water
Damascus Water District
City of Fairview
City of Gladstone
City of Gresham
City of Hillsboro Utilities Commission
City of Forest Grove
City of Lake Oswego
Metro
City of Milwaukie
Mt. Scott Water District
Oak Lodge Water District
City of Portland
Raleigh Water District
Rockwood Water
City of Sandy
City of Sherwood
South Fork Water Board:
 City of Oregon City/City of West Linn
City of Tigard
City of Troutdale
City of Tualatin
Tualatin Valley Water District
West Slope Water District
City of Wilsonville
City of Wood Village

CONSULTANT TEAM:

Barakat & Chamberlin, Inc.
Montgomery Watson
Barney & Worth
Murray, Smith & Associates
Squier Associates
Parametrix, Inc.
McArthur & Associates
Pete Swartz

CONTENTS

I.	INTRODUCTION	1
	History of the Regional Water Supply Planning Effort	1
	Project Participants	4
	An Overview of Integrated Resource Planning	5
II.	THE REGIONAL WATER SUPPLY PLAN: AN OVERVIEW	8
	Potential Resource Additions	10
	The Region's Need for New Resources	12
III.	PUBLIC INFORMATION AND INVOLVEMENT IN THE REGIONAL WATER SUPPLY PLANNING PROCESS	14
	Project Scoping	14
	Regional Water Supply Plan	15
	Highlights of Public Input	19
	Incorporating Public Input into the Plan	23
IV.	REGIONAL POLICY OBJECTIVES, EVALUATION CRITERIA, AND IMPLEMENTATION ACTIONS	25
	The Process to Develop Regional Policy Objectives	25
	The Policy Objectives, Evaluation Criteria, and Implementation Actions ..	26
	Efficient Use of Water	27
	Water Supply Shortages	27
	Impacts of Catastrophic Events	33
	Water Quality	34
	Economic Costs and Cost Equity	36
	Environmental Stewardship	38
	Growth and Land Use Planning	40
	Flexibility to Deal with Future Uncertainty	41
	Ease of Implementation	42
	Operational Flexibility	42
	Conclusion	43
V.	FUTURE WATER DEMANDS IN THE REGION	44
	Introduction	44
	Key Features of the Forecasting Approach	44
	Gross Water Demand Forecast	47
	Net and Price-net Water Demand Forecasts	48
	Peak Day Demand Forecast	50

Discussion of Results	51
Future Forecast Updates	67
VI. EXISTING AND COMMITTED RESOURCES: THE BASE CASE	68
Existing Water Supply Sources and Facilities	70
Existing Local Water Supply Sources and Facilities	73
Transmission and Storage	73
Additional Committed Resources	73
VII. ANALYSIS OF WATER SUPPLY SOURCE OPTIONS	77
Components of the Source Option Analysis	77
Flavor Profile Analysis	79
Results of Source Option Analyses	82
Conclusion	134
VIII. ANALYSIS OF REGIONAL AND SUBREGIONAL TRANSMISSION OPTIONS	135
Regional Reservoirs	135
Major Transmission Corridors	136
Local Transmission	142
Cost Estimates	147
Conclusion	149
IX. ANALYSIS OF CONSERVATION OPTIONS	150
The Universe of Conservation Measures	150
Screening of Conservation Measures	150
Development of Conservation Program Concepts	158
Conservation Pricing	166
Water Reuse and Recycling	169
Conclusion	176
X. A DESCRIPTION OF THE MODELING TOOL	177
Introduction	177
Model Inputs	181
Simulating the System	183
Model Outputs	185
Conclusion	185

XI.	DEVELOPMENT OF RESOURCE STRATEGIES	187
	Water Supply Reliability: A Key Choice for the Region	187
	The Resource Options: Some Key Observations	198
	Resource Strategies	205
	Conclusions and Recommendations	241
XII.	RECOMMENDED FINAL PLAN CONCEPT AND IMPLEMENTATION ACTIONS	249
	Introduction	249
	Highlights of the Preliminary Plan Review Process	249
	Policy Objectives	255
	Recommended Water Resource Strategy and Implementation Actions	258
	Already Programmed Sources and Savings	261
	New Programs	264
	Potential New Sources	267
	Meeting Imminent Water Supply Needs in Specific Localities	271
	Formation of the Regional Water Providers Consortium	272
	Purpose, Mission, and Functions of a Regional Water Providers Consortium	273
	The Regional Consortium Role and Metro's Role	276
	Conclusion	277
	APPENDICES	278
	Appendix A: References	
	Appendix B: Development of Evaluation Ratings	
	Appendix C: Demand Forecasting Methodology	
	Appendix D: Description of Flavor Profile Analysis	
	Appendix E: Conservation Measure Screening Results	
	Appendix F: Summary of Responses to the August 1995 Regional Water Supply Plan Preliminary Report	
	Appendix G: Comments on the March 1996 Proposed Revisions to the Regional Water Supply Plan Preliminary Report	

I. INTRODUCTION

I. INTRODUCTION

PURPOSE OF THE REGIONAL WATER SUPPLY PLAN

The Regional Water Supply Plan (RWSP) provides a comprehensive, integrated framework of technical information, resource strategies and implementing actions to meet the water supply needs of the Portland metropolitan area to the year 2050. Twenty-seven of the region's municipal water providers and Metro collaborated for more than three years to develop the plan. The planning effort and final report reflects extensive input offered by citizens and stakeholders during all phases of the project. Implementation of the plan will be coordinated by a newly formed Regional Water Providers Consortium.

Throughout the project, many key factors (e.g., on-line supply facilities, demand forecasts, regulations) continued to evolve. The cooperative planning effort was versatile and able to respond to the changes. Circumstances will continue to change in the future. Thus, the plan must be dynamic and flexible. It must be reviewed and updated with sufficient frequency to respond to changing conditions, priorities, and public values. The plan should not be viewed as a static "blueprint" which will be carried out over the next several decades. Rather, plan implementation will be "iterative" in nature. This means that as plan implementation proceeds, key issues will be monitored continually and new information will be incorporated into periodic future plan revisions and implementation phases.

This plan represents a new era of cooperation and collaboration among the region's municipal water providers, and between the providers and the Metropolitan Service District (Metro). Formation of the Regional Water Providers Consortium to carry out the plan is a major part of the legacy yielded from this effort.

HISTORY OF THE REGIONAL WATER SUPPLY PLANNING EFFORT

The Portland, Oregon, metropolitan region is located on the lower Columbia River, where the Willamette River joins the Columbia. Its urban area is made up of 3 counties and 24 cities with a combined 1990 population of 1,138,000. This population is growing.

The region is served by a number of different surface and groundwater sources. The water supply system operated by the City of Portland currently supplies about half of

the population; the rest are served by a variety of sources, most notably the Clackamas River, the Trask River/Tualatin River system, and groundwater.

In 1989, a number of the region's water providers convened to discuss future water supply issues. It was agreed that the region was going to face future supply shortfalls given current supplies, use patterns, and growth projections. A group called the Regional Providers Advisory Group was formed which met on a monthly basis and had about 35 members.

In January 1991, the Portland City Council adopted a resolution directing the Portland Water Bureau to work with the region's other water providers to begin addressing regional water supply issues. In cooperation with the other providers, the Portland Water Bureau contracted with consulting firms to complete three studies. These "Phase 1" studies projected future regional water demands, evaluated potential regional water source options, and identified water conservation opportunities for the City of Portland retail customer base. Completed in February 1992, the studies found that:

- Water demands would increase significantly throughout the region;
- Existing supplies would not meet all of these demands;
- Conservation could play an important role in meeting regional water needs; and
- New sources of water and efficient transmission systems offered the potential to meet these increasing needs.

The Phase 1 "Water Source Options Study" evaluated 29 different water source options that could potentially be developed to serve the Portland/Vancouver metropolitan area's water needs. This was a comprehensive study, considering such sources as interbasin diversions from the Santiam system, the Little Sandy River, the Lewis River, a variety of groundwater sources, and even ocean desalination. The report ranked these sources against a predetermined set of criteria. The evaluation concluded that six source options were worthy of additional analysis and should be carried forward to a second phase Regional Water Supply Plan (RWSP).

After the Phase 1 studies were finalized, the Regional Providers Advisory Group (RPAG) distributed summary reports and held workshops, roundtable discussions, and briefings throughout the region to receive public input on the Phase 1 results. These

communications assisted in determining the issues to be addressed by a potential Phase 2 planning effort. The public input was incorporated into a scope of work for a Phase 2 RWSP.

The RPAG determined that Phase 2 must provide clear guidance on how to meet regional water demands to the year 2050. Phase 2 must also provide phased implementation strategies for regional water demand management programs, transmission and systems efficiency, supply development, and institutional relationships. Public involvement should be a key component of the planning effort.

A preliminary scope of work to complete a regional water supply plan was developed by the regional providers. Through a request for a statement of qualifications process, a briefing for potentially interested consultants, and a request for proposals, a group of regional water provider representatives and several technical experts selected a team of consultants led by the firm Barakat & Chamberlin, Inc. (BCI). BCI was to manage the development of an *integrated water supply plan* for the region. This process enabled regional providers to validate and expand on the necessary scope of work and identify expenditures needed to complete the project.

Twenty-seven of the region's water providers signed an intergovernmental agreement (IGA) in April 1993 to fund and manage the project. Project participants include 16 cities, 8 water districts, two public utility districts, and one joint board. In 1994, the Metropolitan Service District (Metro) became the 28th project participant.

PROJECT PARTICIPANTS

The 28 project participants are as follows:

City of Beaverton	Raleigh Water District
Canby Utilities Board	Rockwood Water PUD
Clackamas Water District*	City of Sandy
City of Gladstone	City of Sherwood
Clairmont Water District*	South Fork Water Board
Damascus Water District	City of Tigard
City of Fairview	City of Troutdale
City of Gresham	City of Tualatin
City of Hillsboro Utilities Commission	Tualatin Valley Water District
City of Forest Grove	West Slope Water District
City of Lake Oswego	City of Wilsonville
City of Milwaukie	City of Wood Village
Mt. Scott Water District	City of Portland
Oak Lodge Water District	Metropolitan Service District (Metro)

*The Clackamas and Clairmont Water Districts have recently merged to form Clackamas River Water.

The region's municipal water providers elected to participate in the Phase 2 RWSP for a variety of reasons, including:

- **Economies of scale:** The overall cost of performing this type of analysis was much less expensive when done regionally than when done by individual agencies.
- **Understanding the “big picture”:** Examining issues in a regional, sub-regional, and hydrologic sub-basin context provides an understanding of complex, interconnected issues that extend beyond jurisdictional and service area boundaries.
- **Facilitating program and project development:** Using the IRP approach helps ensure the success of regional demand management efforts and reduces the risks associated with permitting supply projects.
- **Facilitating public involvement and decision making:** The IRP process incorporates public values into the analysis, and displays the benefits,

costs, impacts, and risks of alternative water supply futures in ways people can understand.

- Demonstrating accountability as public service providers: Participating in this planning effort shows that public service providers can plan and operate regionally as responsible water providers.

Project costs were apportioned to each participating water provider on the basis of projected growth in peak day water demands. The IGA created a Participants Committee that has met monthly during the life of the project. Project participants have delegated certain project management responsibilities to a six-member Steering Committee that meets twice monthly, and is made up of two members each from Washington, Multnomah, and Clackamas Counties. The Portland Water Bureau has administered the project contract on behalf of the provider participants, and has assigned professional planning staff to provide specific project management and coordination services for the project, as authorized through the IGA and the contract.

AN OVERVIEW OF INTEGRATED RESOURCE PLANNING

The Phase 2 RWSP applies the techniques of Integrated Resource Planning (IRP). IRP is a nontraditional approach to long-term water resource issues. IRP represents a departure from "business as usual." It is a logical way to tackle the wide range of interconnected issues that affect, and are affected by, water resource planning.

IRP is very inclusive. It begins with the premise that a wide range of traditional and innovative supply-side and demand-side (conservation) resources must be considered. IRP encompasses a variety of techniques to help utility planners determine the appropriate mix of resources for meeting customer needs. It develops resource strategies that reflect future uncertainty and seek to achieve clearly-defined policy objectives. It provides information on potential consequences and aids in judging the value of tradeoffs among the strategies. IRP, when properly applied, is a process that leads to better long-term decisions.

IRP is as much a way of thinking about resource planning as it is a specific set of techniques. While there are particular planning components that characterize an IRP process, their application should not be dogmatic and must not ignore local conditions. IRP reflects a planning philosophy which eschews rules of thumb and recognizes the value in making explicit that which underlies most planning results, namely that decisions must strike a balance between often-conflicting objectives. IRP

strives to carefully analyze and present these tradeoffs to facilitate better long-term decisions.

IRP has its roots in the electric utility industry, where it emerged in the 1980s due to the convergence of an increasing cost structure, more prominent environmental concerns, high risks due to future uncertainties, and the emergence of demand-side management and a variety of new and innovative supply sources, such as cogeneration and wind power. IRP evolved as a way evaluate these competing demand-side and supply-side options.

The water supply industry is now facing many pressures that are similar to those that electric utilities have faced. Costs are increasing rapidly for a variety of reasons; environmental concerns are becoming paramount; innovative sources of supply such as water transfers, various types of conjunctive use, re-use, and desalination are being considered; water conservation is becoming an integral resource management tool; and future uncertainties are multiplying.

In some important ways, supplying water is even more complex than supplying electricity. For example:

- Unlike electricity, water is a limited resource with important uses that compete with urban consumptive demands. Thus, for example, a gallon of consumed water is not available for the many critical in-stream uses.
- While electricity quality is at most a minor issue for resource planners, water quality is as central to the service being provided by water purveyors as is quantity.
- Water supply decisions affect and are affected by a range of other issues ranging from wastewater effluent to land use to watershed management.
- Because of these and other concerns, the water supply industry faces a profusion of vexing uncertainties.

These pressures and complexities all point to the need for new planning paradigms to guide the industry. As a result, the industry is becoming more aware of and interested in IRP. The planning efforts of particular water agencies are beginning to reflect IRP principles, and an increasingly large body of water IRP literature is developing.

Many water agencies are beginning to work collaboratively to address complex regional issues that transcend the traditional utility boundaries. The IRP process lends itself to this type of regional planning. The Portland Regional Water Supply Plan distinguishes itself not only as one of the most comprehensive applications of water IRP that has been undertaken to date in the U.S., but also as a unique attempt to develop a truly regional water supply plan.

II. THE REGIONAL WATER SUPPLY PLAN: AN OVERVIEW

II. THE REGIONAL WATER SUPPLY PLAN: AN OVERVIEW

The scope of the Regional Water Supply Plan (RWSP) is comprehensive. It includes the following major elements:

- (1) **Public Information and Involvement.** An active, ongoing, and varied public information and involvement program.
- (2) **Policy Objectives.** Development of policy objectives that reflect the important regional values that this plan must attempt to meet.
- (3) **Demand Forecast.** Development of a logical and defensible demand forecast for the region.
- (4) **Supply Sources.** Evaluation of five potential regional supply sources.
- (5) **Transmission.** Identification and evaluation of potential transmission system improvements and expansions.
- (6) **Conservation.** Identification of a broad range of voluntary and mandatory demand management and conservation options available to the region.
- (7) **Resource Strategies.** Development and evaluation of integrated resource strategies based on the information developed in the foregoing elements. A sophisticated modeling tool was developed to assist this process.
- (8) **Implementation.** Identification of short-term and long-term actions that the region must undertake to ensure that the needs of the regional water providers and their customers are met throughout the planning period, which runs through the year 2050. This has included a preliminary assessment of possible institutional changes in the delivery of water service to the region's consumers.

Figure II-1 provides a schematic diagram of the major RWSP elements.

Figure II-1
Regional Water Supply Plan
Overview

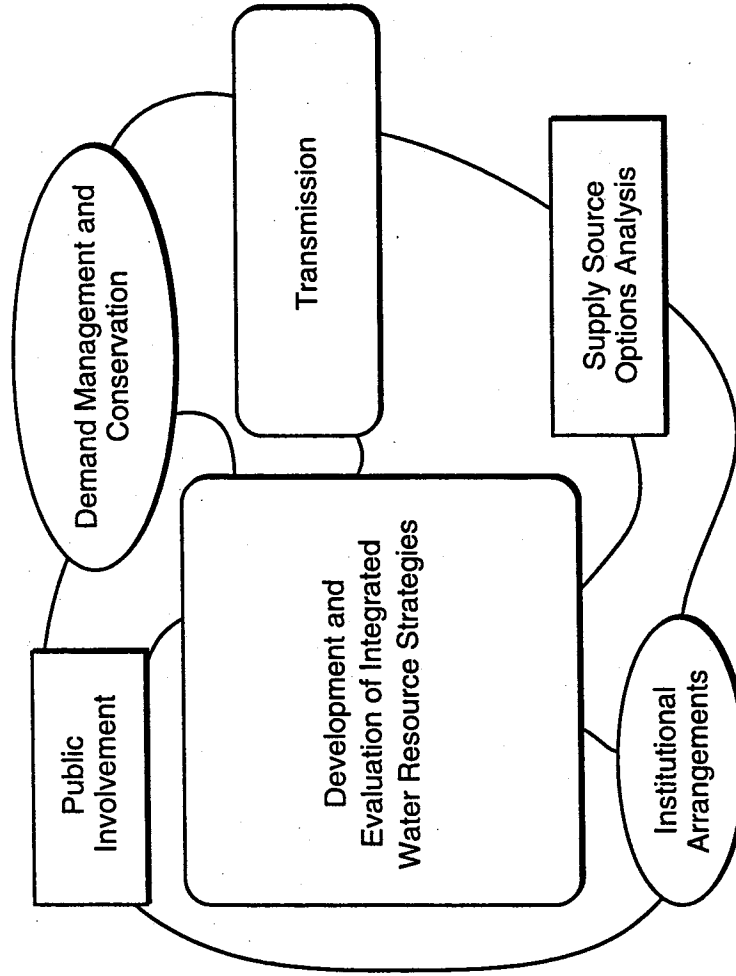

Chapters of this document provide descriptions of all RWSP elements. For most of these, more detailed documentation has been prepared in the form of interim reports or technical memoranda over the course of the project. These are listed in Appendix A. Arrangements to review these documents may be made through participating water providers.

POTENTIAL RESOURCE ADDITIONS

The key resources that are being considered to meet the region's future needs are as follows:

- **Conservation and Demand Management.** The participating water providers consider water conservation an important resource to meet future water supply needs. Many of the providers have already implemented conservation programs, including a variety of educational efforts, the provision of plumbing fixture retrofit kits to customers, and efficient and landscape workshops regionwide. The Columbia-Willamette Conservation Coalition, formed in 1993, allows agencies to share information on conservation efforts and to coordinate conservation programs and messages. A number of the water providers in the Portland Metropolitan area have also implemented increasing block rate structures that encourage users to reduce their overall summer water use.

As described below in Chapter IX, the RWSP evaluated a wide variety of additional conservation programs and rate options. Water reuse and direct use of nonpotable sources are also considered to a lesser extent.

- **Bull Run Dam 3.** The City of Portland currently owns and operates two reservoirs on the Bull Run River. The RWSP evaluated development of a third dam. At a maximum dam height of about 400 feet, this project would provide an additional 67,520 acre-feet, or about 22 billion gallons of storage capacity —more than double the existing reservoir storage in the watershed. The reservoir pool would cover 466 acres. It is estimated that the average daily peak season availability from the Bull Run source would increase by about 134.8 mgd (with 95% annual reliability). Maximum daily delivery capacity is estimated to increase by 270 mgd.

- **Expanded Use of the Clackamas River.** Several new or expanded Clackamas River water supply facilities are already planned for completion within the next 10 years. A total of 22.5 mgd from these projects is included in the baseline capacity assumptions for the regional plan.

Aside from these near-term expansions, the RWSP evaluated several ways to further expand existing diversions and treatment plants by up to about 83 mgd.

- **The Willamette River.** Currently, the Willamette River is not used as a municipal water source for the Portland metropolitan region. Upstream, the river is used for municipal purposes by the City of Corvallis. The RWSP evaluated the possibility of a new river intake and treatment plant on the Willamette. The maximum capacity currently being considered is about 160 mgd.
- **Columbia River.** Currently, the Columbia River is not used as a drinking water source in the Portland metropolitan region. However, the river supplies water to upstream Washington cities such as Kennewick, Pasco, and Richland, and also serves St. Helens, Oregon, located downstream from Portland. The RWSP considered development of an intake facility and treatment plant on the Columbia River. The maximum capacity currently being considered is about 105 mgd.
- **Aquifer Storage and Recovery.** Aquifer Storage and Recovery (ASR) is a water management approach involving surface water stored in underground aquifers (water-bearing rock strata), and then extracted for later use. This approach was considered as part of the RWSP.

Aquifer storage has certain advantages over surface water reservoirs. These include lower evaporation losses, potentially large storage volumes, and potentially fewer and less damaging environmental impacts. In the Portland region, ASR could help to meet peak season demands, provide emergency backup system benefits, and improve water quality by lowering temperatures in supply distribution systems during summer.

Currently, there are no ASR projects in the Portland region, but the Joint Water Commission and the Tualatin Valley Water District have

sponsored studies and development of an ASR project concept. The project, which would be located in Washington County, is also part of the regional water supply planning effort. The Mt. Scott Water District in Clackamas County is also conducting a study to see how ASR might meet a portion of its supply requirements.

ASR source water could come from any of the region's current or potential surface supply sources. Generally, surface waters would be diverted and stored underground during the high-flow months (e.g., winter, spring) when municipal demands are relatively low and excess water (under existing or future water rights) and treatment plant capacity is available.

Two representative ASR sites were evaluated as part of the RWSP. One site is located in the Powell Valley area southeast of Gresham. The second site is located in the Cooper-Bull Mountain area about four miles to the southwest of the City of Beaverton in Washington County. Each of these sites is believed to be able to consistently deliver 20 mgd over the summer season.

THE REGION'S NEED FOR NEW RESOURCES

A key conclusion of the RWSP is that, *with current resources and facilities, supplemented by facility additions to which the region's providers have already committed, the earliest point at which region will need major new resource additions will be around the year 2017.* This point is illustrated in Figure II-2, which shows a simple comparison between available supplies and peak-day demands under extreme weather conditions, assuming no additional conservation programs. The “crossover point” for the highest estimated demand occurs around the year 2017. Active conservation program efforts by providers can put off this need until at least the early-to-mid 2020s.

This does not imply that there is no work to be done until that time. There is, in fact, much to be done, as is discussed in the remainder of this document and summarized in Chapter XII.

Figure II-2

Comparison of Regional Peak-Day Demand To Existing and Committed Supply

Portland Metropolitan Region
1992--2050: All Customer Classes

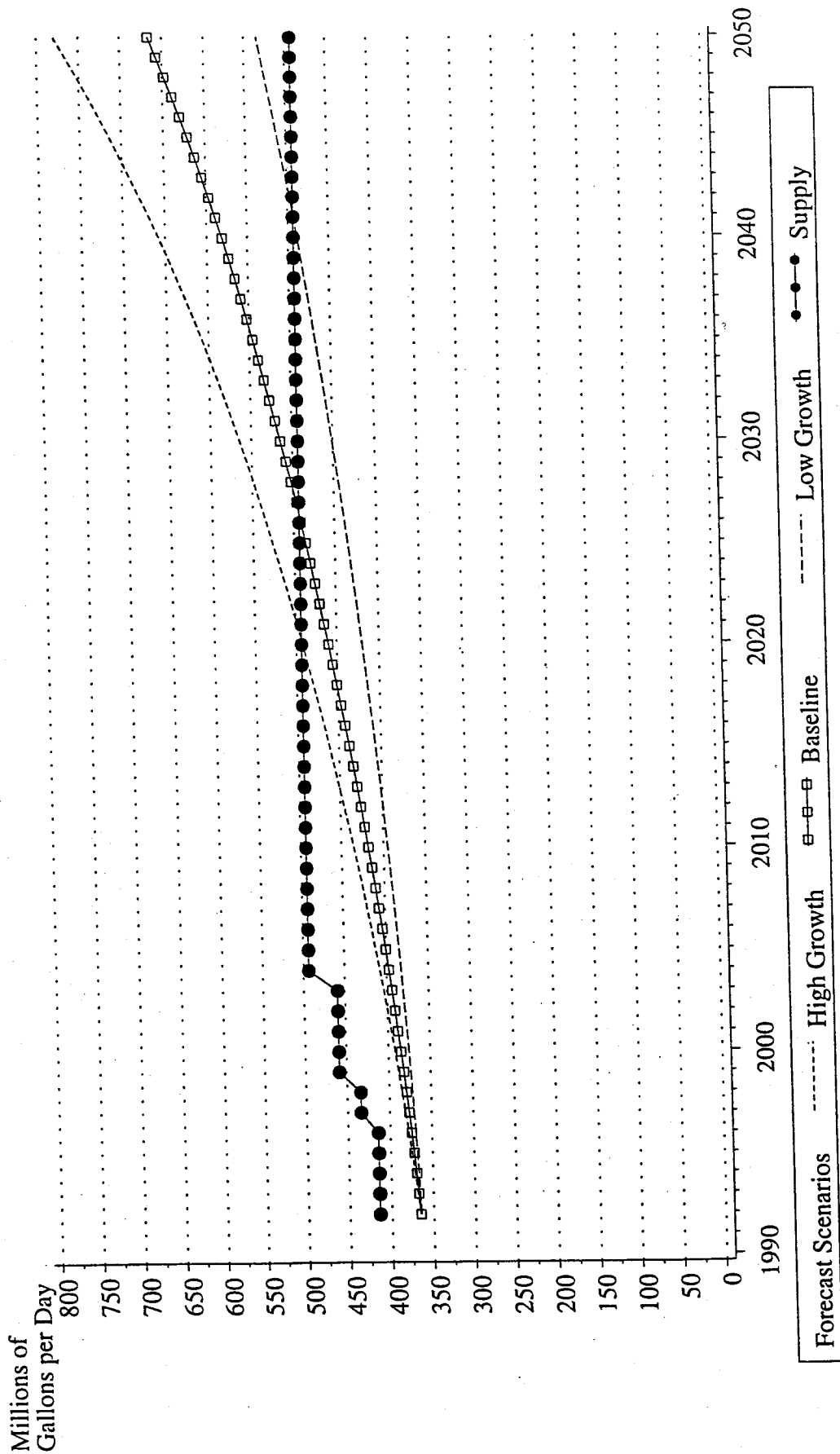

**III. PUBLIC INFORMATION AND INVOLVEMENT IN THE
REGIONAL WATER SUPPLY PLANNING PROCESS**

III. PUBLIC INFORMATION AND INVOLVEMENT IN THE REGIONAL WATER SUPPLY PLANNING PROCESS

Public information and involvement (PI&I) has been a cornerstone of the Regional Water Supply project (RWSP). Water provider participants demonstrated their commitment to PI&I by making it a key element of the project's scope, and by dedicating substantial fiscal and staff resources to the effort.

In September 1993, a Public Information and Involvement Plan was developed specifically to support the preparation of the preliminary RWSP. (The PI&I strategy for review and refinement of the preliminary report is described in Chapter XII.) The PI&I Plan addressed two types of activities:

- First, public outreach strategies to inform citizens about the region's water systems, current and future water needs, and future water resource alternatives.
- Second, a host of activities to seek input from citizens and stakeholders at key points in the process (e.g., project scoping, analysis of options, identification of key values and priorities, and design of integrated water supply strategies).

The PI&I plan was designed to reach various audiences through a mix of activities. Some activities targeted the general regional population, while others involved those with specific interests. Through this process, providers also attempted to promote consensus-building concerning the process and findings of the Regional Water Supply Plan. Some of these key activities are listed below.

PROJECT SCOPING

Water Supply—2050

This report summarized Phase I study findings and was distributed to 2,500 stakeholders in the winter of 1992.

Public Workshops

- Clackamas County—April 27, 1992
- Multnomah County—April 28, 1992
- Washington County—April 29, 1992

Roundtables

- Economic and Business Interests—July 6, 1992
- Land Use and Planning Agencies—July 7, 1992
- Environmental Interests—July 22, 1992

REGIONAL WATER SUPPLY PLAN

Regional Water Supply Plan participants provided numerous opportunities for the public to ask questions and present opinions on water supply issues throughout the planning process. This input helped the water providers to identify public values and priorities on how to best meet future water supply needs, and to formulate and evaluate the resource strategies.

Surveys and Interviews

Stakeholder Interview Report, October 1993

A series of 84 interviews was conducted with a variety of community leaders, organizational representatives, and citizens to ascertain their views on issues related to water supply in the region.

Public Opinion Research Study, March 1994

This statistically-valid survey of 900 residents in the tri-county region identified different levels of understanding and priorities relating to existing and future water resource options and conservation opportunities for the region.

The Value of Water Supply Reliability—A Contingent Valuation Survey, May 1994

A “contingent valuation” survey of more than 600 tri-county residents helped determine the value residential customers place on water supply reliability, specifically how much they were willing to pay to avoid water shortages of varying magnitudes and frequencies.

Regional Water Supply Plan Questionnaire

More than 400 people completed this questionnaire regarding citizens' views about tradeoffs among key values and priorities for meeting future water supply needs. The survey was conducted at the Oxbow Park Salmon Festival on October 15 and 16, 1994 and at the Energy Fair on November 20, 1994.

Public Meetings, Workshops, Forums

County Workshops

- Clackamas County—February 22, 1994
- Multnomah County—February 23, 1994
- Washington County—February 24, 1994

Regionwide Workshops

- August 9, 1993
- July 14, 1994
- June 22, 1995

Focus Groups

Two were conducted in June 1995 to gain a deeper understanding of the feelings of area residents about critical supply issues.

Briefings and Meetings

More than 100 presentations on the Regional Water Supply Plan were made to interested agencies, organizations, and citizens since the process began in 1992. Some of these organizations include:

- Oregon Senate Water Policy Committee
- Rotary Lions and Kiwanis Clubs
- Downtown Woman's Study Group
- Regional City Councils, District Boards and Metro Council
- Bull Run Community Association
- League of Women Voters
- Neighborhood Associations and CPOs
- Portland Energy and Environmental Commission
- Recycling Advocates
- Washington County Business Forum
- Oregon Water Resources Commission

Newsletters, Bill Inserts, and Informational Materials

Regional Water Supply News

Hundreds of interested citizens and a series of stakeholder groups have received RWSP newsletters (Winter 1994, Summer 1994, Summer 1995.) These newsletters informed citizens about the plan and upcoming participation opportunities. The mailing list of interested citizens has grown to 3,678.

"Earn a Million Thanks" Bill Insert

This and similar information pieces were mailed with the water and sewer bills of the Portland Water Bureau and other providers. The bill inserts provided an overview of the plan, and had a clip-and-mail form for those interested in more information. Over 2,000 citizens returned the form to request more information or sign up for the mailing list.

A "Snapshot" of the Regional Water Supply Plan

Since April 1995, any citizen requesting more information about the plan, either in response to the newsletter or bill inserts, received this short project overview. About 1,700 people requested this piece.

Regional Water Supply Plan Fact Sheets

For those interested in more details about the project, fact sheets were made available on the following topics:

- Existing water supplies
- Regional water demand forecasts
- Integrated resources planning approach
- Aquifer storage and recovery
- Bull Run Dam Number 3 option
- Columbia River option
- Willamette River option
- Clackamas River option
- Conservation opportunities
- Water reuse and recycling

Metro Activities

In 1994 and 1995, Metro has referenced the Regional Water Supply Plan project as a part of the Region 2040 materials.

Other Public Involvement Activities

Regional Water Supply Plan Slide Show

This show was developed to provide comprehensive, visual information on the RWSP. It has been used for many presentations made during the course of the planning effort.

Display Booths at County Fairs

The Regional Water Supply Plan provided display booths at each county's fair during the summer of 1995. The booths provided project information, and gave citizens an opportunity to ask questions and present their views on the region's water supply future.

Cable TV Programs

- Water Forum—May 7, 1992/July 13, 1995/August 3, 1995
- Washington County Forum—May 1995

Regional Water Supply Plan Video

A video about the project is now available for use by project participants and other interested citizens and organizations. It provides an overview of the project and information regarding water resource options and choices.

HIGHLIGHTS OF PUBLIC INPUT

Public input has helped identify key public values and priorities throughout the planning process. Key values expressed include concerns about:

- Costs
- Water quality
- Reliability of water supply systems
- Preventing environmental impacts
- Addressing the challenges of population growth

Specific activities yielded the results that follow.

Stakeholder Interviews

Stakeholders and community leaders throughout the region provided the following inputs:

- The Regional Water Supply Plan project is both appropriate and well-timed given current growth trends and the importance of water to the region.
- Cost and environmental impacts of potentially new supply options are important considerations for review during the planning process.
- Opportunities for cost savings should be pursued.
- Participants must work closely with environmental organizations, and state and federal agencies to assure timely resolution of serious environmental issues.
- Water supply savings through conservation should be the starting point for examining future options. The public will strongly support conservation to reduce the need for new supplies and meet environmental objectives.
- In examining new water supply sources, start with the best raw water quality.
- “Local” options are preferred.
- Consolidation of provider agencies can promote economies of scale and help convince the public that water is being managed cost-effectively.
- The public is currently not very interested in long-term water supply issues and needs to be informed about these issues and the study.

Public Opinion Survey

Some of the insights provided by the random survey of 900 residents from the tri-county region include:

- A significant portion of respondents (42%) throughout the region are unaware of their drinking water source.
- Citizens concur that the quality of the raw water source is important.

- Nine out of ten residents are willing to accept a different water source in the future. Residents claim to be less willing to change providers.
- Of the resource options being considered in the RWSP, conservation received the strongest rating and 85% of residents surveyed report that they felt they currently conserve water. New source options under consideration received neither strong endorsements nor flat rejections. Supply sources were rated in this order: Aquifer Storage and Recovery, Bull Run, Clackamas, Trask/Tualatin, Columbia, Willamette.
- Various environmental impacts were of concern depending on the source being considered. Over half of all those surveyed, however, felt there was not an impact or did not know if there were impacts for the sources being considered.
- The top three reasons residents gave for supporting a new water supply option were concerns about water shortages, maintenance and improvement of water quality, and lower costs. The top three reasons given for opposing new water supply option were: costs, water quality, and environmental impacts. Concern levels varied depending on the source option and the issue.

Contingent Valuation Survey

- Citizens throughout the region stated a high willingness-to-pay (WTP) for system reliability (or avoidance of shortage and curtailment). Residents of Clackamas County indicated a slightly lower WTP than Multnomah and Washington County residents.
- Citizens did not rank water shortage concerns very high in importance compared to a host of other social, economic, and environmental concerns.

Mail-in Responses

Citizens have mailed in many comment forms from the *Water 2050* report, *Earn a Million Thanks* bill insert, and *Snapshot* information piece. Some concerns are specific, such as questions about why one river system is being considered and not another, or

suggesting specific conservation practices and more public input. Other concerns address the project more generally.

Focus Group Research

Two focus groups explored the values, interests, and views of the region's water customers concerning tradeoffs required in meeting future water needs and customer's own drinking water needs. Some key findings are:

- Customers are interested in taking a balanced approach to planning the region's future water supply. They state that achieving a balance will prove most credible with the public. Customers appear willing to accept some changes. Maintaining current water quality and drinking water availability levels is viewed to be important.
- Reliability of the water supply is a critical issue. At a minimum, residents want secure, reliable water for drinking and washing. Most are willing to give up discretionary uses of water, such as washing the car or watering the lawn *in times of drought*.
- Residents generally value water conservation but are more likely to practice conservation aggressively in times of water shortages.
- Residents are also not willing to trade away irreversible or significant environmental impacts to ensure a reliable water supply or maintain their current water source. Most focus group participants understand that some environmental impacts may result from developing the region's future water supply, but minimizing these impacts is a clear priority.
- Focus group participants are willing to pay more to ensure the region's future water supply. Some cost increase to avoid serious environmental impacts is acceptable, but, as with most of the tradeoffs involved with selecting a water supply, there are limits.
- Focus group participants expressed concern about the accountability of water providers and the quality of the delivery system.
- Residents are interested in knowing more about the planning process and would like to remain informed about the Regional Water Supply Plan.

INCORPORATING PUBLIC INPUT INTO THE PLAN

As the foregoing discussion has shown, there has been, throughout the planning process, a great deal of information exchanged between project participants and interested citizens, organizations, and decision makers. Over 300 persons have received regular notification of committee meetings and documentation of ensuing discussions. Approximately 3,300 citizens have received updates and invitations to submit feedback through newsletters, bill inserts, and other information pieces related to the project. In turn, project participants received input from over 3,200 people through surveys and public workshops or briefings.

A major challenge facing the project participants has been to make complex technical, environmental, and socioeconomic issues accessible to interested citizens. Understanding key public concerns helped participants to provide information on topics of interest. Participants made special efforts to provide information at appropriate levels of detail and frequency.

Participants also made it a priority to *listen to the public*. Based on the types of issues previously highlighted, several key public values and priorities have emerged and remained throughout the planning process. Key "themes" revolve around issues that people most care about. These include:

- Cost
- Equity
- Water quality
- Environment
- System reliability (i.e., prevention of shortages, resilience to catastrophic events)
- Efficient water use
- Implications of growth

Not surprisingly, these key issues reflect the diverse interests of the region's citizenry. The goal of the public involvement process has been to capture the range of interests and concerns held throughout the region, recognizing that some of these are complementary and others conflict with one another. The Participants took great care to ensure that key public values and priorities were considered in preparing the preliminary plan report.

This range of key public values and concerns contributed greatly to the development of a set of regional policy objectives developed specifically for the RWSP. The policy objectives, along with associated evaluation criteria, provided the framework used to design and evaluate the relative strengths and weaknesses of alternative resource options and configurations, as discussed in later chapters. The policy objective will also be used as guidance to implement the final RWSP. The next chapter describes these policy objectives, evaluation criteria, and implementing action.

Additional public involvement was undertaken upon release of the preliminary plan for public review in early September 1995. The six-month public review process included region-wide mailings, numerous briefings, and regional workshops for citizens and stakeholders. Each of the participating agencies held individual workshops and hearings as well. Feedback from the plan review process was used to craft plan revisions designed to satisfy concerns raised. (For details on the preliminary plan and revisions review process, refer to Chapter XII.)

**IV. REGIONAL POLICY OBJECTIVES, EVALUATION CRITERIA,
AND IMPLEMENTATION ACTIONS**

IV. REGIONAL POLICY OBJECTIVES, EVALUATION CRITERIA, AND IMPLEMENTATION ACTIONS

A typical integrated resource planning process identifies a set of diverse policy objectives. Some complement each other while others conflict with one another. The RWSP is no exception. In order to assess resource alternatives, regional providers engaged in a process to carefully define the policy objectives that resource development would seek to achieve. Regional policy objectives must capture the range of municipal water service issues that citizens, stakeholders, and decision makers care about most. Identifying these concerns and priorities provides a basis for evaluating different future resource paths for the region. Explicit tradeoffs among these competing objectives become critical. Policy objectives and associated measurable evaluation criteria must faithfully reflect the issues important to the region, and must be useful to policymakers in distinguishing among alternative resource futures.

The water providers did not attempt to prioritize policy objectives in preparing the preliminary plan. Rather, the preliminary plan presented several options that emphasized different sets of objectives, and provided recommendations favoring those resource alternatives that seemed to meet the most objectives. The preliminary plan made the tradeoffs among the options clear which was meant to stimulate regional discussion and decisions about which policy objectives are most important to the region.

The policy objectives and associated criteria have been revised to encompass key issues raised during public review of the preliminary plan. The revised set of policy objectives, evaluation criteria, and implementation actions listed below will be used to guide implementation of the final Regional Water Supply Plan. They will provide a framework for future alternatives assessment, decisions, and actions as outlined in Chapter XII, Recommended Final Plan Concept and Implementation Actions.

THE PROCESS TO DEVELOP REGIONAL POLICY OBJECTIVES

Project participants engaged in a lengthy collaborative process to develop policy objectives for this project. Public input contributed substantially to this process. As described in Chapter III, key public priorities include water shortage prevention, environmental protection, water quality, cost, efficient use of water, and others. Project participants drafted statements of policy objectives for each major topic heading.

Some of the policy objectives complement each other, while others compete or conflict. The complexity of the water supply planning and decision-making process is appropriately reflected in the broad range of policy objectives identified.

Policy objectives were used not only to evaluate alternative resource futures, but also to design them. The policy objectives provided key guidance during formulation of resource strategies for the preliminary plan.¹ The strategies presented in Chapter XI were designed to meet combinations of the objectives. This helped illustrate key tradeoffs associated with various water supply choices facing the region.

The project participants circulated draft policy objective statements for review by stakeholders and the decision-making bodies of each participating agency. Based on these reviews, the language of several of the policy objectives was revised prior to completion of the preliminary plan. As mentioned earlier, the policy priorities were refined again to reflect key issues and concerns raised during public review of the preliminary plan.

THE POLICY OBJECTIVES, EVALUATION CRITERIA, AND IMPLEMENTATION ACTIONS

Comparisons and analysis of tradeoffs among alternatives were facilitated by applying a set of measurable evaluation criteria. The criteria are not generally expressed in the same units. Indeed, insistence on such consistency is often counterproductive. Some are measured in dollars, others in percentages, and others in terms of water volume (acre-feet) or flow capacity (mgd). Many of the ratings are based on professional judgment or summarize a large quantity of technical information. Implementation actions were crafted as part of the plan revision process. They, in association with corresponding policy objectives, provide the basis for plan implementation actions set forth in Chapter XII of this report. These policy objectives and corresponding implementation actions provide a basis for setting certain work program priorities and monitoring plan implementation effectiveness. Each policy objective is associated with at least one evaluation criterion or implementation action. In several instances, a single evaluation criterion is associated with more than one.

The following discussion describes the policy objectives, associated evaluation criteria, and implementation actions that emerged from the process. The policy objectives

¹These terms will be defined and discussed in Chapter XI.

presented in tables and text are not weighted or presented in any particular priority order.

EFFICIENT USE OF WATER

Policy Objectives

- Maximize the efficient use of water resources, taking into account current and emerging conservation opportunities, availability of supplies, practicality, and relative cost-effectiveness of the options.
- Make the best use of available supplies before developing new ones.

Evaluation Criterion

- Total conservation volumes over the planning horizon divided by total demand over that same period.

Discussion

These policy objectives indicate the importance of water use efficiency to the region. Apart from the contribution that conservation and reuse make to other objectives, they are vital to this region in and of themselves. This widely held conservation ethic is an indication of the value the region places on responsible stewardship of water resources.

The evaluation criterion attempts to summarize the extent of conservation included in any potential resource path by determining the proportion of projected water demand that is offset by water conservation savings.

WATER SUPPLY SHORTAGES

Policy Objective

- Minimize the frequency, magnitude, and duration of water shortages through a variety of methods including development and operation of efficient water supply systems, watershed protection, and water conservation.

Evaluation Criteria

- Probability of *any* shortage.
- Probability of designated (e.g., 10% and 25%) shortages.
- Expected unserved demand.

Policy Objective

- Ensure that the frequency, duration and magnitude of shortages can be managed.

Evaluation Criteria

- Active raw water storage volume.
- The quotient of two quantities:
 - Sum, across all demand nodes, of the maximum amount of water that can be moved into the node via all possible routings; and
 - The average daily summer seasonal demand across all nodes.²

Policy Objective

- Ensure that decision makers retain the flexibility to select appropriate risk levels for peak event water shortages given applicable future conditions, constraints, and community values.

²The concept of a demand "node" is used in the *IRPlanner* model and will be explained in Chapter X. There are three nodes, each corresponding to one of the counties in the metropolitan region.

Implementation Actions

- Conduct, in the near-term, a region-wide discussion of issues and tradeoffs associated with developing water systems that will result in different risks (frequency, magnitude, and duration) of peak event shortages. Discuss the implications of selecting uniform or differing shortage probabilities in different parts of the region. Involve citizens and stakeholders in the discussion. Incorporate discussion outcomes in future plan updates.
- Take steps to identify actions that can be taken in the near term that will contribute to future flexibility in decisions regarding peak event shortage risk levels.

Discussion

These three policy objectives address different aspects of water shortage management. The first is concerned with minimizing future water shortages due to supply/demand imbalances. A shortage is an inability to fully serve demand. Traditionally, most water and other utilities have treated the risk of shortages as a constraint rather than a decision variable. That is, resource plans were developed to achieve a designated (and very high) reliability level.

As described above, one of the RWSP's premises is that shortage avoidance, as one of many regional policy objectives (albeit a very important one), must be traded off against other objectives such as minimizing costs and environmental impacts. Policymakers must understand the implications of choosing different future peak event supply shortages risk levels in order to make informed decisions.

A complete description of a water supply system's reliability characteristics is complex. Reliability is a function of available supplies, storage capacities, delivery capacities, treatment regimes transmission capabilities, the magnitude and spatial distribution of demands, and the manner the system operates. Future supply availability and demands are uncertain. Supply is a function of weather and streamflow conditions; it may also depend on future regulatory or legislative decisions. Demands reflect future growth and water use patterns and weather, among other things.

As a result, reliability is best described probabilistically. Figure IV-1 is a hypothetical cumulative frequency distribution of shortages for a particular future period.³ The

³This curve is analogous to the "exceedance curves" with which many water providers are familiar.

vertical axis shows the probabilities that shortages larger than the magnitudes shown on the horizontal axis will occur, given the assumed supply availability and demands for that period. Figure IV-1 also illustrates the three types of evaluation criteria used to measure the attainment of this objective. These include:

- *Probability of Shortage (POS)*: The likelihood of any shortage whatsoever. This is the point where the curve in Figure IV-1 intersects the vertical axis. For this hypothetical system, the POS is about 85%.
- *Probability of Designated Shortage (PODS)*: The likelihood of a shortage larger than a specified level. For the hypothetical system illustrated in Figure IV-1, the 10% PODS (i.e., the probability of a shortage greater than 10%) is about 70%.
- *Expected Unserved Demand (EUD)*: The expected percent shortage (i.e., the expected fraction of demand not met). In Figure IV-1, the EUD is 15%.

Figure IV-1
Example of Cumulative Frequency Distribution for a
Specific Future Period

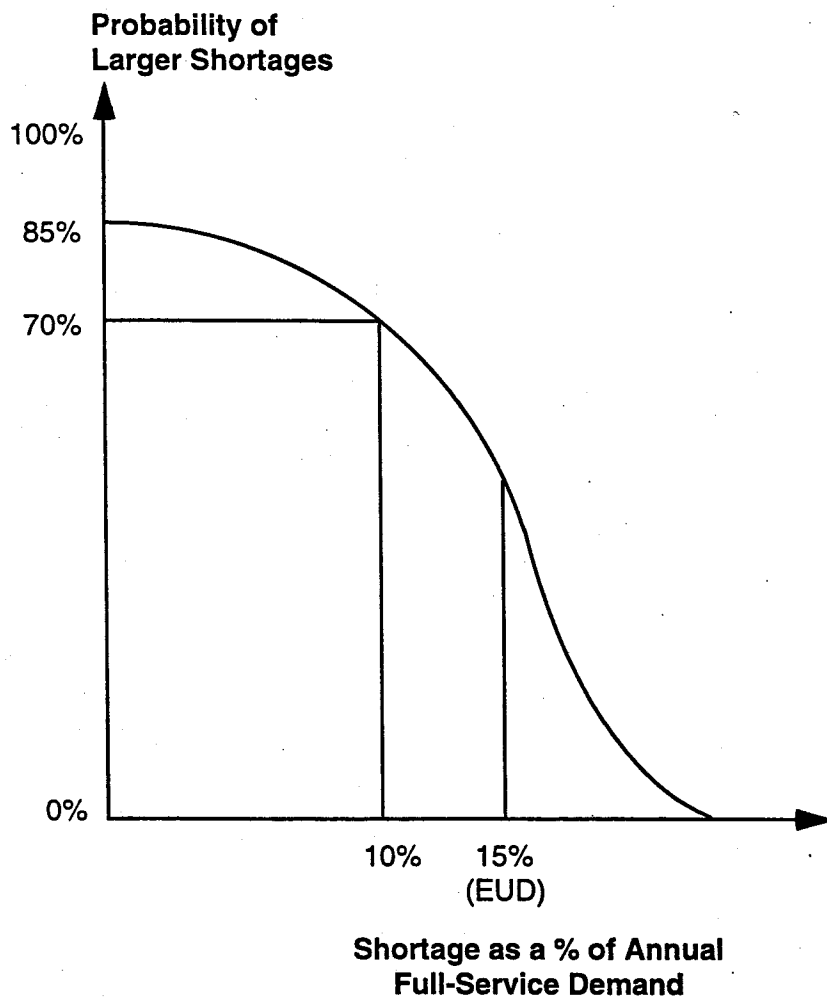

The complete specification of any of these indices must include:

- The future year;
- The portion of that year that is of interest (e.g., peak-day, peak season, year);
- The geographic area (e.g., the entire region or particular subregion); and
- The weather and streamflow conditions. For example, an index of reliability for the year 2020 might be the probability of a summer season shortage greater than 5% in Washington County under “typical” weather and streamflow conditions. Another measure of reliability might be the year 2040 expected unserved peak day demand for the entire region under the most severe historical weather conditions.

Chapter XI describes the manner in which these indices are applied to develop future resource strategies for the region that provide varying levels of reliability.

The second policy objective relating to reliability concerns the ability to operate the system in a manner that eases the impact of shortages that do occur. The first evaluation criterion is the volume of active storage in the region. Greater storage volumes allows the regional providers to better “spread” the impacts of a shortage over time.⁴ The second criterion attempts to summarize the system's “interconnectedness”. More regional transmission allows providers to move water where it is needed when it is needed, thereby alleviating severe impacts.

The third policy objective highlights the need for the region to recognize and address the tradeoffs associated with pursuing various levels of shortage avoidance. Cost tradeoffs, for example, are illustrated in Chapter XI. By conducting a region-wide

⁴As described in Chapter XI, the strategy-development process revealed that the future shortages with which the region must be concerned are all a function of peak day delivery capacity rather than volume over a peak season. In other words, the region will not need additional supply storage capacity even under adverse weather (e.g., hot and dry), low streamflow and high demand conditions, given existing and committed resources. Thus, on a regional basis, this index has limited usefulness in terms of measuring resilience against summer supply shortages.

Storage can be important in responding to catastrophic events that damage existing systems. In addition, local storage capacity can, however, be extremely valuable to individual providers in managing brief-duration shortages due to regional capacity constraints. Analysis of local storage capabilities and needs is beyond the scope of the Phase 2 RWSP.

discussion of the tradeoffs as prescribed in the milestone for this objective, the region will be able to address the issues and make informed decisions in a timely manner.

IMPACTS OF CATASTROPHIC EVENTS

Policy Objective

- Minimize the magnitude, frequency, and duration of service interruptions due to natural or human-caused catastrophes, such as earthquakes, landslides, volcanic eruptions, floods, spills, fires, sabotage, etc.

Evaluation Criteria

- Comparative scale re: vulnerability to catastrophic events, reflecting such factors as:
 - Proximity of facilities to potential catastrophic event locations
 - Availability of backup facilities
 - Physical capability to move backup source water to demand centers
 - Time needed to bring facility(ies) back on line
- The quotient of the following two quantities:
 - Sum, across all demand nodes, of the maximum amount of water that can be moved into the node via all possible routings; and
 - The average daily summer seasonal demand across all nodes.
- Expected unserved demand due to unavailability of either:
 - The Bull Run source; or
 - The next largest supply source

Discussion

The region's supply sources and facilities are subject to a variety of natural and human-caused events that could result in catastrophic failure. Several ways exist to measure this vulnerability. The first simply uses a comparative scale for each source option. The second measures the "interconnectedness" of the system. The greater the ability to

move water into each subregion, the greater the ability to withstand catastrophic loss of supply.

An indicator of the degree of robustness or “redundancy” in the regional supply system is the system's performance if it loses one of its major supplies. The third criterion measures this performance for the loss of the Bull Run, the region's largest current and future supply source, and for the loss of the next largest supply source.

WATER QUALITY

Policy Objective

- Meet or surpass all current federal and state water quality standards for finished water.

Implementation Action

- All source options will be treated to meet or exceed these standards.

Policy Objective

- Utilize sources with the highest raw water quality.

Evaluation Criterion

- Comparative scale, based on most current information.

Policy Objective

- Maximize the ability to protect water quality in the future, including support for and participation in watershed-protection and pollution-prevention based approaches.

Evaluation Criterion

- Comparative scale, re: ability to protect future water quality, reflecting factors such as:

- Protected watersheds
 - Public access
 - Land uses
 - Land ownership
 - Risks of accidents, such as hazardous material spills
 - Upstream contaminants
 - Dilution ability of the watershed

Implementation Action

- Formulate a strategy for identifying priority source protection issues and activities which are underway, or should be undertaken, to protect and enhance the raw water quality and watershed health of existing or potential regional water sources. Initiate, support, and/or participate in such efforts as warranted to achieve source protection and enhancement objectives.

Policy Objective

- Maximize the ability to deal with aesthetic factors, such as taste, color, hardness, and odor.

Evaluation Criterion

- Comparative scale, re: aesthetics.

Discussion

Identification by the region's providers of several policy objectives that deal with water quality reflects its importance to the region. A critical distinction must be made between finished (i.e., treated) and raw water quality. Raw water quality is measured prior to treatment. Finished water is consumed by customers. Health and aesthetic regulatory standards for drinking water apply to finished water only. The region is also concerned with the quality of its raw water supply, independent of the quality of the treated product. In addition, an objective addresses the ability to protect water sources and watersheds and prevent future quality degradation.

Most of the corresponding evaluation criteria are comparative scales based on detailed analysis of raw water quality and treatment requirements. The water quality and treatment analyses for each source are described in Chapter VII. The implementation action established for the third objective prescribes that the region's water providers take a proactive participatory approach toward achieving source water quality protection and enhancement objectives.

ECONOMIC COSTS AND COST EQUITY

Policy Objective

- Minimize the economic impact of capital and operating costs of new water resources on customers.

Evaluation Criteria

- Present value of utility revenue requirements (including capital and operating costs).
- Present value of societal costs, which is the sum of the present value of utility revenue requirements and direct out-of-pocket customer costs less the residual value of capital assets at the end of the planning period.

Policy Objective

- Ensure the ability to allocate capital and operating costs, e.g., rate impacts for new water supply, related infrastructure, and conservation water savings, among existing customers, future customers, and other customer groups, proportional to benefits derived by the respective customer group(s).

Evaluation Criterion

- The proportions of new resource and facility costs paid by existing ratepayers, future ratepayers, and other relevant customer groupings,

given the proportional benefits accrued by such customer groups in relation to expenditures for new water supply resources and facilities.

Implementation Actions

- Develop guidelines and methodologies with which to determine how capital and operating costs for new water supplies should be allocated at regional and/or sub-regional levels.
- Develop methodologies for identifying, anticipating, and addressing short- and long-term revenue impacts associated with implementation of conservation programs.

Policy Objective

- Maximize cooperative partnerships to co-sponsor projects and programs that provide mutual and multiple benefits.

Implementation Action

- Identify and pursue partnerships with other agencies and the private sector to cost-share and co-participate in plan implementation strategies.

Discussion

The first policy objective addresses the costs associated with each resource strategy. Costs are expressed as a discounted present value. Discounting is a commonly used technique that reflects the time value of money, and the fact that future costs must be discounted in order to compare them to current costs. A real (net of inflation) 3% discount rate was used in the RWSP.

The evaluation criteria distinguish between “utility” and “societal” costs. This is a common distinction that has been widely used by energy utilities and their regulators. Utility costs are the revenue requirements typically reflected in rates charged to customers. Major elements include operating and maintenance costs and debt service costs on capital investments.⁵ Societal costs are broader and reflect a project's total costs to society. In addition to costs reflected in rates, societal costs include customer

⁵It is assumed all capital investments are financed over a 30-year period at a 4 % real interest rate.

out-of-pocket costs for conservation investments. Societal costs are reduced by any end-of-period residual values of utility and customer investments.

The second policy objective addresses cost-equity issues and prescribes that those who benefit should pay and growth should pay for growth. The evaluation criterion would measure the ability of various financing strategies to meet this objective. Evaluation against this criterion must wait until institutional and financing arrangements are determined after the adoption of the final RWSP. A milestone is proposed to set in motion the formulation and evaluation of equitable financing strategies to meet the objective. Another milestone is suggested to ensure that the revenue impacts of conservation are recognized and addressed in an equitable manner.

The third policy objective emphasizes the importance, from both overall cost and cost equity perspectives to maximize the establishment of partnerships to co-sponsor successful plan implementation. The corresponding milestone assigns the region's water providers the task of identifying and pursuing partnerships and cost-share arrangements as appropriate to pay for mutual benefits.

ENVIRONMENTAL STEWARDSHIP

Policy Objective

- Minimize (i.e., avoid, reduce, and/or mitigate) the impact of water resource development on the natural and human environments.

Evaluation Criteria

- Comparative scale reflecting impacts on the natural environment. The natural environment includes:
 - Fish
 - Geotechnical and natural hazards
 - Threatened and endangered species
 - Wetlands
 - Wildlife and habitat
- Comparative scale reflecting impacts on the human environment. The human environment includes:

- Cultural resources
- Hazardous materials
- Land use
- Recreation
- Scenic resources

Policy Objective

- Foster protection of environmental values through water source protection and enhancement efforts, and conservation.

Implementation Action

- Demonstrate the role of water providers as environmental stewards through strategy formulation, priority setting, and participatory involvement in source protection and enhancement efforts (see WATER QUALITY section above).

Discussion

For the first policy objective, rating scores were assigned to each source option based on an extensive analysis of how ten environmental factors would be affected by implementation of the source option. In some cases (e.g., fish and land use), subcategories were first rated, and then combined. The five scales for the components of the natural environment were combined into a composite rating, as were the five human environment scales. The formula used to combine the ratings gives disproportionate weight to high (adverse) scores.⁶ This reflects the fact that adverse ratings on a single environmental dimension often has the potential of killing a project.

The second policy objective will help guide implementation of the plan by stating the region's water providers' commitment to participate in efforts to protect environmental values through appropriate source protection and enhancement efforts. The associated milestone prescribes that actions be taken to identify and support and/or undertake priority source protection and enhancement efforts.

⁶See Appendix B for a description of the development of the ratings.

GROWTH AND LAND USE PLANNING

Policy Objectives

- Be consistent with Metro's regional growth strategy and local land-use plans.
- Facilitate and promote effective Regional Water Supply Plan implementation through local and regional land use planning and growth management programs.

Evaluation Criteria

- Degree of ongoing coordination with Metro and local government planning entities.
- Incorporation of the Regional Water Supply Plan into Regional Framework Plan.
- Degree of consistency and compatibility between the Regional Water Supply Plan and relevant aspects of local comprehensive plans.

Implementation Action

- Work with local governments and Metro to identify and pursue opportunities to facilitate and promote plan implementation through regional land use plans, zoning codes, and growth management efforts (e.g., Region 2040, Regional Framework Plan, and periodic review of local comprehensive plans).
- Work with local governments and Metro to determine the location and extent of future growth and then utilize the plan to provide guidance for the provision of water service.
- Participate in efforts to incorporate water supply and resources issues into future land use and growth management decisions in efforts to promote community livability and resource sustainability.

This critical policy objective led the project team to closely coordinate with Metro throughout the project. As the project proceeded, both the providers and Metro saw the

value in Metro's more formal participation in the planning process, and Metro became a formal participant in the RWSP. As described below in Chapter V, the demand forecast is based on population and employment forecasts developed by Metro as part of the Region 2040 planning process. Ongoing discussions are currently underway regarding future roles of Metro and the providers.

The providers intend to continue close and ongoing coordination with Metro and local governments throughout the period of plan implementation, adoption of the Regional Framework Plan, and various plan updates. The role of land use planning and decisions can have a substantial impact on the success of the RWSP. It will be important that the RWSP and local/regional land use plans are consistent and compatible. Application of the evaluation criteria and carrying out implementation actions will take place during plan implementation.

FLEXIBILITY TO DEAL WITH FUTURE UNCERTAINTY

Policy Objective

- Maximize the ability to anticipate and respond to unforeseen future events and changes in forecasted trends.

Evaluation Criterion

- Number of possible resource paths included in a resource strategy.

Discussion

As detailed in Chapter XI, resource strategies take the form of probabilistic “decision trees” that provide the region with guidance on future actions as uncertainties are resolved. A strategy provides more flexibility if it facilitates provider responsiveness to different future events. To the extent a resource strategy includes early actions that limit flexibility by precluding different responses to different uncertainty outcomes, the strategy will be less flexible than one which involves a more incremental approach with multiple paths and options.

EASE OF IMPLEMENTATION

Policy Objective

- Maximize the ability to address current and future local, state, and federal legislative and regulatory requirements in a timely manner.

Evaluation Criterion

- Comparative scale, re: ability to meet current and future legal and regulatory requirements in timely manner.

Discussion

Each source option has particular legal and regulatory hurdles that must be dealt with prior to source development. Based on current understanding of these issues, a comparative "ease of implementation" rating was assigned to each source option. These are intended to reflect the anticipated difficulty of developing the source based on best knowledge of potential future constraints and opportunities.

OPERATIONAL FLEXIBILITY

Policy Objective

- Maximize operational flexibility to best meet the needs of the region, including the ability to move water around the region and to rely on backup sources as necessary.

Evaluation Criteria

- Active regional storage volume.
- Sum, across all demand nodes, of the maximum amount of water that can be moved into the node via all possible routings.

Policy Objective

- Ensure that the plan includes flexible strategies for meeting both sub-regional and regional water demands in the near-term and beyond.

Implementation Action

- Develop a strategy to meet imminent water needs in pertinent parts of the region in a manner consistent with the final long-range resource strategy. Assign the carrying out of this strategy a high priority.

Discussion

It is necessary for providers to be able to flexibly operate the system to best meet the region's needs. Two indicators of system flexibility are the volume of active regional storage that allows the region to better manage seasonal shortages,⁷ and the ability to move water to address short-term operational needs.

In addition, the plan must be flexible enough to ensure demands are met in the near-term and through the planning horizon.

CONCLUSION

The policy objectives, evaluation criteria, and implementation strategies discussed in this chapter have formed the basis of the design and assessment of alternative water futures for the region. They also provide a framework to guide future plan implementation. These statements have been developed through a lengthy, interactive process that has benefited from extensive citizen and stakeholder input. The competing nature of many of these objectives reflects the importance to the region of this decision and the broad range of values held by the citizenry.

⁷Again, it must be noted that seasonal shortages and regional storage volume will not be critical issues for the region. Local storage may be an important issue for particular providers.

V. FUTURE WATER DEMANDS IN THE REGION

V. FUTURE WATER DEMANDS IN THE REGION

INTRODUCTION

Obtaining a well-developed and defensible water demand forecast has been critical to the preparation of the RWSP. The demand forecast underlies the evaluation of water supply reliability for any resource configuration. This chapter describes the development of the RWSP demand forecast. The forecasting methodology is complex, and the description in this chapter is necessarily abbreviated. A more detailed presentation of the forecasting approach is presented in Appendix C.

Annual, seasonal, and peak-day water demand forecasts have been developed for the region as a whole and for each of the three counties. The forecasts were based on customized individual-provider population and employment projections provided by Metro's staff. These projections are consistent with forecasts developed as part of Metro's Region 2040 project. RWSP staff and consultants have coordinated closely with Metro staff throughout the process to ensure consistency.

KEY FEATURES OF THE FORECASTING APPROACH

Individual forecasts were developed for each of 47 providers. The projected growth in water demand for these providers were based on population and employment growth rates provided by Metro for each provider service area. These forecasts were then aggregated to county and regional levels consistent with the RWSP's focus on aggregated needs. The precision of these county and regional forecasting results is considerably higher than for individual providers. Table V-1 shows the providers included in the demand forecast, by county.

The forecast was conducted in four stages. For each provider, the first stage estimated a "status quo" forecast of sales per customer class for each water provider through 2050. Status quo forecasts presumed no change in historical per-account consumption. Customer classes include residential, commercial, industrial, municipal, agricultural, etc. The result of this stage was called the gross water demand.

The second stage estimated the effects of *naturally occurring conservation* on gross water demand. Naturally occurring conservation represents the reduction in water demand due to changes in water service technologies, building codes, appliance standards, and the competitive marketplace. This is conservation that will occur

regardless of conservation programs introduced by the providers. Net water demand is calculated by subtracting naturally occurring conservation from gross water demand.

**Table V-1
WATER PROVIDERS INCLUDED IN DEMAND FORECAST**

Multnomah County	Washington County	Clackamas County
Burlington	Beaverton	Boring
Fairview	Cornelius	Canby
Gresham	Forest Grove	Clackamas
Hazelwood	Gaston	Clairmont
Hideaway Hills	Hillsboro	Damascus
Interlachen	North Plains	Estacada
Lorna	Raleigh	Gladstone
Lusted	Sherwood	Glenn Morie/Mossy Brae/Skylands/ Southwood Park
Palatine Hills	Tigard	GNR Corp/Green Valley/Skyview Acres
Pleasant Home	Tualatin	Lake Grove
Portland	Tualatin Valley	Lake Oswego
Powell Valley	West Slope	Milwaukie
Rockwood		Mount Scott
Sandy		Oak Lodge
Troutdale		Oregon City
Valley View		Rivergrove
Wood Village		West Linn
		Wilsonville

The third stage of the forecast estimated effects of increases in the price of water (after accounting for inflation) on reductions in water consumption. As water providers develop new sources of water and spend more to maintain existing systems, the price of water may rise. This will likely result in a lower per-account forecasted demand. "Price-net" water demand is calculated by subtracting this response to increasing water prices from net water demand.

The fourth stage estimated water demand on the peak day of the year for each water district. A critical concern of the region's planners and a key RWSP issue is the level of capacity required to meet peak day demand. Peak day demand was calculated by combining historically-based information on the ratio of peak day to average day demands with the forecast of price-net water demand for each water district.

The next four sections present each stage of forecast development in greater detail.

GROSS WATER DEMAND FORECAST

The objective of this stage was to generate a monthly forecast of sales per customer class for each water district through 2050. Two analyses were conducted for every customer class in each water district to determine: (1) an estimate of monthly sales per account; and (2) a forecast of the number of accounts.

In the first analysis, billing data were collected from each water district that described the number of customer accounts and monthly sales for each customer class prior to 1992. Many water districts have billing systems that bill customers for more than one month's water consumption. For example, bills sent in September may include water actually consumed in July and August. To ensure peak season forecasting reliability, it was desirable to know when water was actually consumed (on a monthly basis). For this reason, operations data on total monthly water diversions and treated deliveries were also collected from major water wholesalers. Econometric models were developed to link these operations data with retail sales for each water district. The results were historical monthly records of estimated sales per customer class.

Next, a series of econometric models was built that explain how variations in water sales per customer account were related to variations in seasonal water demand patterns and weather. First, sales per customer class were divided by the number of customers in that class to remove the effect of population growth from the historical record. Next, econometric models estimated the relationship between water consumption and three factors: (1) seasonal patterns, such as outdoor watering or irrigation; (2) temperature; and (3) precipitation. The forecast used these relationships to estimate sales per account under average weather conditions (i.e., sales per account driven solely by seasonal patterns). In addition, weather sensitivity analyses were conducted using simulated weather conditions based on the historical weather record.

The second analysis for the gross water demand forecast relied on Metro's population and employment forecasts, as discussed previously. Metro's regional forecast provides

high, medium, and low demographic projections for planners to use in estimating urban and transportation impacts of future economic and demographic trends. In addition to the medium forecast, alternative high and low growth scenarios were evaluated to investigate issues of uncertainty and risk. The medium forecast predicted that the region will add more than 1 million new residents by 2040. The high case projected a 2040 population level that is more than 300,000 residents greater than the medium case, while the low case projected about 400,000 residents fewer than the medium case.

To support the Regional Water Supply Plan, Metro developed provider-specific forecasts of households and employment based on the Region 2040 projections for Multnomah, Clackamas, and Washington counties. The provider-specific household and employment growth between 1992 and 2040 was translated into annual growth rates for water district residential and nonresidential customer classes. These growth rates were subsequently used to estimate the future number of accounts per customer class served by each water district. For the 2040—2050 period, the average annual growth rate through 2040 was applied.

Future growth rates and customer accounts were separately estimated for the low, medium, and high-growth case. This produced three forecast scenarios.

After the analyses were completed, forecasted sales for all customer classes in all districts were estimated by merging forecasted sales per account with forecasted customer accounts.

NET AND PRICE-NET WATER DEMAND FORECASTS

This section describes two analyses conducted to adjust the gross water demand forecast for market factors expected to affect future water demand that (1) represent relatively new market forces that the gross demand forecast's historical basis did not reflect; and (2) are too subtle in the short-term to capture reliably in an econometric framework. The first market factor is naturally occurring conservation, and the second is consumer response to increases in the real price of water.

Changes in water services technologies, whether through building codes, appliance standards, or the competitive marketplace, affect per-customer water consumption over time. Technological change will also reduce per household usage as processes and equipment efficiently utilizing scarce resources replace less efficient equipment types. All these changes, whether driven by the marketplace or by regulation, are called

naturally occurring conservation. Naturally occurring conservation covers the installation and use of all water saving technologies independent of provider-sponsored programs.

The approach to developing estimates of naturally occurring conservation relied on the projected turnover (or "vintaging") of buildings and equipment. The resulting model combined information on the expected lives of buildings and equipment, the market presence of water using equipment, the relative market shares of efficient and inefficient equipment within each equipment type or end use, and the expected consumption of each end use. Estimates of water usage change over time with the growth of building stock in each water district, the natural decay of existing building stock, and the turnover of equipment.

Estimates of naturally occurring conservation focused primarily on residential and commercial indoor end uses, such as showers, toilets, dishwashers, and clotheswashers. Efficiency standards in residential and commercial toilets, faucets and showerheads have increased throughout the 1980s and 1990s.⁸ Clotheswashers and dishwashers are not currently covered by plumbing codes, but clotheswashers are affected by energy standards reducing the amount of water used. Information also exists on new technology introductions and market shares throughout the last 15 years. By applying secondary data and through conversations with manufacturers and experts in the field, the annual market shares of each technology and efficiency type were estimated. The result of this analysis was the net demand forecast, equal to the gross demand forecast minus the effects of naturally occurring conservation.

The effects of consumer response to rising real prices for water were captured through a simulation process. These impacts were not estimable through the econometric modeling process that was used to forecast gross demands, as few water districts increased their real water prices in the historical period. Simulated price increase scenarios through 2050 were designed to measure impacts of a range of possible future price alternatives. The most likely case assumed an average 0.25% annual increase in real water prices, which by the year 2050 represents an approximate 16% increase in the real price of water relative to 1992. The high case assumed a 0% increase while the low case assumed a 0.5% annual increase in real water prices. The result of this analysis was the price-net demand forecast, equal to the net demand forecast minus the effects of consumer response to simulated water price increases.

⁸For example, the National Energy Policy Act of 1992 requires that all showerheads and toilets manufactured in the U.S. be water-conserving fixtures.

Since the forecast model used a monthly time step, the monthly price-net forecasts were aggregated in different ways to estimate average demands for different portions of the year. For any provider, demand on an average day (“annual average demand”) is equal to the sum of water sales for all customer classes in the year divided by 365 days per year. Average peak-season demand is equal to the sum of forecasted sales for all customer classes for the months of June through September, divided by 122 days. Average non-peak season demand was calculated similarly for all sales between October and May, divided by 243 days.

PEAK DAY DEMAND FORECAST

Water demands are very weather-dependent. Demands increase markedly on hot, dry days. It is critical for the RWSP to be cognizant of the demands on the hottest and driest days, the so-called “peak-day” demands. Peak day demands were estimated by combining:

- Historically-based information on the relation of peak day demand to demand on an average day; with
- The forecast of average annual demand for each water district.

Historical comparisons of peak day demands with average annual demands are common for water planners; historically robust comparisons were collected from previous water demand studies conducted in the Portland area. These comparisons were measured as a ratio of demand on the peak day to demand on an average day. For example, a “peak day ratio” of 1.6 means that a water district with a 100 mgd annual average demand is expected to generate a 160 mgd peak day demand.

Estimates of peak day demands were further adjusted by two other factors, both of which tended to increase the peak day ratio.

The first upward adjustment to the peak day ratio focused on peaks that occurred under particularly adverse (i.e. hot and dry) weather conditions, rather than on more typical peak days. The econometric models used to estimate gross demand generated statistically reliable estimates of the relationship of sales per account to temperature and precipitation. Based on these relationships, a “95th percentile” peak-day demand was

estimated and used to adjust the peak day ratio.⁹

Second, naturally occurring conservation also has an effect on the peak day ratio. As naturally occurring conservation chiefly affects indoor end uses, the share of total demand represented by outdoor end uses is likely to grow over time. This implies that the ratio of the peak season to the annual average will also grow over time. As peak season demands become relatively larger, this will have an upward effect on the peak day ratio.

After the peak day ratio for each water district was estimated and adjusted as described, it was multiplied by gross average annual demands for that water district. The result of this calculation yielded the forecasted gross peak day demands. The forecasted net and price-net peak day demands were calculated by subtracting the effects of naturally occurring conservation and consumer response to simulated water prices from the gross peak day forecast.

DISCUSSION OF RESULTS

Figures V-1 through V-4 display the forecasts of annual average demand for the region and each of the three counties. Table V-2 compares the annual average forecasted demand for the year 2050 under high, medium, and low growth assumptions to the 1992 base, and indicates the average annual growth rates over the planning period.

⁹In other words, this demand was higher than the peak-day demand under 95% of the historical weather conditions.

Figure V-1

Water Demand for High, Baseline, and Low Growth Scenarios Portland Metropolitan Region 1992--2050 Annual Average: All Customer Classes

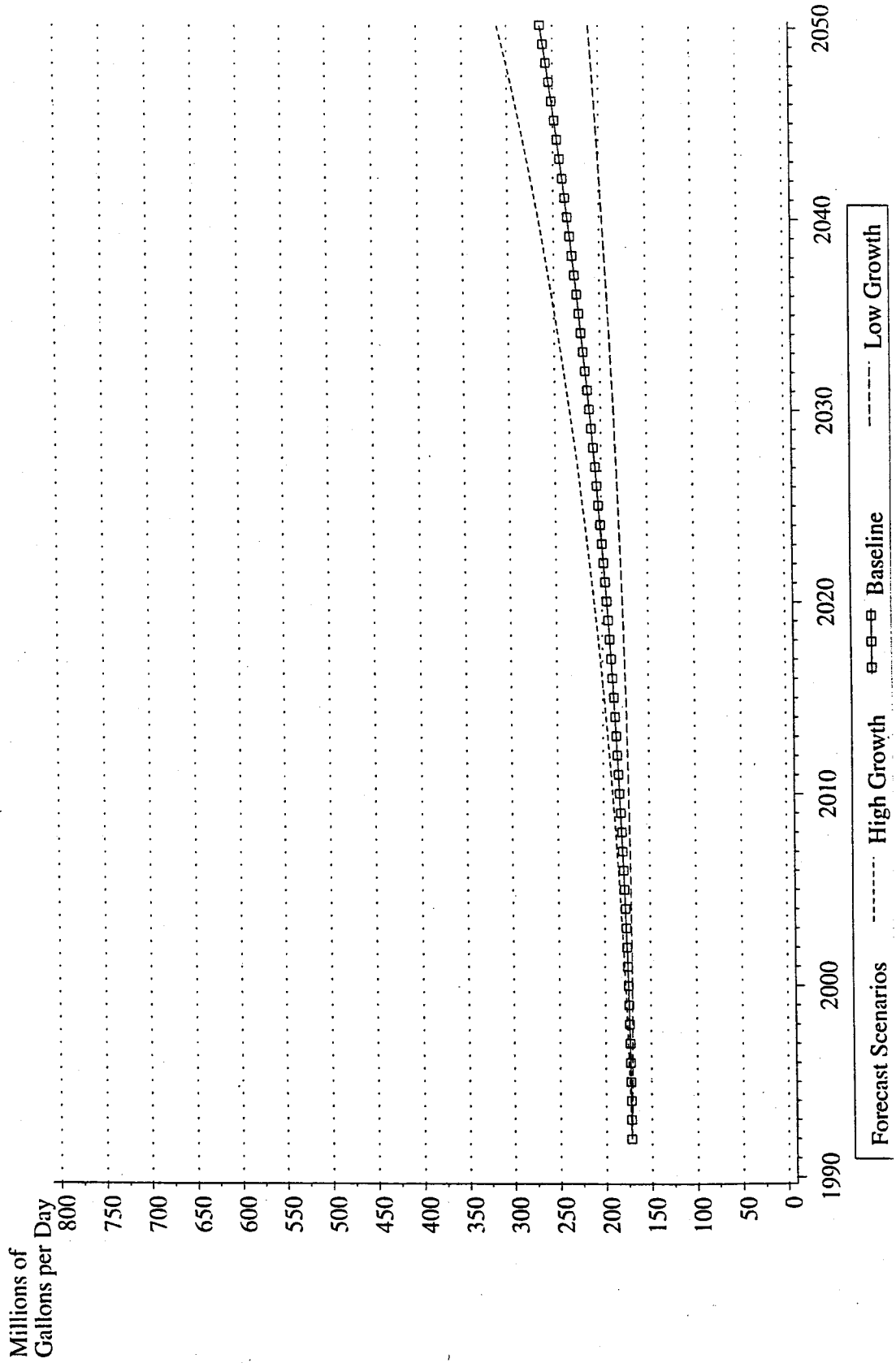

Figure V-2

Water Demand for High, Baseline, and Low Growth Scenarios Multnomah County 1992--2050 Annual Average: All Customer Classes

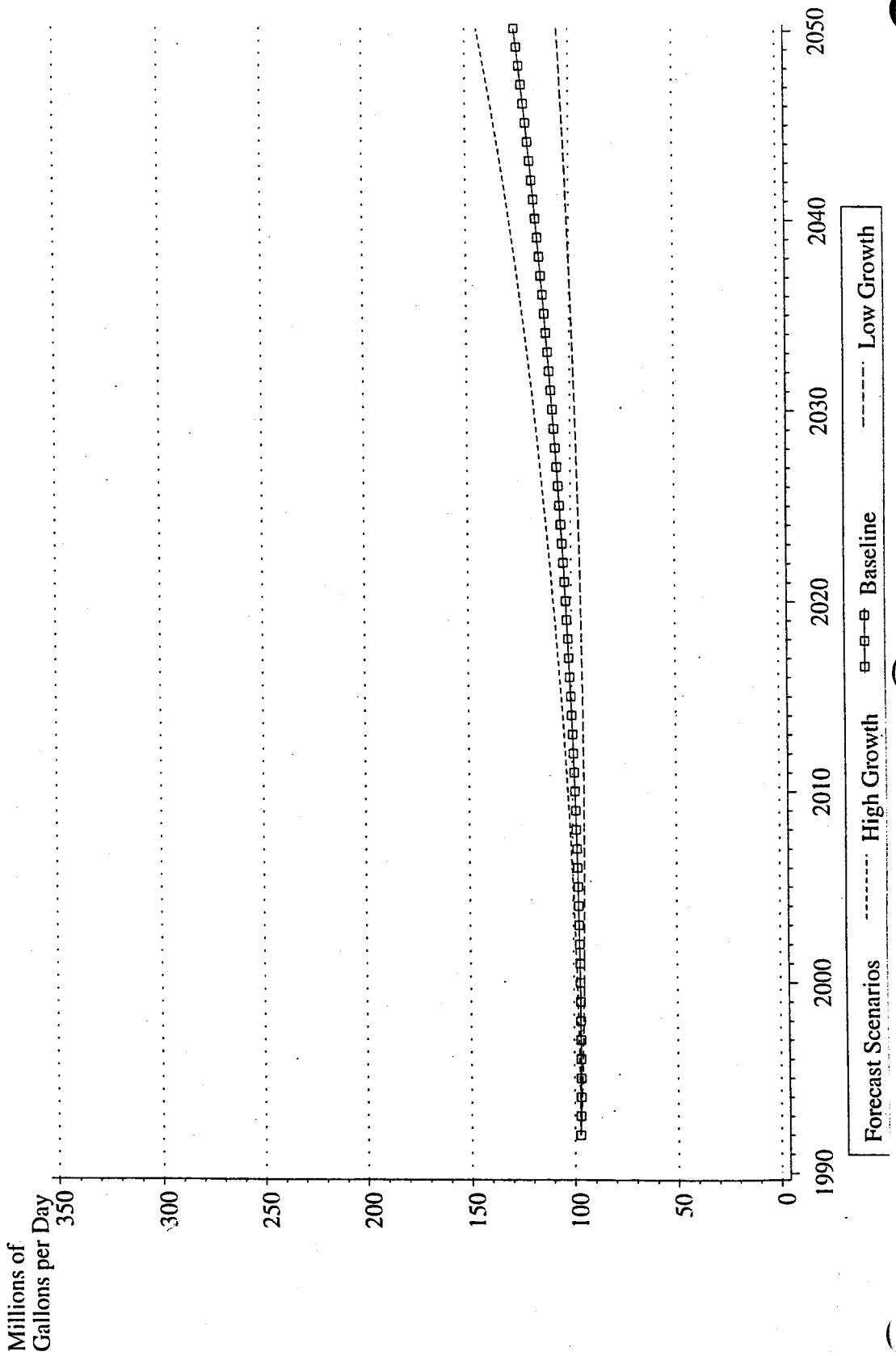

Figure V-3

Water Demand for High, Baseline, and Low Growth Scenarios Clackamas County 1992--2050 Annual Average: All Customer Classes

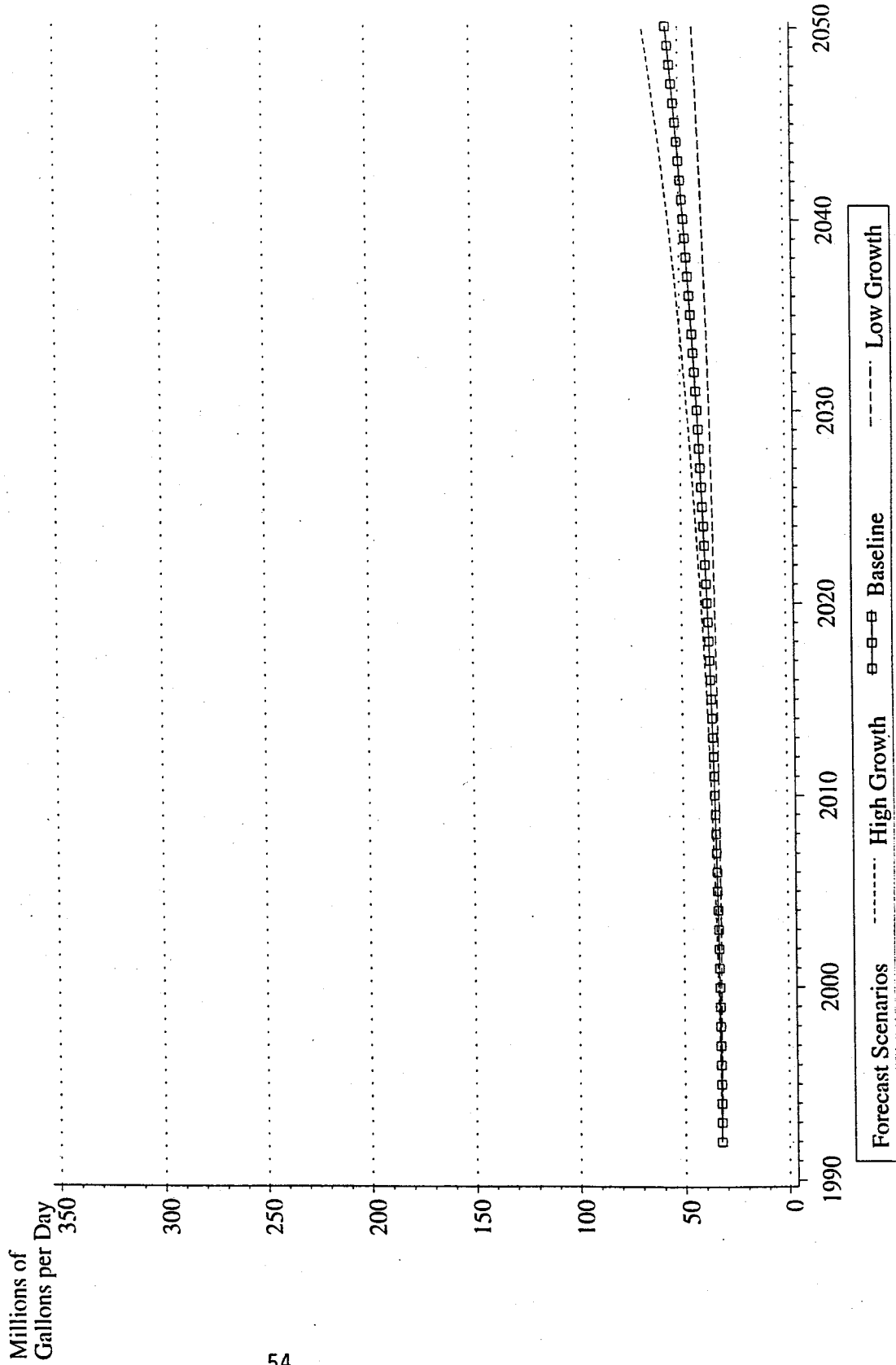

Figure V-4

Water Demand for High, Baseline, and Low Growth Scenarios Washington County 1992--2050 Annual Average: All Customer Classes

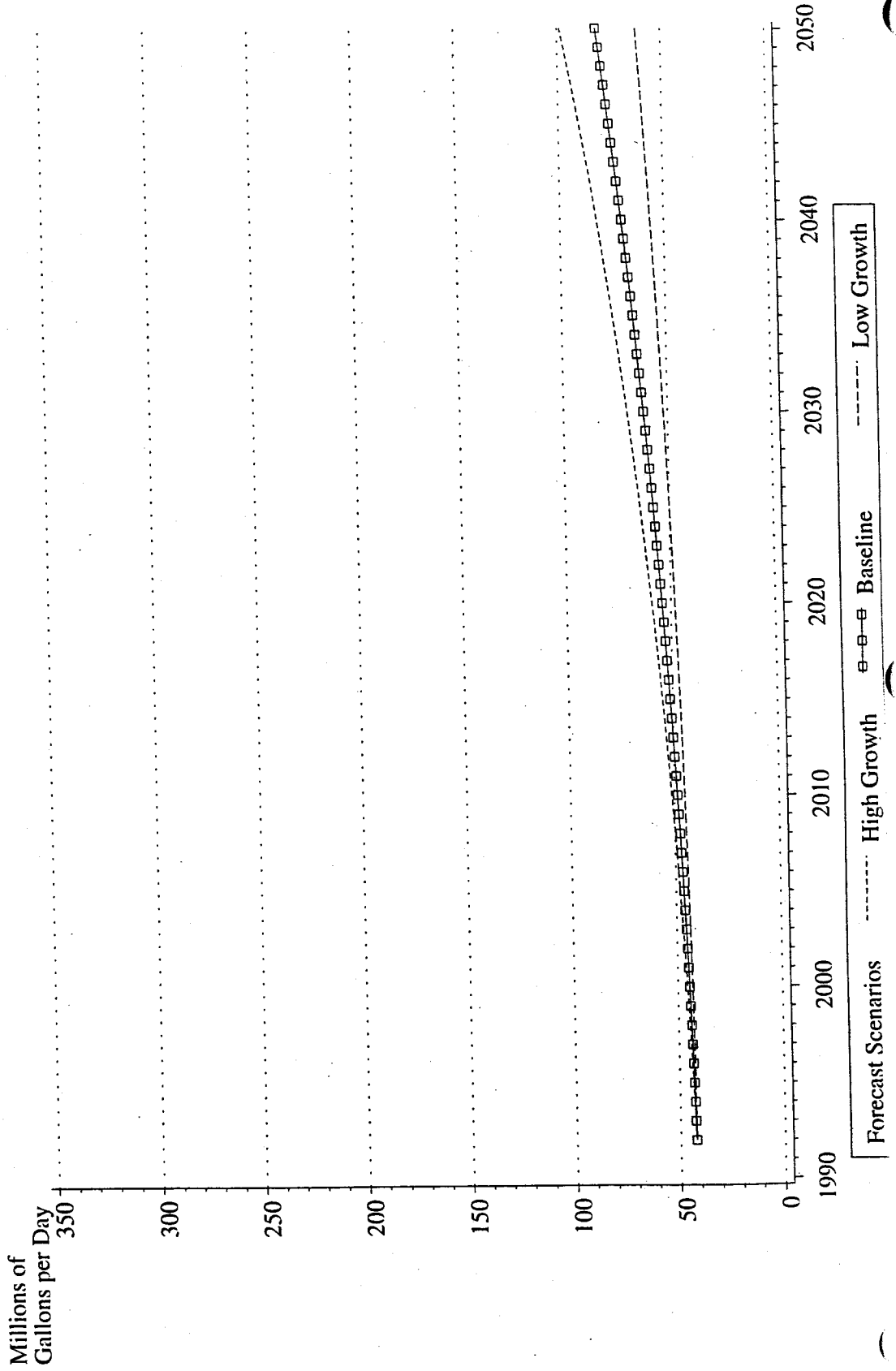

Table V-2
FORECASTED ANNUAL AVERAGE WATER DEMANDS (MGD) AND
AVERAGE ANNUAL GROWTH RATES

	1992	2050: High	2050: Medium	2050: Low
Region	172	310 (2.1%)	264 (1.5%)	211 (0.7%)
Multnomah County	97	144 (1.4%)	126 (0.9%)	106 (0.3%)
Clackamas County	33	67 (2.6%)	56 (1.9%)	43 (0.9%)
Washington County	42	99 (3.1%)	82 (2.4%)	62 (1.4%)

Figures V-5 through V-8 present the average peak season forecasts, and Table V-3 shows the 1992 and 2050 figures and annual growth rates.

Figure V-5

Water Demand for High, Baseline, and Low Growth Scenarios Portland Metropolitan Region 1992--2050 Peak Season: All Customer Classes

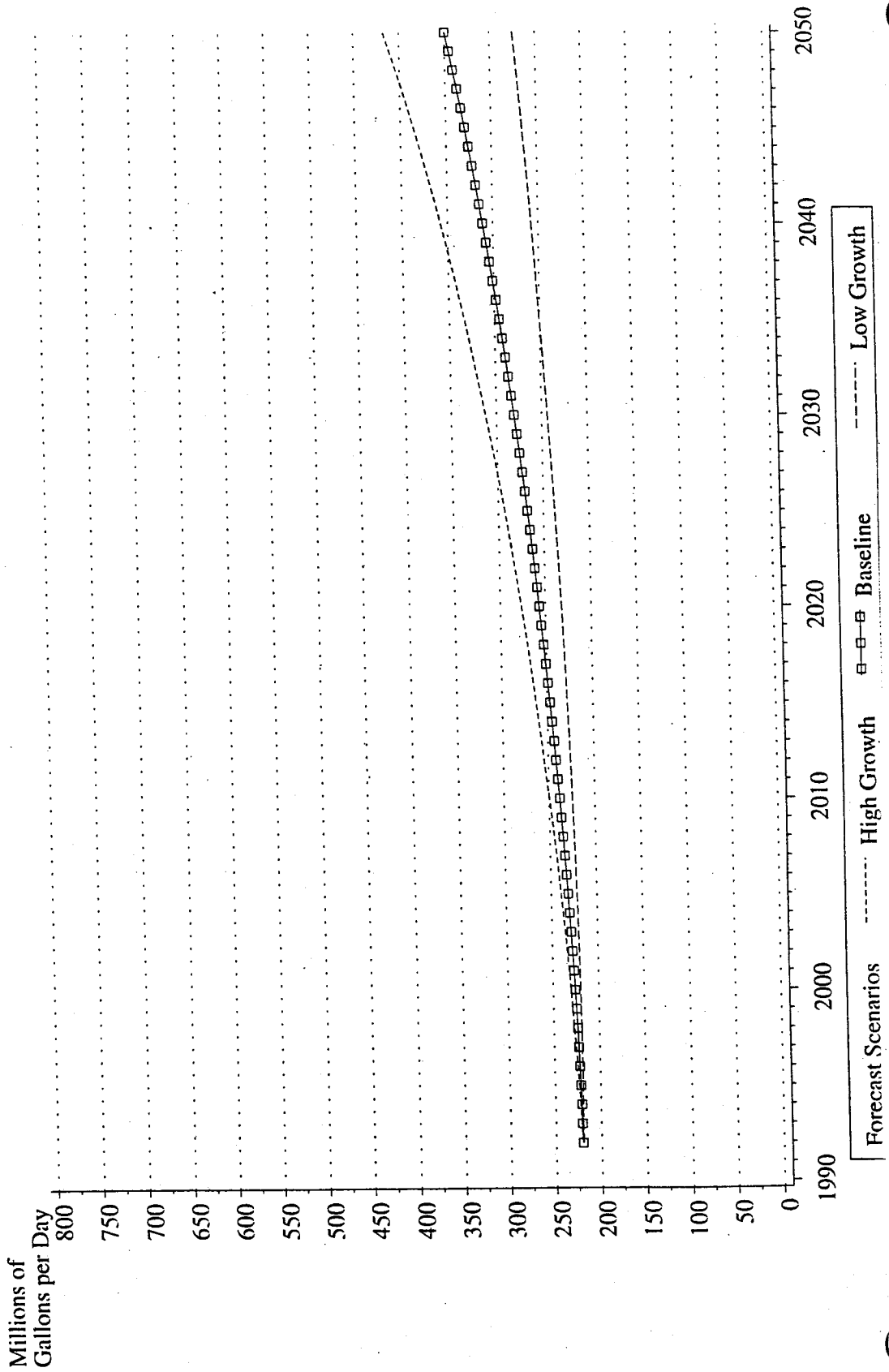

Figure V-6

Water Demand for High, Baseline, and Low Growth Scenarios Multnomah County 1992--2050 Peak Season: All Customer Classes

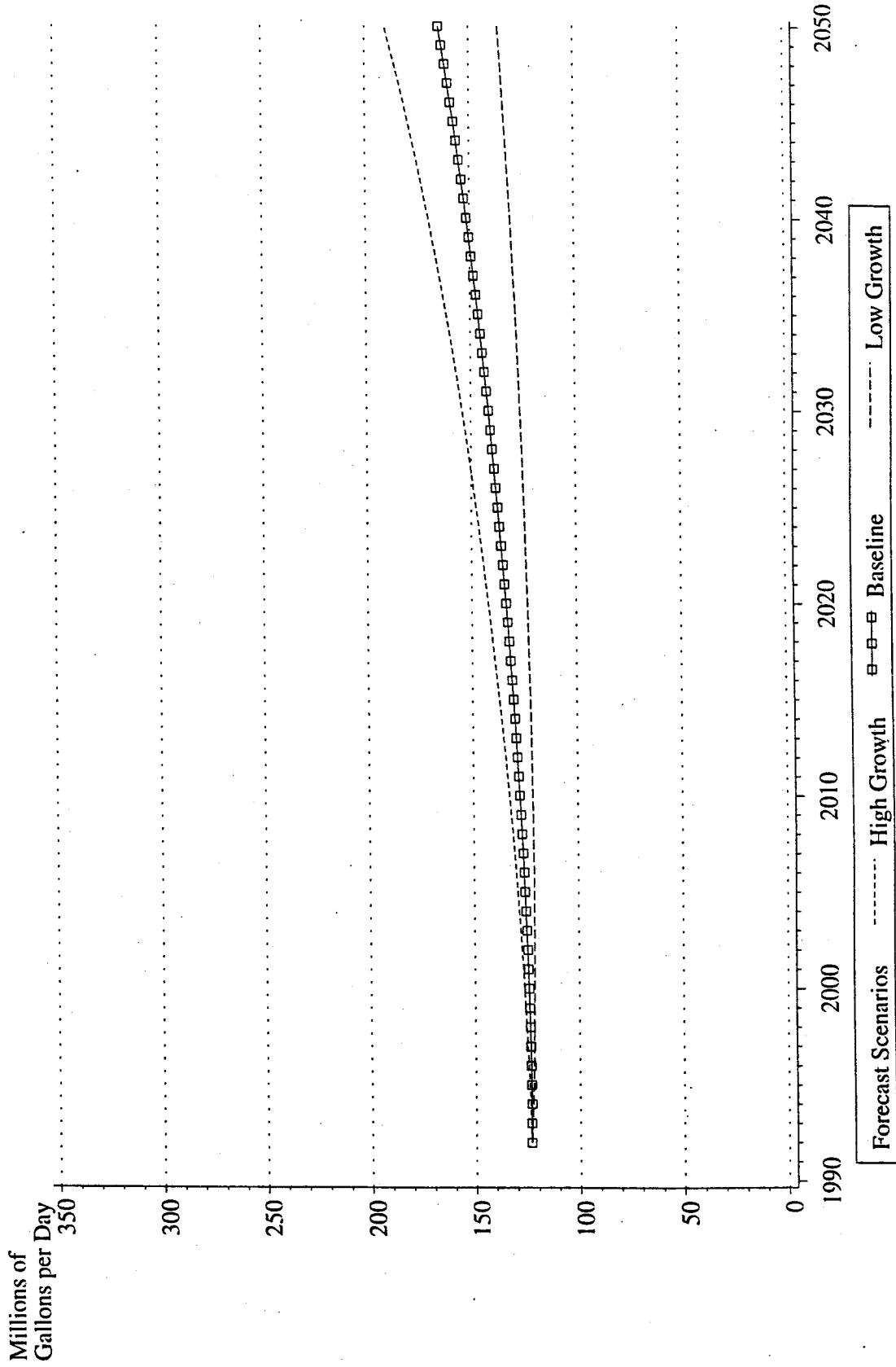

Figure V-7

Water Demand for High, Baseline, and Low Growth Scenarios Clackamas County

1992--2050 Peak Season: All Customer Classes

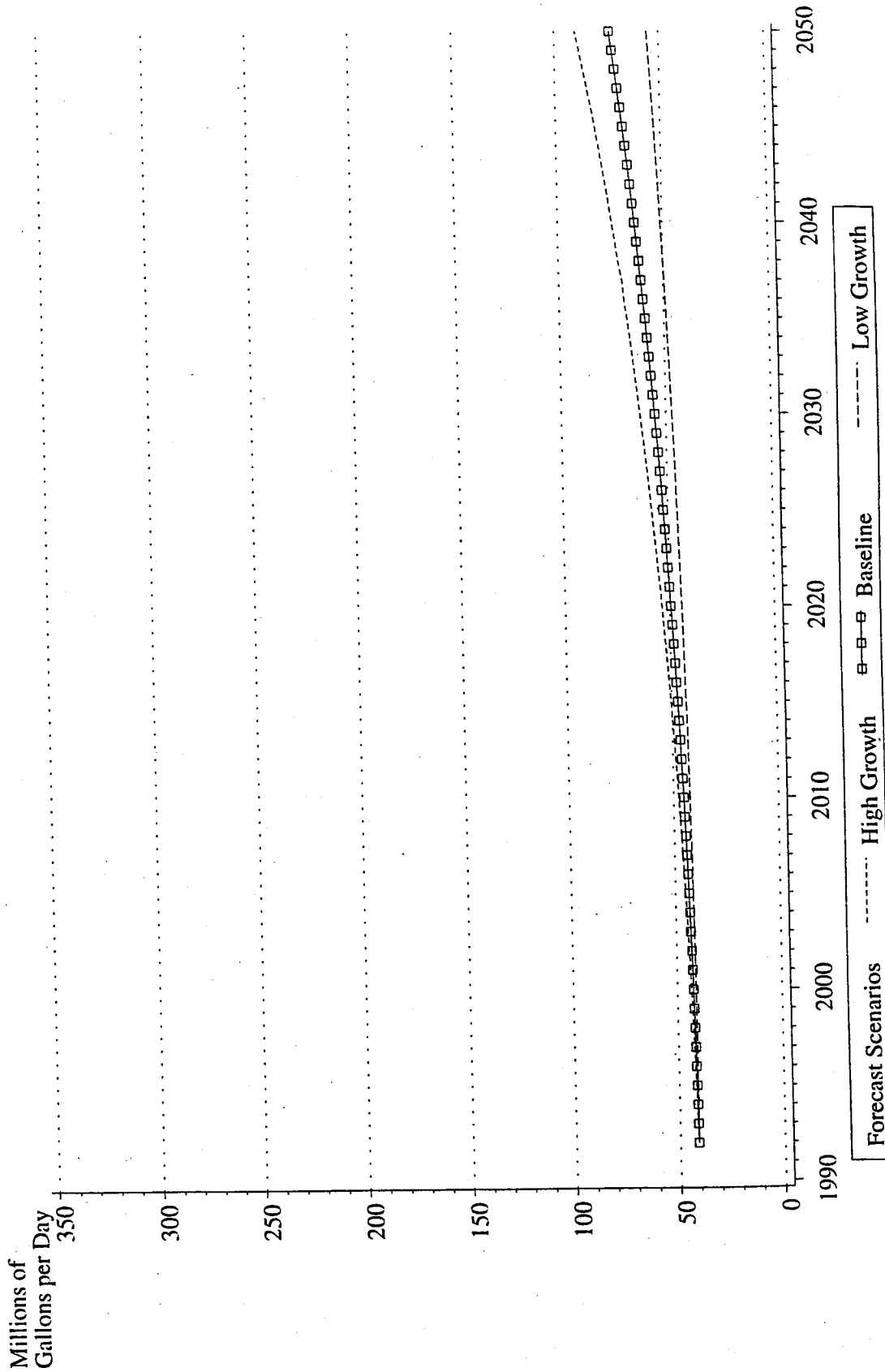

Figure V-8

Water Demand for High, Baseline, and Low Growth Scenarios Washington County 1992--2050 Peak Season: All Customer Classes

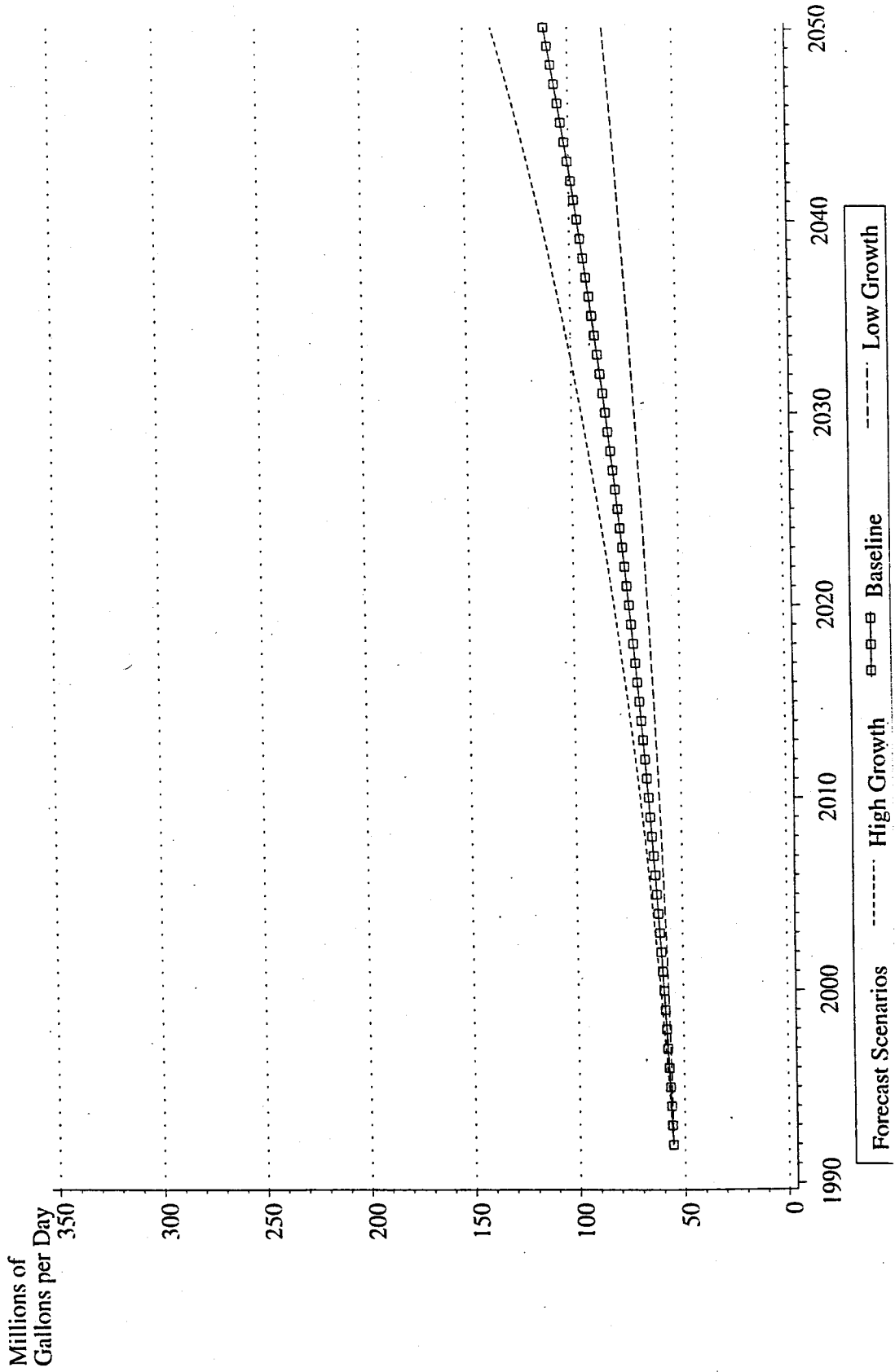

Table V-3
FORECASTED PEAK SEASON WATER DEMANDS (MGD) AND
AVERAGE ANNUAL GROWTH RATES

	1992	2050: High	2050: Medium	2050: Low
Region	220	417 (2.3%)	350 (1.7%)	275 (0.8%)
Multnomah County	123	190 (1.6%)	165 (1.1%)	136 (0.4%)
Clackamas County	41	90 (2.8%)	74 (2.1%)	56 (1.1%)
Washington County	56	137 (3.2%)	111 (2.5%)	84 (1.5%)

Finally, Figures V-9 through V-12 present the peak day demand forecasts. Table V-4 shows the corresponding 1992 and 2050 peak day demands and annual growth rates.

Figure V-9
Water Demand for High, Baseline, and Low Growth Scenarios
Portland Metropolitan Region
1992--2050 Peak Day: All Customer Classes

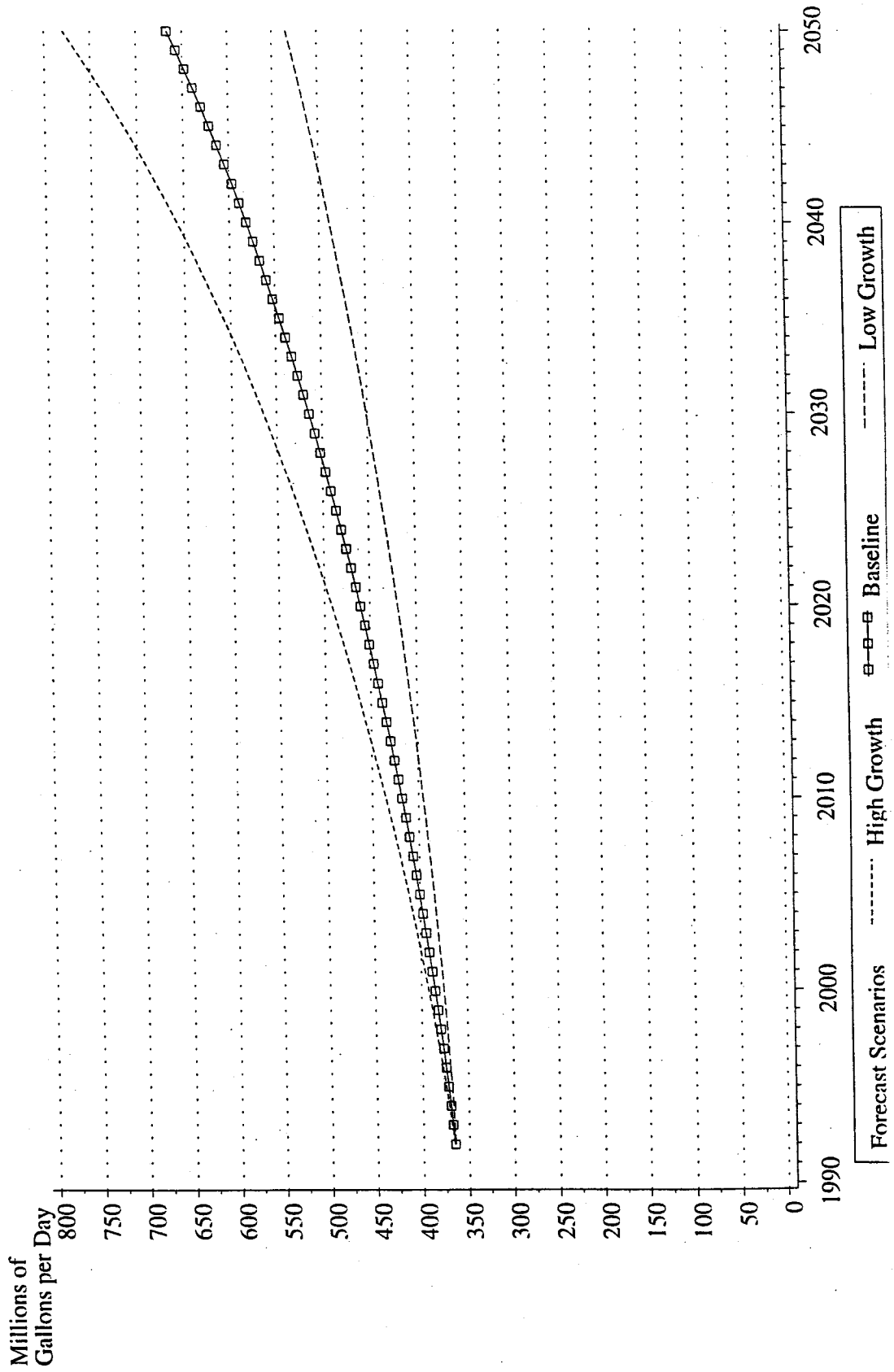

Figure V-10

Water Demand for High, Baseline, and Low Growth Scenarios Multnomah County 1992--2050 Peak Day: All Customer Classes

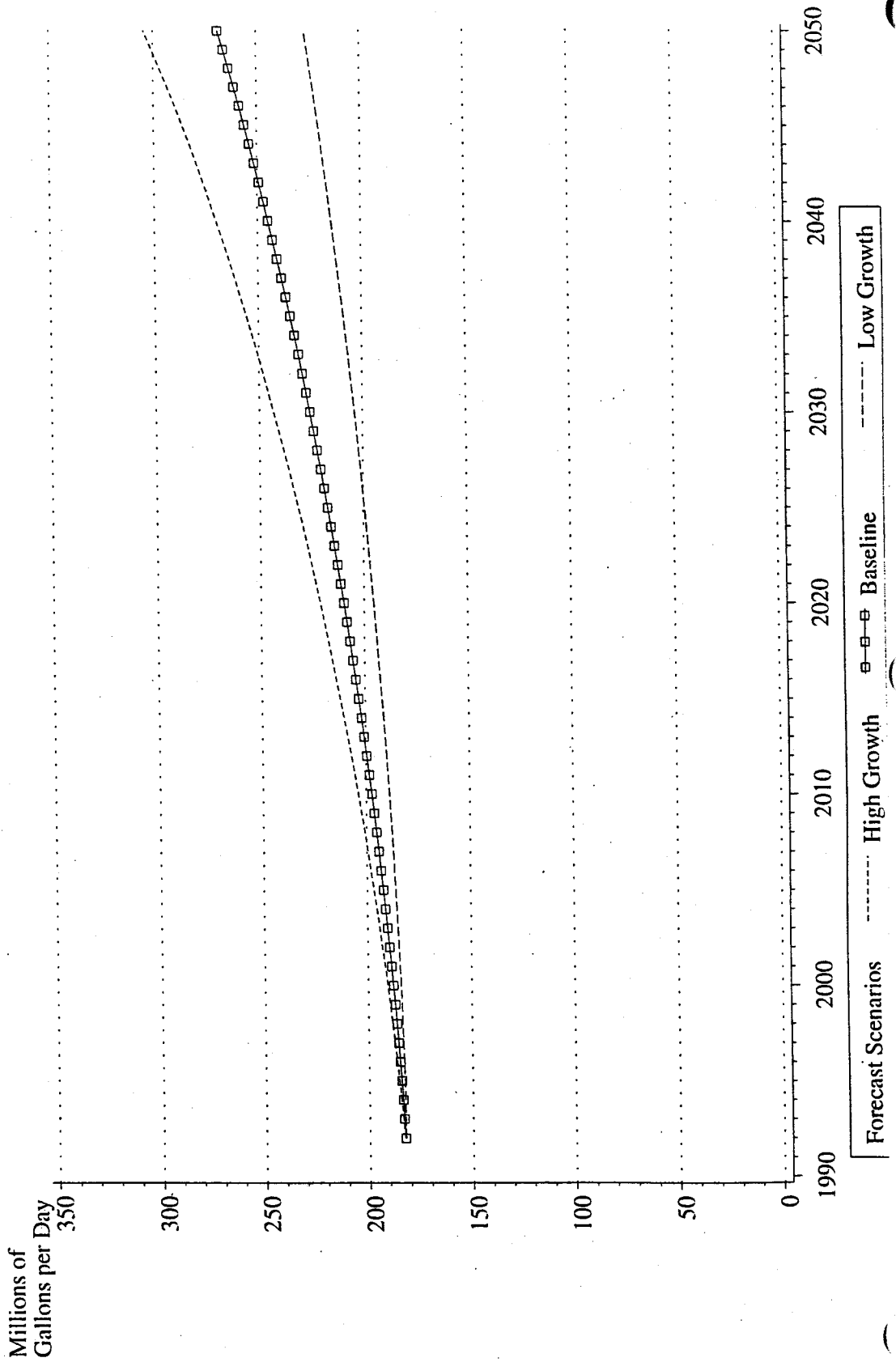

Figure V-11

Water Demand for High, Baseline, and Low Growth Scenarios Clackamas County 1992--2050 Peak Day: All Customer Classes

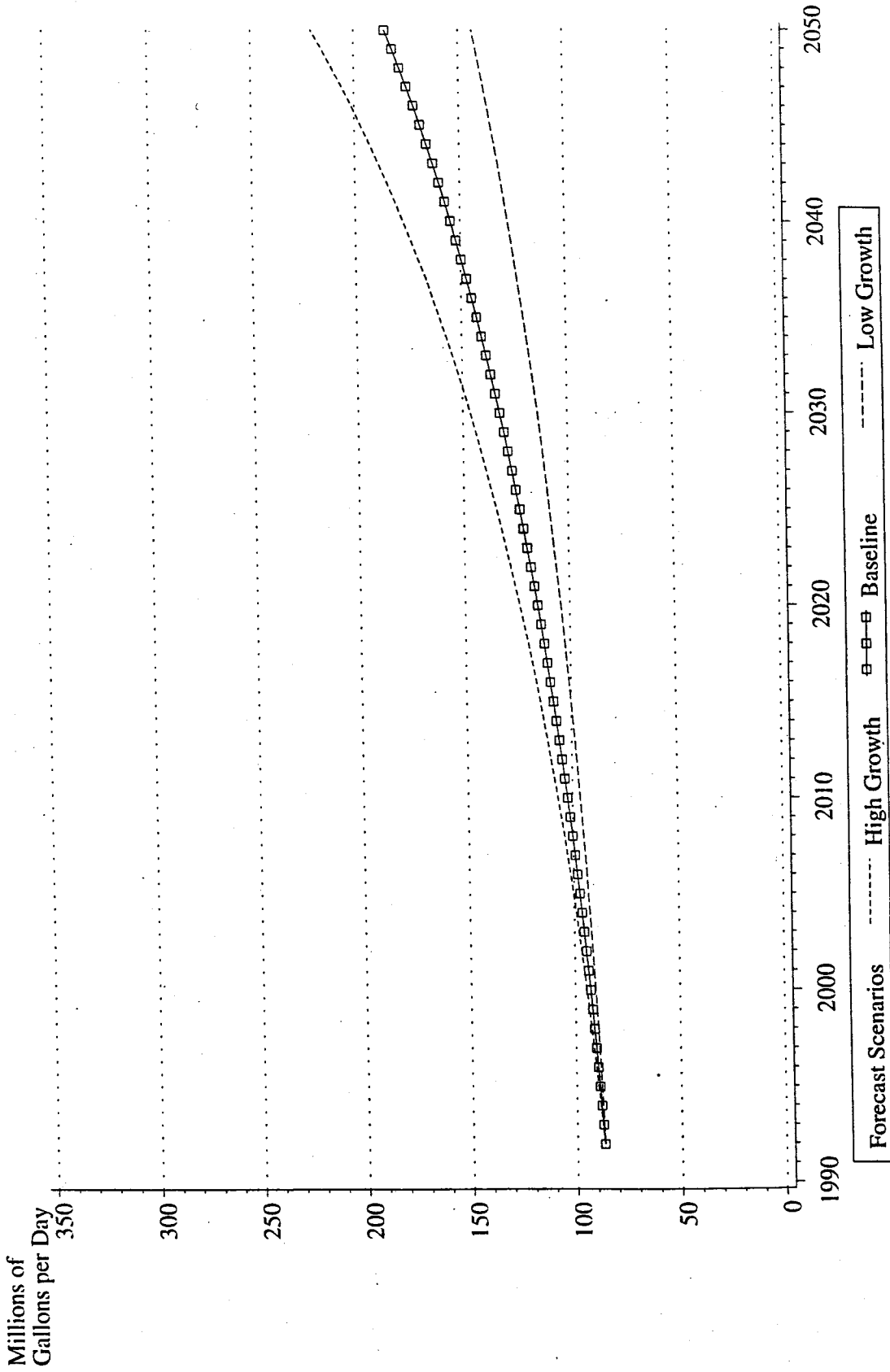

Figure V-12

Water Demand for High, Baseline, and Low Growth Scenarios Washington County 1992--2050 Peak Day: All Customer Classes

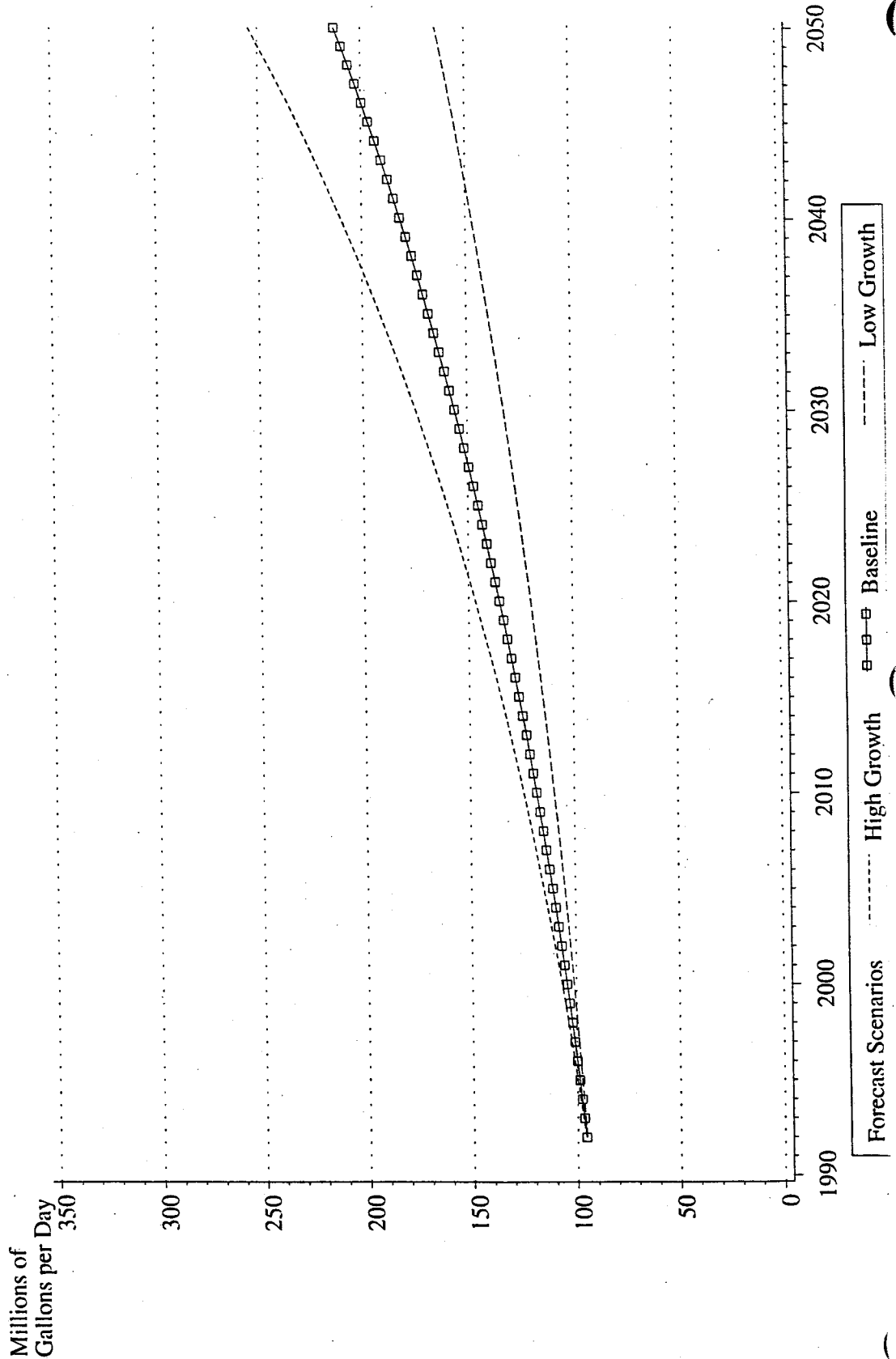

Table V-4
FORECASTED PEAK DAY WATER DEMANDS (MGD) AND
AVERAGE ANNUAL GROWTH RATES

	1992	2050: High	2050: Medium	2050: Low
Region	365	780 (2.7%)	667 (2.2%)	535 (1.4%)
Multnomah County	183	305 (1.8%)	269 (1.4%)	227 (0.8%)
Clackamas County	87	221 (3.4%)	185 (2.7%)	144 (1.8%)
Washington County	96	255 (3.6%)	213 (2.9%)	164 (1.9%)

In examining these results, several key points emerge:

- Demands in Clackamas and Washington county have a significantly higher peaking component than demands in Multnomah County. This can be attributed to the higher fraction of single-family residences in Clackamas and Washington counties and the larger lot sizes.
- Under the high forecast, regional peak day demand will more than double over the planning period. In Washington County, the increase in peak demand exceeds 165%.
- Demand growth in Clackamas and Washington counties is expected to be significantly higher than in Multnomah County. By the end of the planning period, demands, will be more evenly spread across the region rather than being significantly concentrated in Multnomah County as they are now. Given regional population and employment growth patterns, this is not surprising.
- The higher growth in the “peakier” demands explains why regional peak-day demand is expected to grow significantly faster than either annual or peak-season demand. This pattern is also due to the damping effect of naturally-occurring conservation on indoor demands previously discussed. In other words, *meeting peak day demands will become increasingly more critical to the region over time.*

FUTURE FORECAST UPDATES

As discussed in detail in Chapter XI, a basic premise of the RWSP is the provision of sufficient flexibility to respond to uncertainty in forecasted demands. Since population, employment, and the relationships of these variables to water demands are inherently difficult to forecast, particularly over a long planning period, it is incumbent on the region's providers to frequently update the demand forecasting results and modify the resource strategies as necessary.

An example illustrating this need to reassess demands is the current infusion of so-called "high-tech" firms in the region. The manufacturing processes of these firms are very water intensive. This may increase demands in the short term to a level above the high case forecast. Along with these abrupt changes comes the potential for significant water recycling and reuse that can temper the demand increases. While it is critical to keep abreast of these and other influences changing the demand outlook, the discussion in Chapter XI will show that the region is in the fortunate position of having resources in the short-to-medium term that are sufficient to meet demands even substantially higher than the high case forecast.

In general, it is recommended that demand forecasts be updated at least every five years. More frequent updates will be necessary in the event of specific known changes that may affect near-term actions by the regional providers.

VI. EXISTING AND COMMITTED RESOURCES: THE BASE CASE

VI. EXISTING AND COMMITTED RESOURCES: THE BASE CASE

The Portland metropolitan region contains an intricate web of water supply systems. This web, evolving over the last century, is comprised of surface water storage, groundwater, water treatment plants, several run-of-river intakes, and a host of pipelines, pumps, and tanks to convey the water.

The existing supply sources function on regional, subregional, and local levels. A few agencies supply the water, while many others purchase the water wholesale and distribute it to retail customers via local systems.

Existing water systems in the region have an estimated usable storage capacity of 11.4 billion gallons and a delivery capacity of 413.8 million gallons per day (mgd). Current regional peak-day demand, even under weather conditions that approach the hottest and driest that the region has experienced over a 65-year historical period of record, is about 370 mgd. Despite this apparent excess capacity, some individual providers within the region do face more immediate shortfalls due to transmission constraints.

In addition to maintaining existing water supply sources and transmission facilities, the region's water providers are committed to completing several facility additions, expansions and improvements over the next two to ten years. The projects will provide nearly 80 mgd of incremental delivery capacity and 5.2 billion gallons of additional storage. These additions are not being evaluated as part of the Regional Water Supply Plan. Rather, the project participants assume these committed resources will be completed, and include them in the project's baseline resource assumptions or "base case".

Table VI-1 summarizes the region's existing and committed resources. The remainder of this chapter describes them.

**Table VI-1
REGIONAL WATER SUPPLY PLAN
EXISTING AND COMMITTED SUPPLY SOURCES**

Source	Existing		Additional Committed		Existing and Committed	
	Delivery Capacity (mgd)	Usable Storage Capacity (mg)	Delivery Capacity (mgd)	Usable Storage Capacity (mg)	Delivery Capacity (mgd)	Usable Storage Capacity (mg)
Bull Run Res 1,2	210	10,200			210	10,200
Clackamas	66		22.5		88.5	
Trask/Tualatin	43.5	1,153	20	5,214	63.5	6,367
Southshore Wellfield	35		37		72	
Local Sources						
South	28.4				28.4	
West	12.8				12.8	
East	18.1				18.1	
Subtotal	59.3				59.3	
Total	413.8	11,353	79.5	5,214	493.3	16,567

EXISTING WATER SUPPLY SOURCES AND FACILITIES

Bull Run River

The Bull Run River has been the primary source of drinking water for the City of Portland for 100 years. Many other water providers in the region have purchased Bull Run water wholesale for decades. The Bull Run Watershed, located about 35 miles east of Portland in the upper Sandy River Basin, includes approximately 179 square miles. Most of the watershed lies within the Bull Run Watershed Management Unit (BRWMU), an area of 150 square miles. The BRWMU is closed to the general public to maintain its high water quality.

In 1909, the Oregon Legislature granted Portland the exclusive right to use the waters of the Bull Run River for municipal purposes. Today, the 800,000 residents served by the City of Portland and its 19 wholesale customers use about 25% of the Bull Run watershed's total water yield (about 37 billion gallons per year). The City of Portland has expanded and can continue to expand the municipal use of Bull Run water without obtaining additional water rights.

Though the Bull Run River was the original water supply source for Portland, Bull Run Lake, located at the headwaters of the watershed, was the first source of water used to supplement river flows during the summer season. Today, Bull Run Lake is used only in very hot, dry years. The City of Portland constructed one reservoir in the watershed during the 1920's and another in the 1960's. The reservoirs remain full during much of the year. In warm summer months, they are drawn down to meet higher peak-season demands. The system relies on fall, winter, and spring rains (rather than winter snowpack) to ensure the reservoirs are full at the beginning of the summer drawdown season.

Unlike most water suppliers in the United States, the City of Portland is not required to filter Bull Run water because the raw water quality is so high. Over time, reservoirs collect sediment from natural processes. As a result, of the 16.5 billion gallons (50,000 acre-feet) stored in the two reservoirs, only about 10.2 billion gallons (about 31,000 acre-feet) is usable. As summer ends and fall rains begin, the reservoirs usually refill quickly, and the cycle repeats. Even under the most adverse historical flow conditions, both reservoirs are full at the start of the summer drawdown.

Bull Run water is disinfected at the system Headworks (where intakes are located). The water is then fed by gravity from the Bull Run Watershed to the Portland metropolitan region via several large conduits and a 50 million gallon underground reservoir at

Powell Butte (southwest of Gresham). The current delivery capacity of the Bull Run system is 210 mgd.

No specific instream flow requirements have been set for the Bull Run River, although preserving flows to maintain the health of aquatic systems is part of President Clinton's recently established Northwest Forest Plan. The Bull Run River is located upstream from a portion of the Sandy River that is a designated State Scenic Waterway and Federal Wild and Scenic River. The Oregon Water Resources Commission has established flow levels (or "Diack" flows) necessary to meet the objectives of the State Scenic Waterway authorizing legislation.

Clackamas River

The Clackamas River lies in Clackamas and Marion Counties on the western slope of the Cascades. The river flows in a general northwesterly direction for about 83 miles from its headwaters to its confluence with the Willamette River. The basin is a mix of public and private ownership and diverse land uses. Much of the river is a designated State Scenic Waterway (above river mile 8 at Carver Bridge). An instream water right of 400 to 640 cubic feet per second has been established for the Clackamas River at the mouth.

The Clackamas River currently provides municipal water to about 175,000 residents within the RWSP study area. Participating providers on the Clackamas, including the City of Lake Oswego, Clackamas River Water (formerly the Clackamas Water District and Clairmont Water District), and the South Fork Water Board (serving the cities of Oregon City and West Linn), have developed 66 million gallons per day (mgd) of intake and treatment capacity on the lower five miles of the river. Upstream, water from the Clackamas River supplies the City of Estacada. In addition, several Portland General Electric facilities are operated on the river for hydropower production.

Trask/Tualatin System

The Trask River/Tualatin River water system supplies water to over 120,000 residents, and many businesses and institutional customers in the western part of the region. This system provides 43.5 mgd of delivery capacity, and serves customers in the cities of Hillsboro, Beaverton, and Forest Grove, and in the Tualatin Valley Water District. This system also serves the unincorporated communities of Cherry Grove, Gaston, Dilley, Cove Orchard, Cornelius, and the Laurelwood Academy Water Cooperative.

Source water is obtained from the Trask and Tualatin Rivers. Water is diverted and treated to meet drinking water standards in two locations. One, owned by the City of Hillsboro, is a small, slow sand filter plant (3.5 mgd) near the community of Cherry Grove. The other, located just south of Forest Grove, is owned by the Joint Water Commission (JWC), which includes the cities of Hillsboro, Forest Grove, and Beaverton, and the Tualatin Valley Water District and is a 40 mgd capacity full-treatment plant.

Trask River water is stored in the 1.3 billion gallon (4,000 acre-feet) Barney Reservoir and is diverted to the Tualatin via a conduit through the North Coast/Willamette Basin divide. In addition, in most years, the JWC has access to 4.2 billion gallons from Hagg Lake, which is owned by the Bureau of Reclamation and located on Scoggins Creek.

Columbia South Shore Wellfield

In the early 1970s, the City of Portland developed plans for a groundwater wellfield as an emergency backup and peaking supply source. During the mid-1980s, the City of Portland constructed 22 wells totaling about 90 mgd in capacity in the Columbia South Shore area east of the Portland International Airport. Of the 22 wells, 6 are located in the City of Gresham and Blue Lake Park. The wells pump water from a variety of geologic formations, including the Blue Lake, Troutdale Gravel, Troutdale Sand and Gravel, and Columbia River Sands aquifers.

Since this construction, the City of Portland has used the wells about five times to augment summer water supply from Bull Run watershed reservoirs. Groundwater is pumped to Powell Butte, where it is blended with Bull Run water and distributed throughout the Portland service area (a small percentage of Portland customers receive 100% groundwater during the periods when the wellfield is being used).

In 1986, groundwater contamination was discovered near the wellfield. Since then, the City of Portland's ability to use the wellfield has been limited to prevent migration of contamination plumes. As a result, the current usable delivery capacity of the wellfield is assumed to be 35 mgd. The City is working closely with the Oregon Department of Environmental Quality and with the responsible parties to implement a remediation program that restores the wells to their full capacity.

EXISTING LOCAL WATER SUPPLY SOURCES AND FACILITIES

A number of smaller communities in the region use local water supplies for base use or peaking purposes. Small sources provide nearly 60 mgd of capacity to the region (see Table VI-2). These sources consist primarily of groundwater wells, but also include small water treatment plants on the Tualatin and Molalla rivers. Based on a telephone survey of the relevant providers, the Regional Water Supply Plan assumes that these sources will be available throughout the planning period.

TRANSMISSION AND STORAGE

The region's water systems include a myriad of transmission lines, terminal and distribution storage facilities, major pumping and pressure reducing stations, and system inerties.

Transmission lines running north-south and east-west range from 4-inch diameter pipes in small districts to the 66-inch diameter Bull Run Conduit No. 4. The 60-inch Washington County Supply Line carries water from Powell Butte to Beaverton. Many miles of 12-inch, 16-inch, and 24-inch pipes traverse the region, carrying water to the more than 1 million residents.

Each project participant maintains storage reservoirs to provide backup supply and fire flows. Across the region, transmission and distribution storage facilities hold nearly 600 million gallons of water.

ADDITIONAL COMMITTED RESOURCES

As alluded to earlier, there are several projects to which regional providers have committed which will significantly enhance the availability of supplies in the region.

Barney Reservoir Expansion

The Joint Water Commission and the Tualatin Valley Water District are expanding the existing Barney Reservoir on the Trask River. The project involves raising the 72-foot, earth-fill Dam by 50 feet to increase the water storage capacity of Barney Reservoir from 1.3 billion gallons (4,000 acre-feet) to 6.5 billion gallons (20,000 acre-feet) (a 450 acre pool). This project has received all necessary permits and is in the design

phase. The Barney expansion project is expected to be completed by 1998. In addition, improvements to the JWC intake and treatment plant are expected to increase its delivery capacity by 20 mgd to 63.5 mgd by 1997.

**Table VI-2
SMALLER MUNICIPAL SUPPLY SOURCES UTILIZED IN THE REGION**

Provider	Available Capacity (mgd)	Source Type*
Multnomah County		
Fairview	2.7	G
Interlachen	1.3	G
Powell Valley	1.8	G
Troutdale	6.4	G
Wood Village	1.4	G
Portland	4.5	G
Total	18.1 mgd	
Washington County		
Forest Grove	1.3	S
North Plains	1.1	G
Sherwood	2.8	G
Tigard	1.1	G
TVWD	3.0	G
Cornelius/Gaston/Hill	3.5	S
Total	12.8 mgd	
Clackamas County		
Sandy	2.5	S
Canby	6.0	S,G
Boring	1.0	G
Damascus	3.3	G
Lake Oswego	0.3	G
Milwaukie	6.7	G
River Grove	1.3	G
Wilsonville	6.0	G
Skylands/G. Morie	0.3	G
Estacada	1.0	S
Total	28.4 mgd	
Grand Total	59.3 mgd	

* S = Surface water source
G = Groundwater source

Clackamas River

In addition to the 66 mgd of already-developed capacity, the Clackamas providers have committed to developing 22.5 mgd of additional capacity. This brings the total “base case” capacity on the Clackamas to 88.5 mgd. When this is compared to the 171 mgd (265 cubic feet per second) of water rights held by RWSP participants, there remains about 83 mgd of unused rights that could be developed to meet future demand growth.

Columbia South Shore Wellfield

As mentioned previously, the Columbia South Shore wells cannot routinely be operated at full capacity (90 mgd) due to nearby groundwater contamination plumes. The RWSP assumes that the current 35 mgd of wellfield capacity will ramp up to 72 mgd by 2005 and remain at that level through 2050. This is a reasonable, conservative assumption that accounts for potential remediation uncertainties and ongoing mechanical challenges associated with large, complex groundwater facilities.

VII. ANALYSIS OF WATER SUPPLY SOURCE OPTIONS

VII. ANALYSIS OF WATER SUPPLY SOURCE OPTIONS

The Regional Water Supply Plan included extensive analyses of each source option. These analyses formed the base to rate each option against the evaluation criteria. This chapter summarizes the results of those analyses. Readers who require greater detail should refer to the appropriate interim report or technical memorandum referenced in Appendix A.

COMPONENTS OF THE SOURCE OPTION ANALYSIS

For each of the five source options, the following issues were analyzed:

- **Water Availability.** This included the consideration of hydrology, water rights, and storage operations. The hydrologic data for each of the sources were based on a 1928-1992 period of record.¹⁰ In the discussion of each of the source options that follow, water availability is described with reference to monthly yield exceedance probabilities. The purpose is to determine the likelihood of obtaining various quantities of water from the source. However, actual system simulations in the *IRPlanner* model are based on daily streamflow records over the 65-year period of record (see discussion in Chapter X).
- **Environmental Impacts.** These include impacts to the natural and human environments. An extensive planning-level analysis of ten environmental factors was performed for each source option. Based on this analysis, each source was rated against each factor on a scale that ranged from 1 (no or minimal impact) to 5 (very serious impact).¹¹ These ratings were aggregated into composite ratings for the natural and human environments.¹² Table VII-1 shows the environmental factors included in these two categories.

¹⁰If the full 65-years of data were unavailable for some sources, the data were synthesized based on existing information.

¹¹In a few cases, a rating of 0 was given, indicating an actual enhancement to the particular environmental factor.

¹²The manner in which individual ratings were combined recognized the significant potential for adverse ratings on individual dimensions to kill a project. Therefore, the combination formula used gave disproportionate weight to high (adverse) scores. See Appendix B.

Table VII-1
COMPONENTS OF NATURAL AND HUMAN ENVIRONMENTS

Natural Environment	Human Environment
Fish Geotechnical and Natural Hazards Threatened & Endangered Species Wetlands Wildlife and Habitat	Cultural Resources Hazardous Materials Land Use Recreational Resources Scenic Resources

- **Raw Water Quality.** For each source, physical, inorganic, organic, and microbiological constituents, as well as dissolved oxygen and nutrients, were reviewed. Aesthetic aspects (taste, odor, hardness) of water was also assessed. In addition, an assessment was made of the ability to protect the upstream watershed and the resulting vulnerability of future raw water quality.
- **Vulnerability to Catastrophic Events.** The vulnerability of each source to volcanic, fire, slide, and spill events was assessed.
- **Ease of Implementation.** The ability to develop each source is largely a function of anticipated future legal or permitting difficulties. Permitting issues and requirements were identified and a judgmental assessment was made for each source option.
- **Treatment Requirements.** Based on the analysis of raw water quality, a treatment regime was developed and recommended for each source option. Because of concerns regarding risks of long-term or episodic water quality problems, the recommended treatment approaches provide multiple barriers of treatment which will result in water that exceeds current drinking water standards.

The recommended treatment will also provide protection from potential organic contaminant spills and provide for the removal and/or treatment of as-yet unidentified organic constituents, some of which might be subject to future regulation. Hence, it was assumed that any new regional water treatment plant would be provided with state-of-the-art

treatment (including GAC filters and, in some instances, ozone disinfection) designed to produce excellent treated water quality.

A key conclusion is that *all of the surface sources can readily be treated to meet or surpass all safe drinking water standards.*

- **Capital and Operating Costs.** Costs were estimated in 1994 dollars for all source-related facilities, including:
 - Intakes
 - Raw water pipelines
 - Treatment plants
 - Pumping stations
 - Finished water pipelines
 - Terminal reservoirs

The evaluation criteria associated with four of these issues (environment, raw water quality, catastrophic events, and ease of implementation) are expressed as simple rating scales. These evaluation ratings for each source option are presented in Table VII-2. Appendix B describes the computation of these ratings.

FLAVOR PROFILE ANALYSIS

In July 1995, the Portland Water Bureau analyzed the taste and odor of treated water from the Bull Run, Clackamas, and Trask/Tualatin systems, using treated samples available from potable water system facilities of regional providers. Samples from the Columbia and Willamette Rivers were also analyzed. These were taken from the drinking water systems of the cities of Kennewick, Washington, and Corvallis, Oregon respectively. Each potable water sample complied with all state and federal drinking water standards. In several cases, the water samples from different intake locations had been treated using methods different from those recommended in the Regional Water Supply Plan (see below).

This analysis was performed by a trained four-member Flavor Profile Panel, and was conducted using a structured, non-biased industry-accepted analytical technique. As shown in Appendix D, the analysis results indicated some differences in taste and odor among the samples. However, the intensities of the observed characteristics were at or near the method's detection limit. In this scale's range of intensity, it was expected that considerable variations in taste and odor descriptors would be identified by individual panel members. This was observed in the panel results.

The analysis indicated that the samples were fairly similar and acceptable in terms of taste and odor. The method of treatment has a great deal to do with drinking water's taste and odor before it is distributed to customers. The disposition of water within the distribution system can then further change taste and odors.

**Table VII-2
RATINGS OF SOURCE OPTIONS**

Source Option	Natural Environment	Human Environment	Raw Water Quality	Water Aesthetics	Watershed Protection	Vulnerability to Catastrophic Events	Ease of Implementation
Bull Run Dam 3	4.9	3.6	1.2	1.0	1.0	3.5	4.5
Columbia	2.6	2.5	2.1	2.5	5.0	3.3	3.5
Willamette	1.0	2.5	2.2	2.0	4.0	2.5	2.5
Clackamas (> 50 mgd)	2.4	1.0	1.8	2.0	2.0	2.5	2.0
Clackamas (≤ 50 mgd)	1.0	1.0	1.8	2.0	2.0	2.5	2.0
ASR	1.5	2.2	3.0	3.0	N/A	2.0	3.0

Note: Ratings range from 1 to 5; lower scores are preferred.

RESULTS OF SOURCE OPTION ANALYSES

Representative Sites

Each source option has associated facilities (intakes, treatment plants, dams, pipelines, etc.) that must be sited. The RWSP did not include detailed siting analyses for each of these facilities. Instead, based on the preliminary analyses performed, "representative sites" were identified. A "representative site" is defined as:

A potential intake, pipeline, water treatment plant, or other supply source-related facility location that merits detailed analysis because it offers the highest likelihood of successful permitting and potential development based on preliminary analyses of technical, land use, water quality, environmental, cost, and other relevant factors.

Note that each representative site would require more detailed study if the corresponding source option is pursued. This could ultimately result in selection of a different site.

A source-by-source discussion of the analytical results for each source follows.

Bull Run Dam 3

Description of Option

Major components of this project would include the dam and reservoir, new access road(s) to the facility, headworks outlet improvements, a conduit from the headworks to the Powell Butte Reservoir, and new storage at Powell Butte. Temporary staging areas and a diversion tunnel would be installed for use during project construction. A roller-compacted concrete dam structure is assumed. It is anticipated that much of the material used to build the dam would be excavated within or near the reservoir pool area. Figure VII-1 shows a conceptual layout for the Bull Run option, including Dam 3 and attendant facilities.

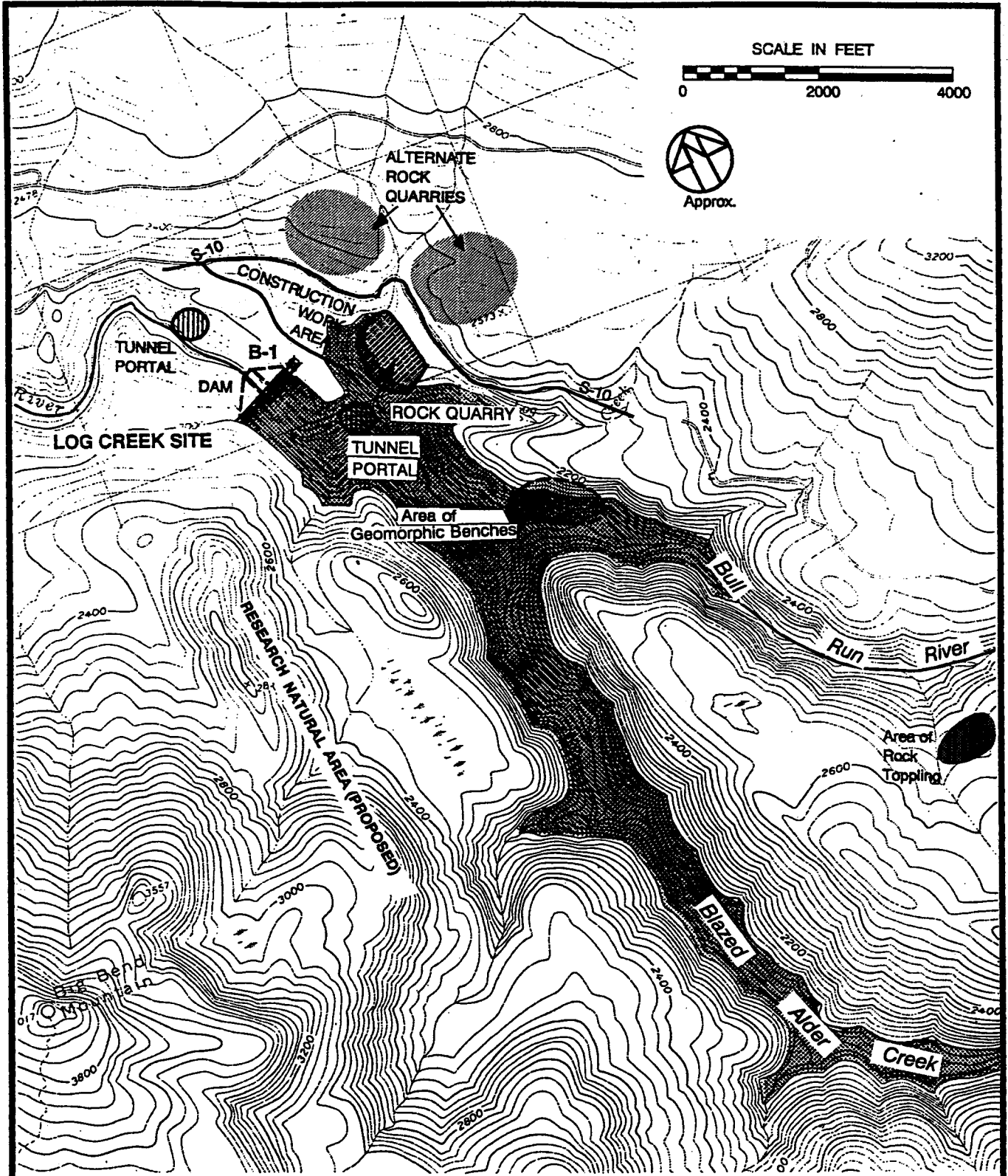

Figure VII-1
 Log Creek Reconnaissance Area
 REGIONAL WATER SUPPLY PLAN - PHASE 2

NOTES:

1. Helicopter reconnaissance, May 13, 1994
2. Reconnaissance along river, July 8, 1993
3. Reconnaissance of construction areas and geologic hazards, May 26 and June 2, 1994



SQUIER ASSOCIATES

Lake Oswego, Oregon

At a maximum dam height of about 400 feet, this project could provide an additional 67,520 acre-feet, or about 22 billion gallons of storage. Assuming no filtration plant, usable storage would be about 19 billion gallons, nearly double the existing usable reservoir storage in the watershed. The reservoir pool would cover 466 acres. It is estimated that the average daily peak season availability would increase by about 134.8 mgd (with 95% annual reliability). Daily delivery capacity would increase by 270 mgd.

The representative site for the dam and reservoir is located in a narrow, steep portion of Bull Run River canyon just downstream of Log Creek and about one-half mile downstream of the confluence of Blazed Alder Creek and the Bull Run River. The site is also located upstream from the pool behind Dam 1 (Bear Creek Reservoir). An area map of existing Bull Run storage reservoirs and the Dam 3 representative site is shown in Figure VII-2.

This site was first identified in the mid-1970s, as it appeared to furnish suitable topography for a large dam and reservoir project. The site was chosen for purposes of the RWSP after performing a preliminary geotechnical and environmental comparison of seven potential sites in the Bull Run watershed. Both this analysis and a subsequent core drilling confirmed that the site appears to be relatively promising from a geotechnical perspective. Key environmental issues include potential impacts on threatened and endangered species, wildlife habitat, wetlands, and fish as discussed below.

The representative regional storage for an expanded Bull Run source would be located at the current Powell Butte terminal reservoir site. (See Chapter VIII for a brief discussion of why this site was selected.)

BULL RUN VICINITY MAP

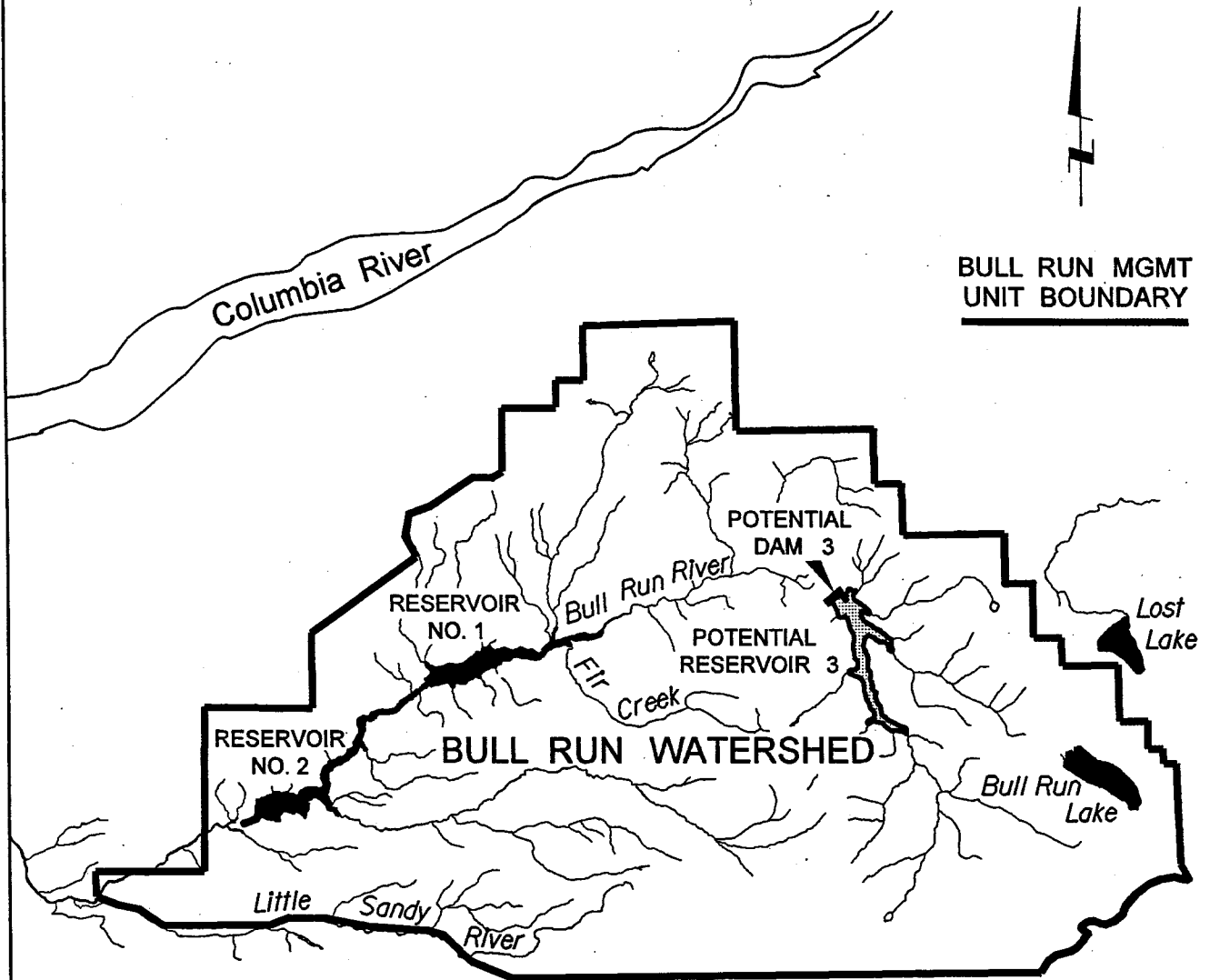

**BULL RUN MGMT
UNIT BOUNDARY**

Figure VII-2

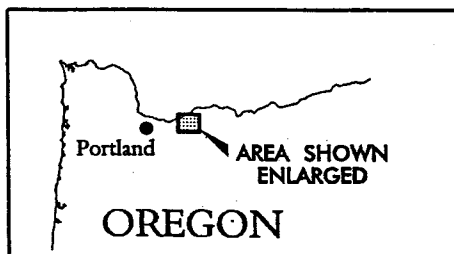

BULL RUN VICINITY MAP		
CITY OF PORTLAND BUREAU OF WATER WORKS		
DATE: AUG. 1995	SCALE: NONE	DIRECTORY: /USR2/USFS
DATE PLOTTED: 3-AUG-1995	DRAWN BY:	FILE NAME: RES 3 MAP

Water Availability

Currently, the City of Portland and 19 wholesale customers use about 25% of the Bull Run Watershed's total water yield, or about 37 billion gallons per year. In 1909, the Oregon Legislature granted Portland the exclusive right to use of the Bull Run River water for municipal purposes. The City of Portland has and could continue to expand the municipal use of Bull Run water without obtaining additional water rights.

The City of Portland has registered a claim with the state to use up to the full Bull Run flow. The registration sets forth an August 1, 1886 priority date. The verification of this claim is subject to the adjudication of the Sandy River Basin.

The City has water rights to divert up to 3,500 cubic feet per second (cfs) of Bull Run Water to generate hydroelectric power at two power stations just below the dams.

Preserving flows to meet aquatic system health objectives is part of the recently established Northwest Forest Plan. However, specific instream flow requirements have not been set for the Bull Run River. The Bull Run River is located upstream of a portion of the Sandy River that is a designated State Scenic Waterway and Federal Wild and Scenic River. The Oregon Water Resources Commission has established flow levels (or "Diack" flows) necessary to meet objectives of State Scenic Waterway authorizing legislation.

The yield of the Bull Run reservoir system will increase if a filtration plant is added at a future date. The elevation to which all Bull Run reservoirs can be drawn down is limited by water quality (turbidity) concerns. The addition of treatment would allow the reservoirs to be drawn down to a lower level, and would thereby increase the available supply. The RWSP analysis does not assume future filtration on the Bull Run.

Table VII-3 summarizes the reliability of Bull Run yield with a third reservoir. The figures in the table assume no filtration. The table indicates, for example, that a Bull Run system with a third dam will be able to provide an average seasonal yield of 280.9 mgd in 95% of the years based on the 65-year period of record.

Table VII-3
BULL RUN RESERVOIR SYSTEM
RELIABILITY OF YIELD WITH THIRD DAM AND NO FILTRATION

Total Seasonal Yield mgd	Percent of Years Demand is Met	Percent of Months Demand is Met
271.1	100%	100%
274.5	98%	100%
278.1	97%	99%
280.9	95%	99%
295.0	92%	99%
313.1	89%	98%
317.4	85%	98%
324.5	80%	97%
337.1	71%	96%
356.8	60%	94%
372.2	51%	92%

Environmental Impacts

Development of a third dam and reservoir in the Bull Run could have several potential environmental impacts:

- ***Fish:*** Cutthroat and rainbow trout and coho salmon are among the fish species that could be affected. Resident fish populations in the upper Bull Run watershed could be further segregated or isolated from spawning or rearing habitats. The project would reduce riverine habitat, and could cause changes in downstream temperatures. Increased rearing habitat and food availability in the impoundment area could increase fish growth and production capabilities, thus changing species composition. Flow impacts in the Lower Bull Run and Sandy Rivers could change sedimentation rates and water quality, and could affect fish populations and habitat downstream. Some of these impacts could

potentially be mitigated by releasing water from the reservoir system for instream flow purposes. A subsequent study prepared for the Portland Water Bureau by R2 Resource Consultants (3/1/96) indicates that the potential environmental impacts of Dam 3 in regards to fish resources do not appear as severe as predicted during the Environmental Assessment completed for the Regional Water Supply Plan (as illustrated in rating scores in Tables XI-2, XI-5, XI-6, and B-2). This report indicates that substantial fish habitat enhancement can be obtained through moderate flow releases. Additional mitigation can be achieved through reservoir system operation to stabilize flows between Dam 3 and Reservoirs 1 and 2, and potentially by introducing gravel to enhance spawning habitat in the Lower Bull Run River.

- *Wetlands.* A third dam and reservoir could affect riparian wetlands adjacent to the Bull Run river or its tributaries due to disturbance from construction or reservoir filling. The project would cause permanent loss of perennial streamflow and associated riverine wetlands along the river and its tributaries within the potential pool area.

- *Wildlife and Terrestrial Threatened and Endangered Species.* Bull Run Dam No. 3 could potentially affect terrestrial wildlife. The project would result in the loss of about 640 acres of high quality, diverse wildlife habitat. Of key concern are potential impacts on the northern spotted owl population resulting from the loss of approximately 330 acres of suitable owl habitat in the reservoir pool area. A small population of Howell's daisy, a candidate for federal listing as a threatened or endangered species, could be flooded by the reservoir, depending on the exact location of the plants and the pool level. Bald eagle, common loon, fir club-moss, and a plant called kruhsea are also found in this vicinity, but impacts to these species are unlikely. Loss of habitat would affect amphibians, reptiles and small mammals. Larger mammals and birds would be displaced, and might be unable to find suitable unoccupied habitat.

Some 408 plant and animal species of concern have been identified for analysis and protection pursuant to the President's Northwest Forest Plan. The Forest Plan requires the Bull Run Watershed (and other designated Key Watersheds and Riparian Reserves) be analyzed to assess the condition of specified resources. A compilation of existing species data and possible inventories of species expected to exist in the area will

be conducted as part of the required Watershed Analysis (scheduled to begin during 1996). Providing direct mitigation for impacts on wildlife and habitat would be challenging. However, opportunities to acquire, protect, or restore alternate habitat areas have not yet been explored.

- *The President's Northwest Forest Plan.* As part of the President's Northwest Forest Plan, Bull Run Watershed has been made part of the Mt. Hood National Forest Late-Successional Reserve. The purpose of the designation is to maintain a functional, interactive, old growth forest ecosystem. The Bull Run has also been designated a Tier 2 Key Watershed. The Tier 2 Watershed designation was applied to highlight the importance of maintaining high water quality.

No programmed timber harvest is allowed in late-successional reserves. Thinning can occur under very stringent conditions. The Standards and Guidelines prohibit or discourage land management activities that adversely affect the riparian areas. The Tier 2 Key Watershed designation requires strict conformance with an Aquatic Conservation Strategy that is included in the Standards and Guidelines. The Aquatic Conservation Strategy involves maintaining instream flows to sustain riparian, aquatic, and wetland habitats, and maintaining and restoring species composition and the structural diversity of aquatic dependent species. This requirement could be imposed on a third dam and reservoir in the Bull Run Watershed.

Because the Forest Plan was only recently adopted, the process for review and action on a third dam in the Bull Run is uncertain. The Standards and Guidelines would require that siting a third dam in the Bull Run be evaluated as a special case subsequent to completion of a Bull Run Watershed Analysis and necessary amendments to the Mt. Hood Forest Plan and Bull Run Final Environmental Impact Statement (FEIS).

The Standards and Guidelines include language indicating that new development proposals addressing public needs or providing public benefits may be approved if it can be shown that adverse environmental impacts can be minimized or mitigated.

The Forest Service has not established protocols for environmental impact minimization and mitigation for Late-Successional Reserves and

Key Watersheds. Such definitions may emerge from the Watershed Analysis phase of the Forest Plan's implementation. Mitigation may include rehabilitation of downstream waterways, flow augmentation, stabilization or removal of forest roads, or reestablishment of riparian corridors.

Raw Water Quality

The quality of the Bull Run source, including health-related constituents as well as aesthetic aspects (taste, odor, and hardness), is excellent. Currently, Bull Run water does not require treatment, other than chlorination followed by ammoniation, to meet State and Federal drinking water regulations. It is one of the few remaining unfiltered surface water supplies in the United States. A filtration plant has not been necessary due to the very high quality of the water delivered from the watershed. The watershed's protected status has been very important in keeping the Bull Run supply unfiltered.

Concerns have been raised about the possible water quality impact of construction activities associated with developing a third reservoir in the Bull Run watershed. As the third reservoir would be constructed upstream of the two existing reservoirs, it is possible that construction activity could significantly reduce downstream water quality. Also, the creation of a new reservoir behind the third dam could cause short- to medium-term (two to three years after the reservoir is filled) water quality problems. Preliminary investigations indicate that mitigative measures could be taken during planning and construction to minimize these potential impacts (see below). Nonetheless, it is possible that another reservoir within the Bull Run watershed could require the development of a filtration plant to continue to meet drinking water regulations.

If required, Bull Run water can be effectively treated (filtered and disinfected) to meet all regulations. The City of Portland's recently completed Bull Run Water Treatment Pilot Study developed preliminary design criteria and preliminary cost estimates for different treatment alternatives if more stringent treatment is eventually required.

Vulnerability to Catastrophic Events

As a protected watershed, the Bull Run's vulnerability to upstream spills is minimal. However, the small size and steep topography of the watershed makes it particularly

prone to a catastrophic slide. Its heavily forested nature, the difficult accessibility to much of the watershed, and the relatively small flows also make this source particularly susceptible to increased sediment and nutrient loads from naturally-caused fires. The protected status of the Bull Run sharply reduce the likelihood of human-caused fires.

The volcanic hazard posed to Bull Run is relatively low to moderate. Mount Hood is one of the less active volcanoes in the Cascade Range. At its nearest point, the watershed is about six miles northwest of Mount Hood. Because prevailing winds generally flow from the west to southwest, most ash would likely drift east and northeast, and not towards the watershed. The greatest risk would be a major mudflow down the Sandy River that could sever conduit bridge crossings which carry the water supply to the terminal storage facility on Powell Butte. Reinforcement of those crossings would substantially reduce this risk.

Ease of Implementation

The President's Forest Plan and the Endangered Species Act raise some extremely difficult legal and regulatory hurdles for Dam 3.

Treatment Requirements

As noted, the Bull Run source is currently unfiltered. Current treatment includes chlorination and ammoniation. While development of a third dam might require filtration to deal with construction impacts, it is assumed (pending more detailed analysis), that mitigative measures will enable the region to avoid this expense.

Costs

Tables VII-4 and VII-5 present the estimated capital and operating costs associated with developing Bull Run Dam 3, assuming that filtration is not necessary.

Clackamas River Diversion

Description of Option

The Clackamas already has four existing and planned intake and treatment facilities. An analysis of potential sites other than these revealed none that merited further exploration at this time. Thus, it was recommended that new capacity be developed at one or more of the existing or planned sites. The Clackamas basin providers identified four alternative configurations of where capacity might be developed. They include:

- *Alternative 1.* Existing facilities would be maintained and future expansion would occur at a consolidated facility. This alternative would utilize the three existing facilities (Clackamas River Water (CRW), South Fork Water Board, and the City of Lake Oswego) and the planned Oak Lodge plant in their current or planned configurations and capacities. Additional needs would be met by a new consolidated facility adjacent to the current Clackamas River Water site.
- *Alternative 2.* A consolidated facility would be provided for all flows. This alternative would phase out existing base capacity river intakes and treatment plants upon implementation of a consolidated intake and treatment facility at the CRW site.

Table VII-4
BULL RUN RESERVOIR NO. 3
WITHOUT FILTRATION PLANT
CAPITAL COST SUMMARY
(in millions of dollars)

Incremental Maximum Day Capacity (mgd)	Dam/Reservoir		Pipeline		Headworks Improvements	Treatment Improvements	25% Contingencies	20% Engr., Admin.	Total Capital Cost
	Volume (ac-ft)	Cost	Dia/Length	Cost					
270	58,800	111.3	102-90"/21 miles	100.0	5.0	1.5	54.5	43.6	315.8

Notes:

1. EENR CCI index = 5,800
2. Environmental mitigation costs, if any, are not included in the capital costs.
3. Pipeline costs include those for Headworks to Powell Butte.

Table VII-5
BULL RUN RESERVOIR NO. 3
WITHOUT FILTRATION PLANT
ANNUAL OPERATIONS & MAINTENANCE COST SUMMARY
(in millions of \$ per year)

Incremental Maximum Day Capacity (mgd)	Labor	Chemicals	Maintenance/Supplies	Reservoir/Dam O&M	25% Contingencies	Total Annual Cost
270	0.50	0.2	0.50	1.11	0.58	2.89

- *Alternative 3.* All existing and planned facilities would be expanded, and a consolidated facility would be provided if needed. This alternative would provide for expanding each of the existing facilities beyond the levels assumed in the base case. The expansions would include up to 8.5 mgd from OLWD, 10 mgd from SFWB, 50 mgd from CRW, and 18 mgd from Lake Oswego, for a total capacity increment of 86.5 mgd beyond the base case. Additional capacity beyond these expansions would come at the consolidated CRW site.

- *Alternative 4.* All existing facilities would expand as currently planned and may be necessary for ultimate flows. This alternative is similar to Alternative No. 3, except consolidated facilities would not be developed.

Figure VII-3 shows the four existing and planned facility sites for the Clackamas River option. Figure VII-4 shows an aerial view of the representative consolidated facility site adjacent to the existing Clackamas River Water facility.

To the extent development occurs on the Clackamas, providers will have to determine which of these configurations is desirable. For purposes of the RWSP analysis, the costs and environmental impacts associated with Alternative 1 were used. The differences in costs among the four alternatives are not significant. There may be some differences in some of environmental impacts that would need to be explored if a configuration other than Alternative 1 were pursued.

The representative site for a terminal reservoir associated with Clackamas expansion is Forsythe Road. (See Chapter VIII for a brief discussion of why this site was selected.)

Regional Land Information System

Figure VII-3 Vicinity Map

- Clackamas Area Sites
- River
- Project Site
- County
- UGB

400 NE Grand Ave
Portland, OR 97232-7756
(503) 797-1700

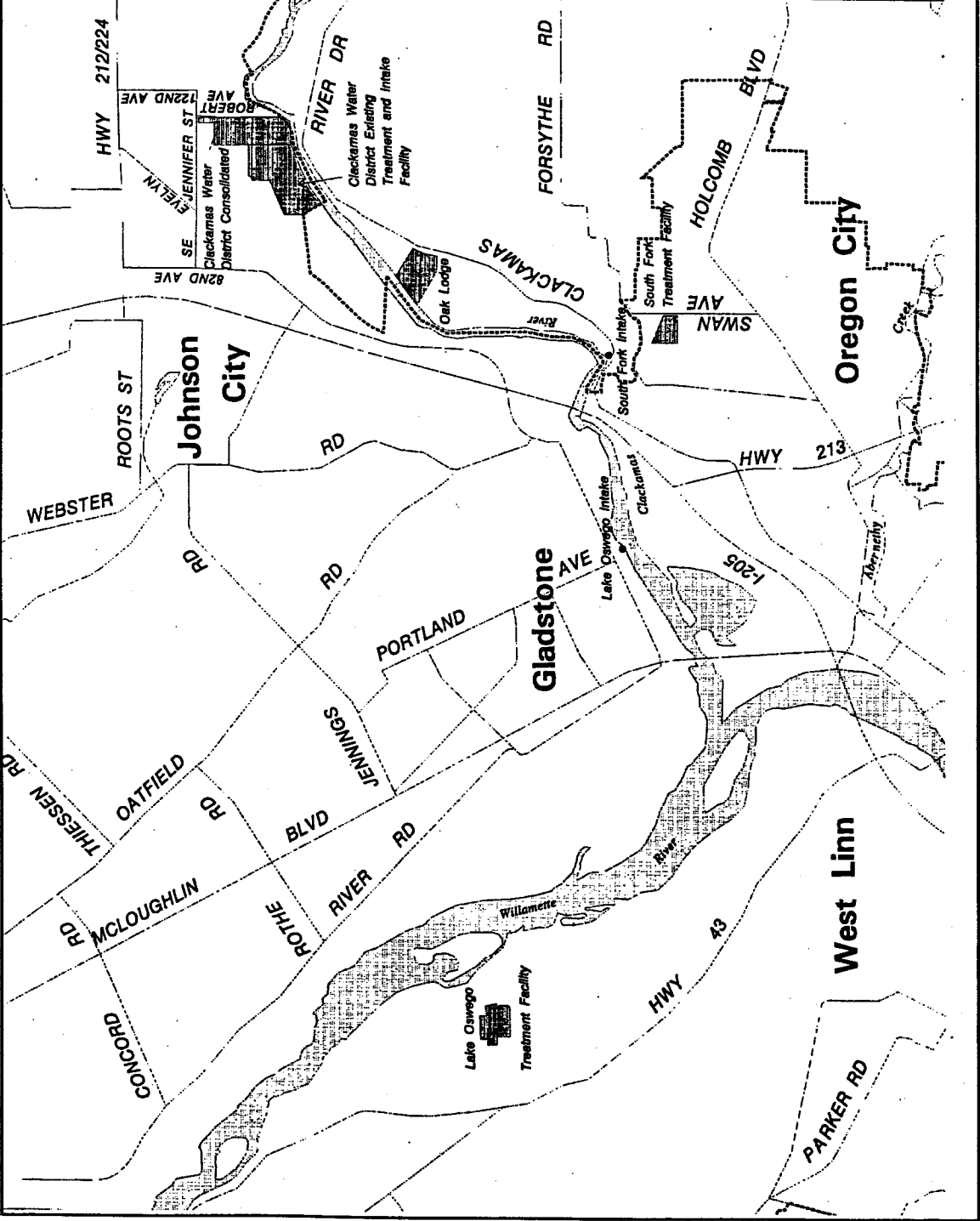

**Vicinity Map
Clackamas Water District
Consolidated Site**

Aerial Photography by WAC Corporation,
Eugene, Oregon.

Figure VII-4

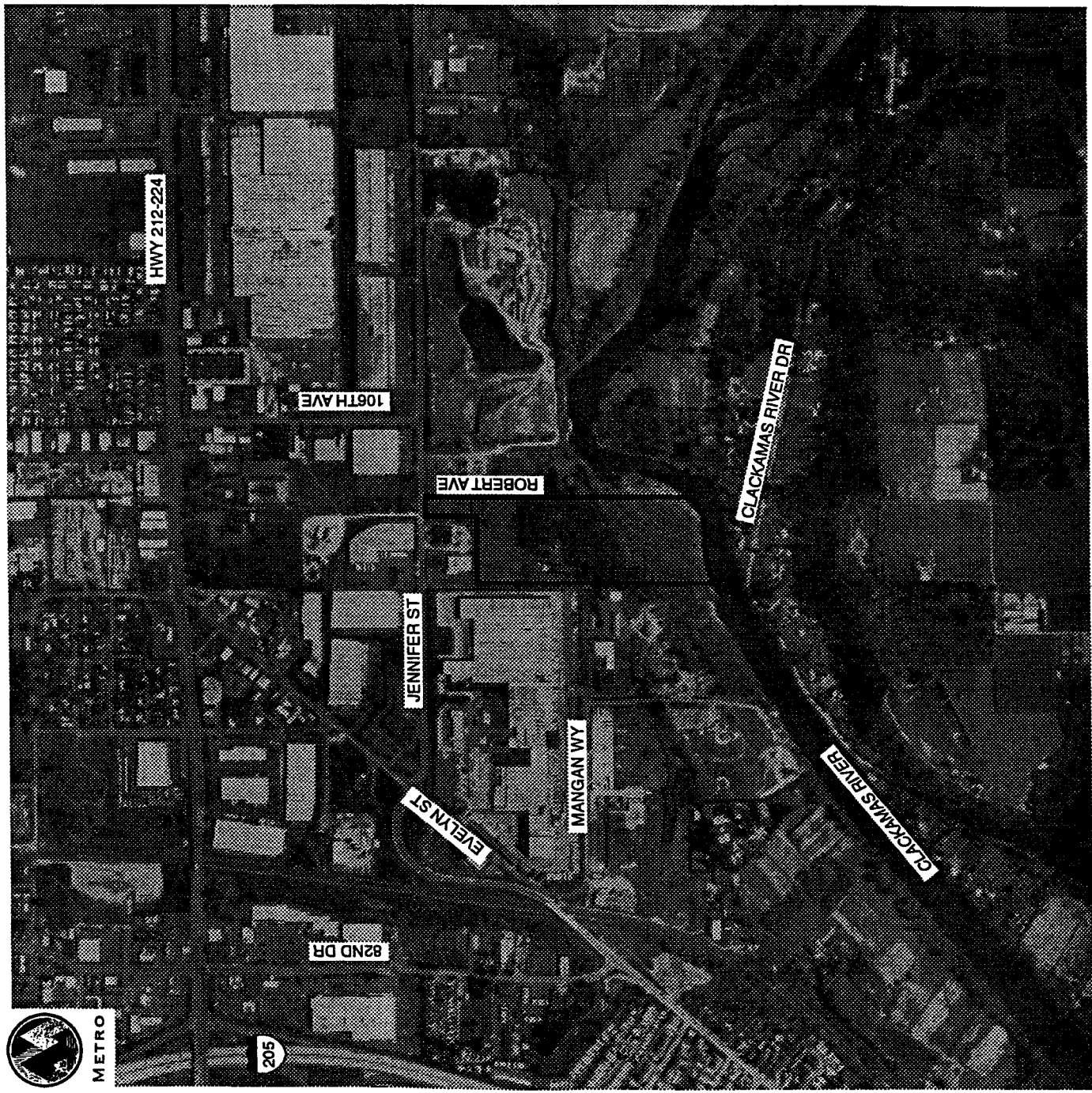
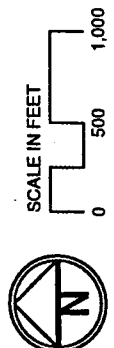

Water Availability

Municipalities hold water rights to 265 cfs or 171 mgd on the Clackamas River. Of these, 66 mgd have already been developed, an additional 49 mgd have a priority that is higher than in-stream water rights on the river, and 56 mgd have a priority lower than in-stream rights. The remainder could be developed to meet future demand growth.

As described in Chapter VI, the 22.5 mgd of additional Clackamas River supply scheduled for development in the near-term will increase the capacity on the Clackamas to 88.5 mgd. Thus, about 83 mgd of additional water rights remain that could be utilized as part of the regional supply.

Table VII-6 summarizes available flows on the Clackamas, using daily flow data.

The existing Lower Clackamas municipal diversions (66 mgd) and the 49 mgd of "higher" priority rights were found to be available 100% of the time (that is, on 100% of all days). The 56 mgd of "lower" priority rights were found to be available almost 95% of the time. Instream flow requirements were satisfied more than 98% of the time. On a month-by-month basis, the 56 mgd of lower priority rights were available 100% of the time in all months except September, October, and November.

Environmental Impacts

Development of additional diversion capacity on the Clackamas can be expected to have the following environmental impacts:

- *Fish:* The impact of additional water supply development on fish populations depends critically on the magnitude of the diversion. Maximum diversions could result in greater fishery impacts. Reduced instream flows may reduce fish spawning and rearing habitat, slow fish migration and isolate riparian cover habitat. Additional study using an Instream Flow Incremental Methodology (IFIM) is required to better understand the possible impacts.

Both types of impacts (i.e. those related to flows and to intake structures) are significantly reduced with smaller diversions. For analytical purposes, the RWSP uses 50 mgd as the level at which fishery impacts become more significant.

- Wetlands:** Expansion of Clackamas River water supplies is expected to have minimal impacts on wetlands. Construction of supply facilities at the representative site for a consolidated facility could avoid on-site wetlands. Impacts to wetlands due to expansions of existing facility sites are expected to be minor. Impacts can be mitigated by minimizing site disturbances and providing enhancement of nearby riparian areas and wetlands. Flow changes are not expected to affect downstream wetlands; however, ongoing assessment of flow reduction impacts on downstream floodplain wetlands is recommended.

**Table VII-6
WATER AVAILABILITY ON THE CLACKAMAS RIVER:
AVAILABLE FLOW FOR ALL MONTHS
(millions of gallons per day)**

Parameter	Mean Daily Flow Percent Exceedence								
	100 %	99%	98%	97%	95%	90%	80%	70%	50%
Flow in River	202	422	456	474	502	563	689	874	1,864
Flow in River after Existing Diversions	136	356	390	408	436	497	623	808	1,798
Divertible under Higher Priority Water Rights	49	49	49	49	49	49	49	49	49
Available to meet Instream Flow Requirements	87	307	341	359	387	448	574	759	1,749
Divertible under Lower Priority Water Rights	0	0	0	0	37	56	56	56	56
Total New Supply	49	49	49	49	86	105	105	105	105

- Recreation:** Facility siting and additional diversions on the Clackamas River could adversely impact instream recreation opportunities. Potential impacts could be mitigated through facility design and signage, along with possible establishment of riverside trails.

Raw Water Quality

The Clackamas River's raw water quality is generally good compared to other regional source options, and is very good compared to sources nationwide. The river has a low incidence of natural and human-caused contaminants. Some constituents do exceed drinking water standards, including turbidity and microorganisms. Sporadic nutrient (e.g., nitrogen, phosphorus) increases can occur during low-flow periods, causing taste and odor problems. The water can be easily treated to meet drinking water standards.

The Clackamas is a small watershed with few potentially contaminating upstream uses. Much of the watershed is national forest land, and much of the river has a State Scenic Waterway designation. The watershed does not, however, offer the degree of protection offered by the Bull Run.

The taste of Clackamas water is good although odor-causing compounds require seasonal treatment. Hardness is low, but not as low as Bull Run.

Vulnerability to Catastrophic Events

The size of the Clackamas basin and resulting dilution capacity is larger than the Bull Run system. The Clackamas basin is also somewhat less steep than the Bull Run. The most significant landslide risk on the Clackamas occurs well upstream from any potential intake sites.

While a risk exists of upstream spills from wastewater treatment plants, industrial plants, agricultural lands, and transportation routes, this risk is much less significant than on the Columbia and the Willamette.

As with Bull Run, the Clackamas watershed is vulnerable to fire. Because it is more accessible than the Bull Run, the possibility of human-caused fires is increased. This accessibility also makes firefighting somewhat easier.

The vulnerability of the Clackamas to volcanic events is fairly low. The headwaters of the Clackamas do not drain from any of the more active volcanoes. Lesser volcanoes include Olallie Butte and Sisi Butte, about which little is known. No information suggests either of these volcanoes have erupted in the last 10,000 years. The risk to the Clackamas would be primarily from ash fall from a volcano outside the drainage basin. The nearest volcano is Mount Hood which is 12 miles north of the Clackamas River's headwaters. There is a low risk of ash fall within the drainage basin.

Ease of Implementation

The most difficult permitting issues on the Clackamas relate to fish. Resolution of many of these issues must await further study. Undue permitting difficulties are not anticipated.

Treatment Requirements

Based upon review of existing raw water quality and operation of current Clackamas River treatment plants, it was recommended that conventional treatment, which includes sedimentation basins, be provided. Through long-term pilot testing, it may be possible to establish direct filtration as an acceptable treatment for Clackamas River water. Direct filtration could realize potential cost and land savings.

It was assumed that granular activated carbon (GAC) would be used as the primary filter media to protect against tastes and odors and to provide a barrier against accidental spills of organic material.

Post-filter GAC absorbers were not included in the preliminary WTP process design due to the lack of detectable synthetic organics in the river. Three hours of clearwell storage were assumed for the WTP for post-filtration disinfection purposes. Ozone was not included for preliminary treatment since pre- and/or post-chlorination were determined to be adequate for proper disinfection and to meet proposed water quality regulations.

Capital and Operating Costs

Tables VII-7 and VII-8 present estimated capital and operating costs of various plant sizes at the consolidated Clackamas site.

Table VII-7
CLACKAMAS RIVER SOURCE
CONSOLIDATED INTAKE AND TREATMENT PLANT
CAPITAL COST SUMMARY
(in millions of dollars)

Maximum Day Capacity (mgd)	River Intake and Raw Water Pump Station		Raw Water Pipeline		Water Treatment Plant	Finished Water Pump Station	25% Contingencies	20% Engr., Admin.	Total Capital Cost
	Hp	Cost	Dia./Length	Cost					
25	490	2.0	36"/0.5 mi.	0.53	21	5.2	7.2	5.7	41.7
50	980	3.3	48"/0.5 mi.	0.82	36	8.3	12.1	9.7	70.2
75	1,480	4.7	66"/0.5 mi.	1.19	52	10.7	17.1	13.7	99.5
100	1,980	5.6	72"/0.5 mi.	1.40	62	12.9	20.5	16.4	118.8
160	3,160	8.2	84"/0.5 mi.	1.50	88	17.8	28.9	23.1	167.5

Notes:

1. ENR CCI index = 5,800.
2. Environmental mitigation costs, if any, are no included in the capital costs.

Table VII-8
CLACKAMAS RIVER SOURCE
CONSOLIDATED INTAKE AND TREATMENT PLANT
ANNUAL OPERATIONS & MAINTENANCE COST SUMMARY
(in millions of dollars per year)

Maximum Day Capacity (mgd)	Labor		Power		Chemicals	Sludge Disposal	Maintenance/Supplies		25% Contingencies	Total Annual Cost
	Labor		Pumping	Treatment Plant			Pumping	Treatment Plant		
25	0.35		0.50	0.04	0.06	0.03	0.10	0.35	0.36	1.79
50	0.50		1.00	0.08	0.13	0.05	0.15	0.50	0.60	3.01
75	0.75		1.48	0.12	0.18	0.08	0.20	0.65	0.87	4.33
100	0.75		1.95	0.15	0.25	0.10	0.23	0.80	1.06	5.29
160	1.00		3.09	0.25	0.39	0.16	0.33	1.20	1.61	8.03

Note: Power costs for pumping include those for raw water and finished water pump stations.

Willamette River Diversion

Description of Option

The Willamette Basin is the largest river basin in Oregon. The basin has an area of 11,000 square miles and a total population of about two million residents, which is about 70% of Oregon's total population. The basin also contains some of Oregon's most productive agricultural lands, and supports important fishery resources. Water-dependent and water-related recreational opportunities abound in the basin's lakes and streams.

Currently, the Willamette River is not used as a municipal water source for the Portland metropolitan region. Upstream, the river is used for municipal purposes by the City of Corvallis.

The Port of Portland has a water right, and is developing a non-potable water system to use up to about 22 cubic feet per second (cfs) of water from the Willamette for industrial purposes.

Flows in the Willamette River Basin are influenced substantially by releases from 13 upstream reservoir projects owned and operated by the U.S. Army Corps of Engineers (the Corps). More than half the flows are supplied through storage releases from August through October. To date, the primary use of these projects has been for flood control. Over time, the reservoirs themselves have become popular flat-water recreation facilities. The Bureau of Reclamation holds water rights to use the total usable storage of 1.6 million acre-feet for irrigation. Only about 3% of this amount has been contracted for irrigation use downstream.

The Corps, the Oregon Water Resources Department, and other stakeholders have proposed that a reauthorization study be conducted to determine how stored water should be allocated and how the reservoirs should be operated in the future. The study is currently underway and is expected to be completed by the year 2000.

The instream water right on the Willamette River mainstem at Wilsonville is 1,500 cfs year-round (for natural flow). There is also a minimum perennial streamflow at this location of 4,700 cfs year-round for releases from upstream storage reservoirs. These instream flows are set at identical levels from above Willamette Falls at Oregon City to the mouth of the river (at its confluence with the Columbia River).

The Oregon Department of Environmental Quality (DEQ) has also established a water quality flow target of 6,500 cfs from Salem to the river's mouth. The DEQ presumes that this amount will be available to help assimilate pollutants when reviewing applications to discharge into the river.

The RWSP evaluated the possibility of a new river intake and treatment plant on the Willamette. The largest diversion considered in any of the resource strategies discussed in Chapter XI is 160 mgd.

Four sites were initially considered for the raw water intake and pumping station. These were narrowed down to two sites near Wilsonville in the section of the river known as the Newberg Pool. The advantages of these sites include:

- Proximity to potential users of Willamette River water, including Wilsonville, Canby, Tualatin, Sherwood, and the Tualatin Valley;
- Topography and access; and
- Better overall raw water quality than locations farther downstream.

Four treatment plant sites were also considered, one of which was adjacent to one of the two potential intake sites on the river; the other three were inland. Based on preliminary environmental analyses and other technical considerations, it was determined that the representative site for the intake and raw water pump station as well as for the treatment plant would be located just upstream (west) of the existing railroad bridge in Wilsonville on the north side of the river on property currently owned by Oregon Pacific which is used for sand and gravel operations. Figure VII-5 shows the location of the Willamette representative facility site. Figure VII-6 presents additional detail of this site.

The terminal storage representative site is on Cooper Mountain. (See Chapter VIII for a brief discussion of why this site was selected.)

JOB No. 3434.0016 FILE No. /usr/proj/metro/f10995.dgn Plot Date/Time: 11-AUG-1995 14:27

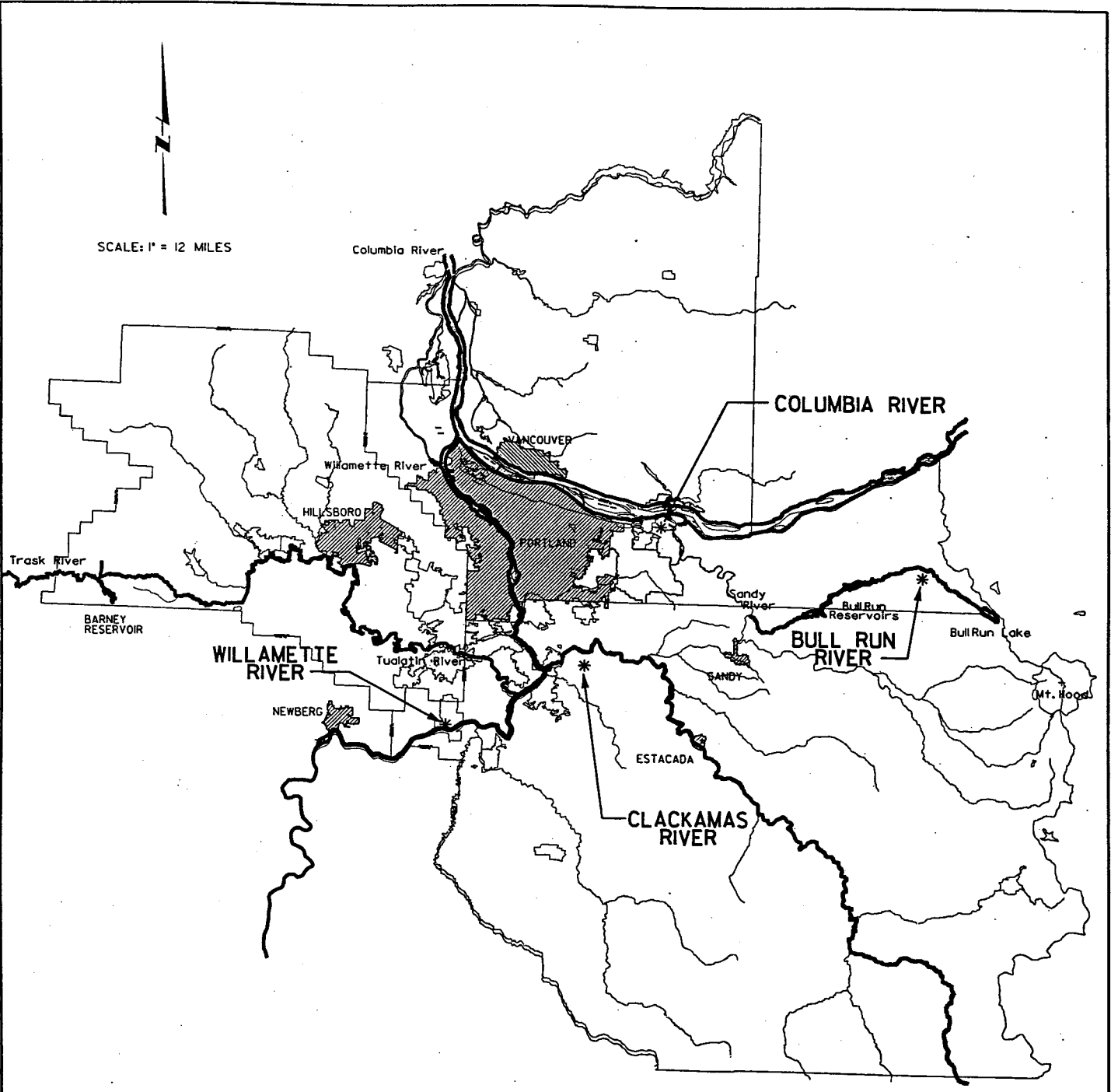

NOTES:

- 1. (*) INDICATES SOURCE OPTION.
- 2. ASR SITES NOT SHOWN ON THIS MAP.

Figure VII-5

Source Options

REGIONAL WATER SUPPLY PLAN - PHASE 2



MONTGOMERY WATSON

Portland, Oregon

Figure VII-6 Vicinity Map

Willamette River
Site

-  River
-  Project Site
-  County
-  UGB

600 NE Grand Ave
Portland, OR 97232-2736
(503) 797-1700

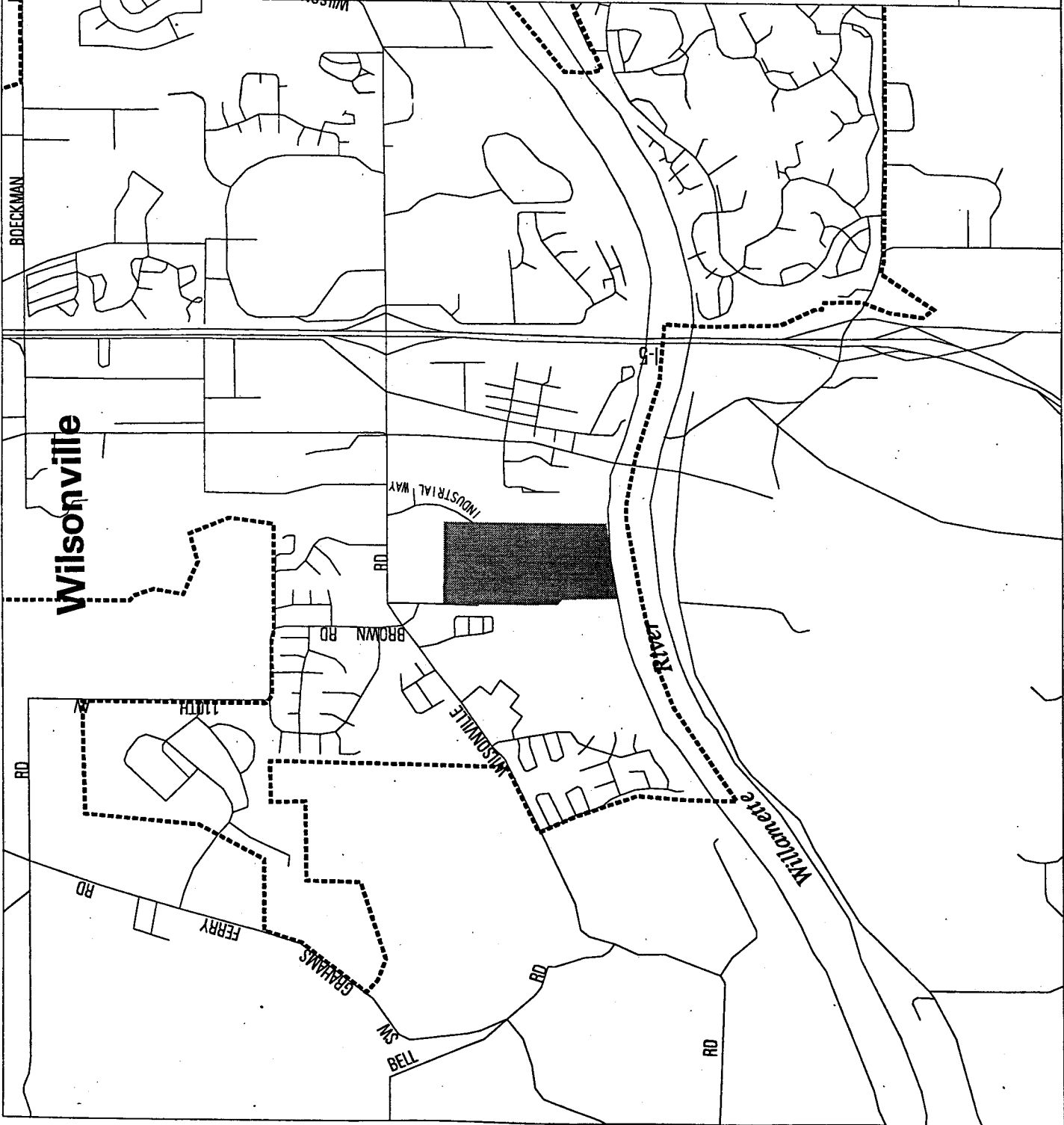

Water Availability

Median daily flows in the Willamette River at Wilsonville range from about 6,300 cubic feet per second (cfs) in August to about 48,000 cfs in January (based on mean daily flow frequencies from 1949 to 1972). Flows can and do run considerably lower and higher than this with the extreme low flow for that period at 3,600 cfs and the extreme high flow at 339,000 cfs.

A number of uncertainties make availability assessments for the Willamette River difficult. For example, the minimum perennial streamflows await conversion to instream water rights (pursuant to state law). The total flow amounts may change prior to conversion. In addition, Portland General Electric has registered a pre-1909 claim for substantial flows on the lower Willamette River at Willamette Falls. It is possible that when the river is adjudicated (probably some years from now), this claim would lower the reliability of this source for municipal purposes in the Portland region. At the same time, the Oregon Water Resources Department has been asked to reserve a large amount of natural flow and stored water to meet future municipal and irrigation demands in the basin. Finally, the ultimate fate of the Corps storage and the availability of stored water for municipal purposes remains uncertain.

Despite the complexity of water allocation issues on the Willamette, an ample supply of water exists in the river and in storage, and there are many opportunities for resolving these issues in a cooperative and creative manner. Discussions among interested parties have been initiated and will continue.

Table VII-9 summarizes available flow in the Willamette. Water to meet the 154 mgd of existing Phase 2 participant permits is available 97% of the time. Flows to satisfy these permits plus the 319 of pending applications are available 88% of the time. Higher flows are available for most of the year, indicating the Willamette could be very useful as an aquifer storage and recovery (ASR) supply source.

Table VII-9
WATER AVAILABILITY ON THE WILLAMETTE RIVER
AVAILABLE FLOW FOR ALL MONTHS
(millions of gallons per day)

Parameter	Mean Daily Flow Percent Exceedence								
	100%	99%	98%	97%	95%	90%	80%	70%	50%
Flow in River Upstream Diversions	4,149	4,149	4,154	4,160	4,173	4,307	5,531	7,377	12,103
Flow in River after Minimum Instream Flows	3,179	3,179	3,185	3,191	3,203	3,337	4,562	6,407	11,133
Divertible under Existing Water Rights	154	154	154	154	154	154	154	154	154
Divertible under Applications	319	319	319	319	319	319	319	319	319
Total New Supply	473	473	473	473	473	473	473	473	473

Environmental Impacts

A discussion follows of the key environmental impacts from developing the Willamette source.

- ***Fish:*** Development of a water supply system could adversely impact fish populations for large diversions. Impacts may occur due to flow changes and potential entrapment, injury, or death at the intake facility. Reduced flows during summer months could cause migration delays, associated straying, and prespawning mortality. Oregon Chub is the only fish species on the Willamette River listed under the federal Endangered Species Act. Chub have not been observed in the lower mainstem since 1970, but are believed to exist in the tributaries. Several additional Willamette species have been petitioned for listing or have been listed as species of concern.

Appropriate fish screening design can reduce fish impacts at the intake. Flow augmentation to mitigate impacts may be achievable by contracting for storage in Corps' reservoirs upstream. The presence of salmonid fry and the potential for larval stage sturgeon, combined with low-flow

velocities, may warrant the use of micro-screens or bypass facilities to foster safe fish passage. Enhancement of Seely Ditch and Wood Creek (located on the representative site) could also enhance fish resources.

- **Wetlands:** Construction and operation of a Willamette River water supply system could result in enhancement of on-site riparian and wetland areas currently disturbed by gravel operations. On-site construction is expected to be located within existing disturbed areas, thus minimizing the possibility of affecting wetland and riparian areas. The effects on downstream wetlands and backwater areas due to flow reductions are expected to be minor. There are several ways to avoid or mitigate impacts to wetland areas. These include creating an environmentally sensitive project design, revegetating disturbed areas, and enhancing wetland areas on-site or nearby. Other methods include reducing the diversion level or augmenting flow with stored water from upstream Corps' reservoirs.
- **Wildlife and Habitat:** Development of a water intake and treatment facility could actually enhance wildlife and habitat at the representative site as construction could be concentrated in already disturbed areas. Species potentially affected include deer, squirrels, bullfrog, roughskin newts, songbirds, red-tailed hawk, and raccoon. In large part, impacts can be prevented by designing the project to minimize disturbance, avoiding disturbance of stream corridor habitat on the site, and restoring existing disturbed areas, possibly resulting in an overall enhancement of wildlife habitat. Removing the gravel operation would also significantly reduce noise on the site, which currently proves a wildlife deterrent.
- **Land Use:** Potential water supply intake and treatment facilities are allowable through a public hearing process under current land use and zoning designations for the representative site evaluated. However, City of Wilsonville planning officials suggest it would be most appropriate to rezone the site to a Public Facility Zone. The southern portion of the property is located in the Willamette Greenway, which involves special development standards to ensure the integrity and aesthetic quality of the natural environment is preserved. A possible mix of uses has been suggested that includes a treatment facility, designated trails, enhanced natural areas, public river access, and a small community park.

A regional storage facility could be sited on Cooper Mountain with the issuance of a conditional use permit by Washington County and efforts to avoid ponderosa pine stands and headwater streams.

Raw Water Quality

The relative quality of Willamette River raw water is generally fair relative to other regional sources and good relative to sources nationwide. Tualatin Valley Water District's pilot treatment study of the Willamette River concluded "historical water quality records, as well as data collected during the pilot study indicate that the Willamette River is a high-quality source water."

Upstream industrial and municipal discharges and nonpoint pollution sources may impair the Willamette's water quality. Some raw water quality constituents exceed drinking water standards, including turbidity, microorganisms, and perhaps aluminum and a few trace organics. Concentrations of general and regulated inorganics are low; however, certain metals have been reported at concentrations exceeding maximum contaminant levels established in the Safe Drinking Water Act. Turbidity in the Willamette is low to moderate. Its mineral quality is similar to the Clackamas River.

Studies have identified fish deformities in the Newberg Pool area where the representative intake site is located. A relationship between water quality and this phenomenon has not been established. The Oregon Department of Environmental Quality is now conducting sediment analyses in an attempt to determine the source(s) of the fish deformities.

Aesthetically, the water's taste is good as monitored by upstream users. Odor-causing compounds have been noted upstream, requiring seasonal treatment. Hardness is fairly low, averaging around 20 mg/l.

The water can be readily treated to meet Safe Drinking Water Act standards, as documented in the Tualatin Valley Water District study. In addition, the drainage basin is large, and has a fairly high dilution capacity in the mainstem. There are also a number of watershed management efforts beginning or underway throughout the Willamette basin.

Vulnerability to Catastrophic Events

The headwaters for the Willamette River are in the High Cascades, which include many volcanoes with major volcanic activity within the last 10,000 years. Examples include Mount Mazama (Crater Lake), Three Sisters, and the MacKenzie Pass area. Some of these sites could generate a mudflow. However, distances from volcano to potential intake locations are large; consequently, little risk exists of a mudflow directly reaching an intake. However, the river could remain turbid for several years.

The only significant landslide potential is far upstream, where geologic formations are prone to slides. The upstream distance significantly reduces the risk to the intake location. Given the size of the watershed, the range of upstream activities, and the large number of bridge crossings, the risk of a catastrophic spill is fairly high. There are many transportation routes near or along the river. The Willamette and its tributaries are somewhat susceptible to fire events, but fire is not considered a major risk.

Ease of Implementation

As described above, the Willamette faces many difficult issues. Chief among these are

- Determining the feasibility of reauthorizing the U.S. Army Corps of Engineers reservoir system. (This could require funding and/or federal legislation);
- Minimum streamflow conversions to instream water rights; and
- Adjudication of pending water rights applications.

However, in the range of diversion sizes considered in the RWSP resource strategies (see Chapter XI), most of these issues become much less significant given the permits to use 154 mgd already held by regional providers.

Treatment Requirements

According to the Tualatin Valley Water District pilot treatment study, “a multiple barrier treatment process can successfully treat Willamette River water to meet stringent water quality and operational goals...and provide drinking water of excellent quality.” For the Willamette, as for the Columbia, the regional providers determined

that, pending the additional study required before development of either of these sources, it was appropriate to assume conservative treatment approaches. Recommended treatment for the Willamette involves disinfection and oxidation through the use of ozone, along with granular activated carbon (GAC) filtration for removal of trace organics. This treatment approach would provide multiple barriers against regulated and unregulated microbial and organic contaminants, and would provide better tasting water.

Capital and Operating Costs

The costs for developing the Willamette source are shown in Tables VII-10 and VII-11.

Columbia River

Description of Option

Currently, the Columbia River is not used as a drinking water source in the Portland metropolitan region. However, the river supplies water to upstream Washington cities such as Kennewick, Pasco, and Richland, along with St. Helens, Oregon, which is downstream of Portland. The Port of Portland has a municipal water right to use up to 15 cubic feet per second from the Columbia River. The water will be used primarily for irrigation and non-potable industrial purposes.

Table VII-10
WILLAMETTE RIVER SOURCE
CAPITAL COST SUMMARY
(in millions of dollars)

Maximum Day Capacity (mgd)	Reallocated Reservoir Storage		River Intake and Raw Water Pump Station		Raw Water Pipeline		Water Treatment Plant	Finish Water Pump Station	25% Contingencies	20% Engr., Admin.	Total Capital Cost
	Volume (ac-ft)	Cost	Hp	Cost	Dia./Length	Cost					
50	10,800	16.2	1,700	3.3	48"/0.5 mi.	0.82	47	8.6	19.0	15.2	110.1
100	21,650	32.5	3,300	5.9	72"/0.5 mi.	1.4	73	12.0	31.2	25.0	181.0
200	43,300	65.0	6,600	10.4	96"/0.5 mi.	2.4	111	19.1	52.0	41.6	301.5
300	64,950	97.5	9,900	13.3	108"/0.5 mi.	2.7	147	25.6	71.5	57.2	414.8
500	108,250	162.5	16,500	20.8	132"/0.5 mi.	2.8	214	36.1	109.1	87.2	632.5

Notes:

1. ENR CCI index = 5,800.
2. Environmental mitigation costs, if any, are not included in the capital costs.
3. Reallocated Reservoir Storage costs based on 120-day peak season supply with a 1.7 peak day/average peak season factor.

Table VII-11
WILLAMETTE RIVER SOURCE
ANNUAL OPERATIONS & MAINTENANCE COST SUMMARY
(in millions of dollars per year)

Maximum Day Capacity (mgd)	Reallocated Reservoir Storage O&M	Power		Chemicals	Sludge Disposal	Maintenance/Supplies		25% Contingencies	Total Annual Cost	
		Labor	Treatment Plant Pumping			Treatment Plant	Pumping			
50	0.20	0.50	1.10	0.2	0.3	0.1	0.16	0.55	0.77	3.8
100	0.35	0.75	2.00	0.3	0.5	0.2	0.23	0.85	1.30	6.5
200	0.65	1.00	4.00	0.6	1.0	0.4	0.37	1.45	2.37	11.8
300	1.00	1.00	6.10	0.9	1.5	0.6	0.48	2.00	3.40	17.0
500	1.65	1.25	10.00	1.5	2.5	1.0	0.68	2.90	5.37	26.9

Notes:

1. Power costs for the treatment plant include all ozone generation costs.
2. Power costs for pumping include those for both raw water and finished water pump stations.

The RWSP considered development of an intake facility and treatment plant on the Columbia River. The largest diversion considered in the resource strategies described in Chapter XI is 105 mgd.

The Columbia has a number of possible locations for a river intake and raw water pumping station. The most logical of these is along the river's south shore between the mouth of the Sandy River and the Portland Airport. This reach is near potential usage points, and would be less costly than locations outside this area.

Based on preliminary examination of several alternative sites, including an environmental analysis, a site just below the Sandy's mouth, currently used for gravel mining and storage, was selected as the representative site for both intake and treatment facilities. This site is shown in Figure VII-7. A raw water pump station would be integral to the intake facility due to the need to lift the supply to the treatment location.

The representative regional reservoir site for the Columbia source is on Powell Butte. (See Chapter VIII for a brief discussion of why this site was chosen.) Additional storage on Powell Butte could be accommodated with or without blending Columbia and Bull Run water.

Figure VII-7

Vicinity Map

Columbia River Site

-  River
-  Project Site
-  County
-  UGB

600 NE Grand Ave
Portland, OR 97232-2736
(503) 797-1700

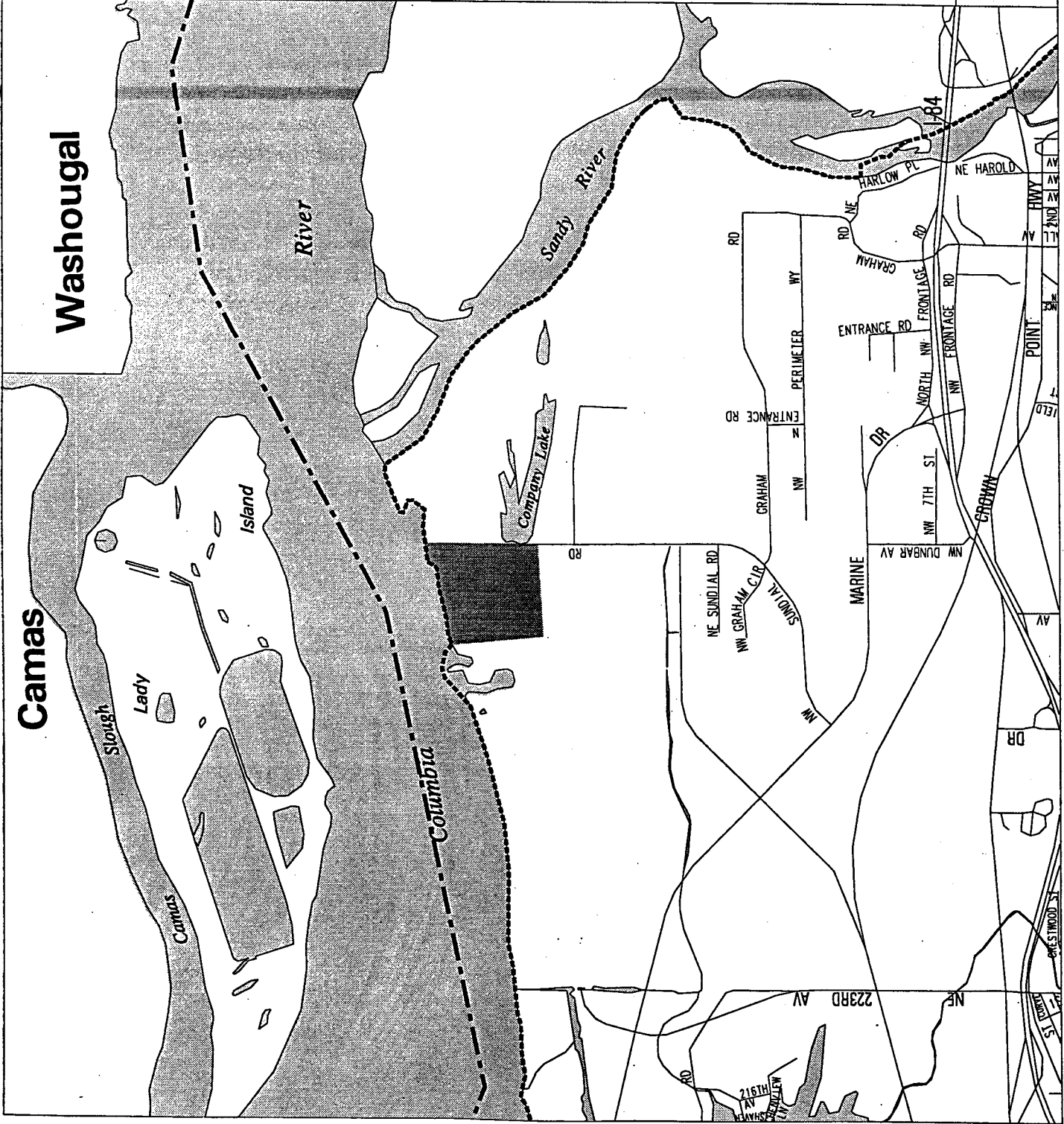

Water Availability

Average monthly flows in the Columbia River (measured at The Dalles) range from about 75,000 cubic feet per second (cfs) to about 400,000 cfs.

The Columbia River is heavily controlled by upstream storage and hydropower dam operations. The current minimum discharge required from Bonneville Dam is 70,000 cfs.

The magnitude of the flows on the Columbia dwarf the range of diversion sizes the region is considering in the RWSP. Nevertheless, future water availability may be limited by regulations designed to assist in recovery of threatened and endangered fish in the Lower Columbia Basin.

The only regional supplier that has applied for a water right on the Columbia is the Rockwood Public Utilities District, with a 50 mgd application. The application is under review by the Oregon Water Resources Department.

Environmental Impacts

The major environmental impacts of developing the Columbia source at the representative site are:

- *Fish:* Development of future water supplies on the Columbia River could affect fish populations, including listed threatened and endangered salmon stocks. However, impacts from flow reductions should be minimal as contemplated diversion levels would reduce flows by a fraction of a percent, even during low-flow months. Impacts could occur on migration of Sandy River smelt and sturgeon. A special screening design might be necessary to avoid impacts on larval fish due to slow water velocities in the Lower Columbia River.
- *Terrestrial Threatened and Endangered Species:* Two threatened, endangered, or sensitive plant and bird species have been reported on or near the representative intake and water treatment facility site. These species could be affected by construction of potential water supply facilities. The presence of Columbia cress has not been confirmed on the site, but plants could be avoided or transplanted if found there. Purple martins could be affected by construction of the water intake. The

installation of new pilings with nest boxes on the riverfront away from the site (avoiding the breeding season) would reduce the impact on the birds.

- *Wetlands:* Loss of riverine wetlands at the representative site could be mitigated by restoring disturbed areas on site or offsetting the loss of scrub and shrub emergent wetland by creating wetlands off-site.
- *Geotechnical Hazards:* The soils on and in the vicinity of the representative site could be subject to liquefaction during seismic events. Detailed seismic studies would be required to ascertain geotechnical risks and determine appropriate engineering standards.
- *Hazardous Materials:* The representative intake and facility site could be subject to contamination from off-site sources of hazardous materials. The Reynolds Metal Co. site to the southeast is currently included on the National Priority List under the Comprehensive Environmental Response, Compensation, and Liability Act (also known as "Superfund").
- *Land Use:* The representative site contains high-voltage Bonneville Power Administration (BPA) transmission lines. It may be necessary to find an alternative site for the Columbia River intake or treatment plant as current BPA regulations do not allow land grade alterations and facilities to encroach upon powerline easements.

These latter two issues deserve additional discussion. Both are quite specific to the particular representative site. They are "site-specific" rather than "source-related." Based on preliminary reconnaissance of potential sites, it is likely that, should the Columbia be chosen as a regional source, other appropriate sites will not face these unique issues. Thus, the Columbia's environmental ratings on these two issues (contained in Appendix B) have been adjusted to not penalize this source for potentially serious impacts that could be mitigated simply by relocating to an alternative site. Based on analysis to date, there appear to be a number of potentially viable sites which could be investigated further should the Columbia be chosen as a future water source for the region. Figure VII-8 illustrates some of those potential sites.

JOB No. 3434.0015 FILE No. /usr/prj/metro/wtps.dgn Plot Date/Time: 8-AUG-1995 09:35

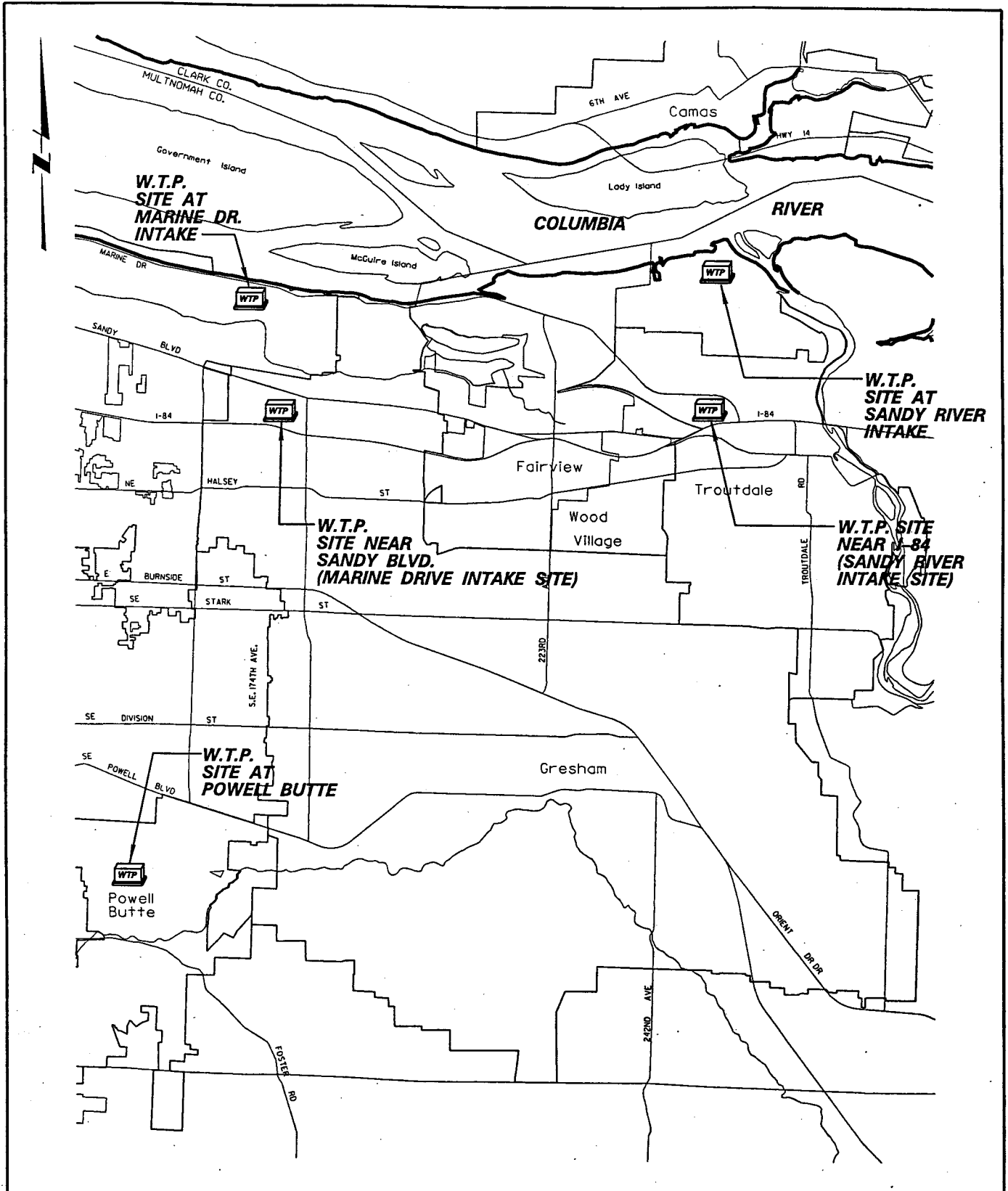

Figure VII-8
Alternative Columbia River WTP Locations
 REGIONAL WATER SUPPLY PLAN - PHASE 2

MONTGOMERY WATSON
 Portland, Oregon

SCALE: 1" = 6000'

Raw Water Quality

The Columbia River Basin encompasses about 255,000 square miles in the United States and Canada. Both the size of its basin and the diversity of its land uses pose a higher risk of pollution from municipal and industrial discharges, nonpoint sources, and possible accidental spills of toxic or hazardous chemicals relative to other sources under consideration. However, the river's large flow volumes provides significant dilution capacity for inputs to the Columbia upstream from the Portland metropolitan region.

The quality of the Columbia River water source is generally fair compared with other regional source options, and good compared with other sources nationwide. The Rockwood Public Utility District sponsored a pilot water treatment study completed in May 1994. The study stated that the Columbia River is "a source of excellent quality water, better than the majority of river sources available in the USA." The report concluded "the direct filtration process...can effectively treat the Columbia River water." This is consistent with the conclusions of the Regional Water Supply Plan (see below).

Some Columbia water quality constituents exceed drinking water standards, including turbidity, microorganisms, aluminum, iron, and a few trace organics. Measurements taken between 1984 and 1992 at the Portland airport indicate radionuclide concentrations are less than those set in federal and state drinking water standards.

Aesthetically, the water's taste is good, as monitored by upstream users. Odor-causing compounds have been noted upstream, requiring seasonal treatment. The water is also moderately hard, averaging in excess of 70 mg/l.

Although radionuclides have not been detected in significant concentrations, there is public concern about potential contamination from the Hanford facility upstream of Bonneville Dam.

Vulnerability to Catastrophic Events

A major mudflow from Mount Hood would deposit sediments in the Columbia River, especially along the south shore. Not only would an intake be vulnerable to the same major mudflows that the bridge crossings would be, it would be vulnerable to turbidity and sedimentation from smaller mudflows passing beneath existing bridges. Also, once a drainage system is disturbed by a major mudflow, it may take several years for high

sediment transport, erosion, and its channel to restabilize. For example, the Corps of Engineers spent years dredging the Toutle/Cowlitz River system after the eruption of Mount St. Helens. Several Cascade range volcanoes other than Mount Hood could generate a mudflow or diluted mudflow that could enter the Columbia River.

Although slides occur regularly in the Columbia gorge, the basin's size and dilution capacity make a significant impact on turbidity unlikely at the site of the intake. Given the size of the watershed, the range of upstream activities, and the large number of bridge crossings, the risk of a catastrophic spill is high. In addition, there are three major transportation routes up the Columbia gorge, including the river itself, that are approved for transport of hazardous materials.

Fire is not considered a major risk on the Columbia mainstem. It is a somewhat larger risk on tributaries, and might increase sediment and nutrient loadings. Increased loadings would be mitigated by the large flows in the Columbia.

Ease of Implementation

The major issues on the Columbia relate to anadromous fisheries. These issues have the potential of considerably adding to the difficulty in obtaining necessary permits to construct an intake.

Treatment Requirements

The treatment regime suggested for the Columbia source includes ozonation for disinfection, granular activated carbon (GAC) for filtration, and sedimentation basins. These processes would provide multiple barriers against microbial and organic constituents in the water, and could potentially treat particulate radionuclides. This approach to treatment would provide multiple barriers against both regulated and unregulated microbial and organic contaminants, and would provide better tasting water.

Capital and Operating Costs

Tables VII-12 and VII-13 present estimated costs for the Columbia source.

Table VII-12
COLUMBIA RIVER SOURCE
CAPITAL COST SUMMARY
(in millions of dollars)

Maximum Day Capacity (mgd)	River Intake and Raw Water Pump Station		Raw Water Pipeline		Water Treatment Plant	Finished Water Pump Sta.	25% Contingencies	20% Engr., Admin.	Total Capital Cost
	Hp	Cost	Dia./Length	Cost					
50	550	3.3	48"/0.5 mi.	0.82	54	8.8	16.7	13.4	97.0
100	1,100	6.0	72"/0.5 mi.	1.4	84	13.4	26.2	21.0	152.0
200	2,200	10.6	96"/0.5 mi.	2.4	129	21.4	40.9	32.7	236.9
400	4,400	17.0	120"/0.5 mi.	3.2	212	34.6	66.7	53.4	386.9
600	6,600	23.6	144"/0.5 mi.	4.2	283	45.6	89.1	71.3	516.8

Note:
1. ENR CCI index = 5,800.
2. Environmental mitigation costs, if any, are not included in the capital costs.

Table VII-13
COLUMBIA RIVER SOURCE
ANNUAL OPERATIONS & MAINTENANCE COST SUMMARY
(in millions of dollars per year)

Maximum Day Capacity (mgd)	Labor	Power		Chemicals	Sludge Disposal	Maintenance/Supplies		25% Contingencies	Total Annual Cost
		Pumping	Treatment Plant			Pumping	Treatment Plant		
50	0.50	1.3	0.2	0.3	0.08	0.16	0.55	0.7	3.7
100	0.75	1.9	0.3	0.5	0.15	0.25	0.85	1.2	5.9
200	1.00	3.8	0.6	0.9	0.25	0.40	1.45	2.1	10.5
400	1.25	7.7	1.2	1.8	0.50	0.67	2.4	3.9	19.5
600	1.25	11.6	1.8	2.7	0.75	0.83	3.2	5.5	27.7

Notes:

1. Power costs for the treatment plant include all ozone generation costs.
2. Power costs for pumping include those for both raw water and finished water pump stations.

Aquifer Storage and Recovery (ASR)

Description of Option

Aquifer storage and recovery (ASR) is a water management approach that stores surface water in underground aquifers (water-bearing rock strata). The water is then extracted for later use. Aquifer storage has certain advantages over surface water reservoirs. These include lower evaporation losses, potentially large storage volumes, and potentially fewer and less damaging environmental impacts. In the Portland region, ASR could help to meet peak season demands, provide emergency backup system benefits, and improve water quality by lowering temperatures in supply distribution systems during summer. Figure VII-9 provides a simple schematic representation of an ASR facility above and below ground.

Other parts of the United States use ASR, including California, Arizona, and Florida. The City of Seattle has installed and operates a 10 mgd ASR facility. In addition to providing water supply, ASR can help recharge depleted groundwater resources and prevent salt water intrusion in coastal areas.

In Oregon, ASR is being implemented in the Hermiston and St. Helens areas. A pilot project is underway to determine whether ASR development is feasible as part of the City of Salem's water supply system.

Currently, there are no ASR projects in the Portland region, but the Joint Water Commission and Tualatin Valley Water District have sponsored studies and development of an ASR project concept. The project, which would be located in Washington County, is also part of the regional water supply planning effort. The Mt. Scott Water District in Clackamas County is also conducting a study to see how ASR might meet a portion of its supply requirements.

Two representative sites were evaluated as part of the RWSP. One site is located in the Powell Valley area southeast of Gresham. The area under consideration is about 31 square miles. The Troutdale Gravel Aquifer was recommended for storage and recovery due to its relative thickness, unconfined geologic features, and unused capacity in the unsaturated zone above the water table.

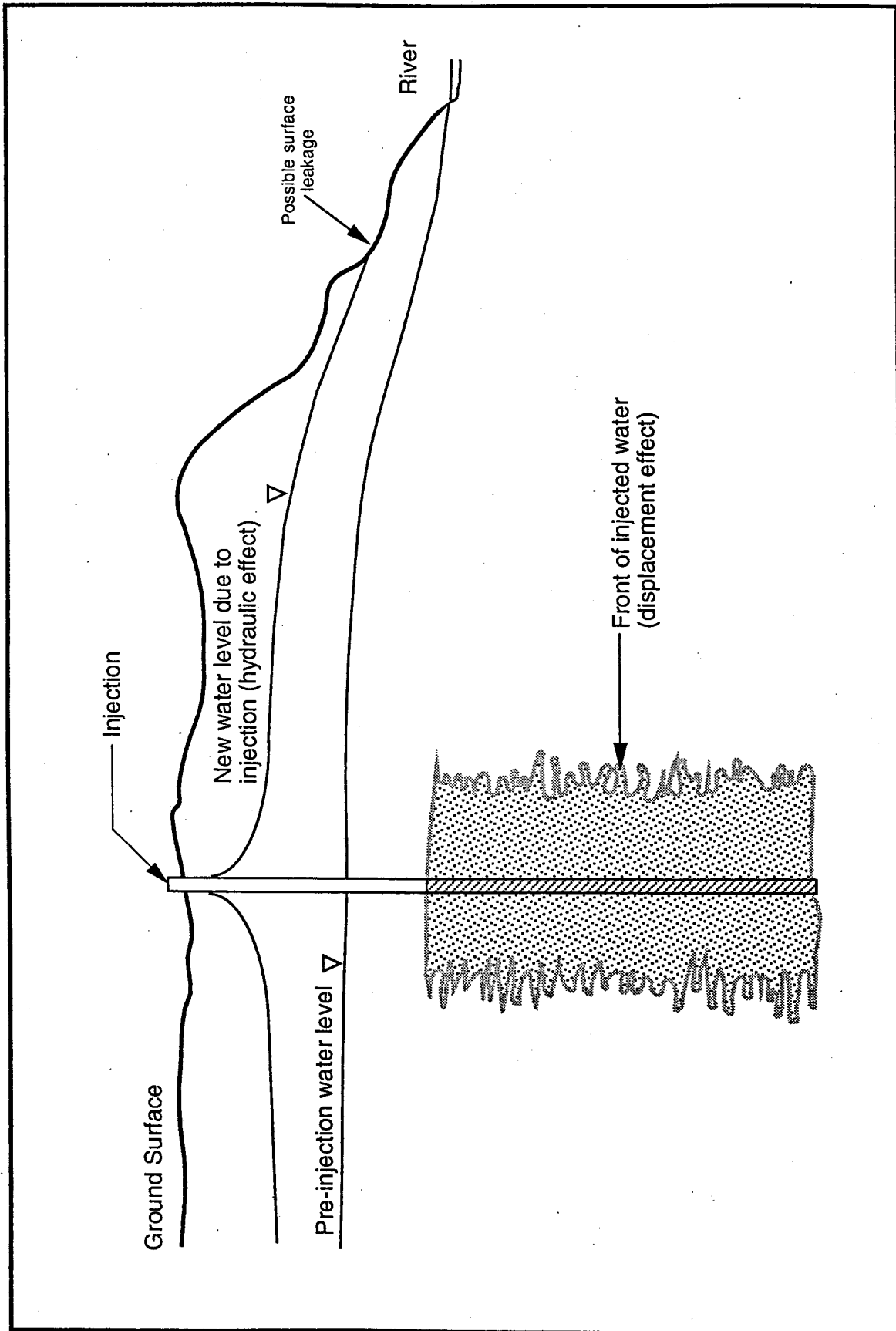

Figure VII-9

The second site under study is located in the Cooper-Bull Mountain area about four miles to the southwest of the City of Beaverton in Washington County. This site is about 24 square miles in size. Water would be stored in and extracted from the Columbia River Basalt formation. This area is close to population and economic centers in the region's western portion, and has available storage volume due to the vicinity's historical groundwater depletion.

Figure VII-10 shows the location of the Cooper-Bull Mountain and Powell Valley ASR representative sites on the west and east sides of the region, respectively.

It is estimated that the Powell Valley and Cooper-Bull Mountain ASR projects would each require 28 wells to achieve the 20 mgd seasonal yield objective (see below). Well yields would average about 500 gallons per minute (gpm). These estimates presume that the same wells could be used for both injection and extraction. Wells would need to be spaced about 4,000 feet apart to achieve the desired yield and to prevent interference. Well yields may be overestimated for the Cooper-Bull Mountain area if interconnecting multiple water bearing zones in the aquifer is prohibited by state law. Figures VII-11 and VII-12 show the conceptual configurations of the two representative ASR sites.

Figure VII-10

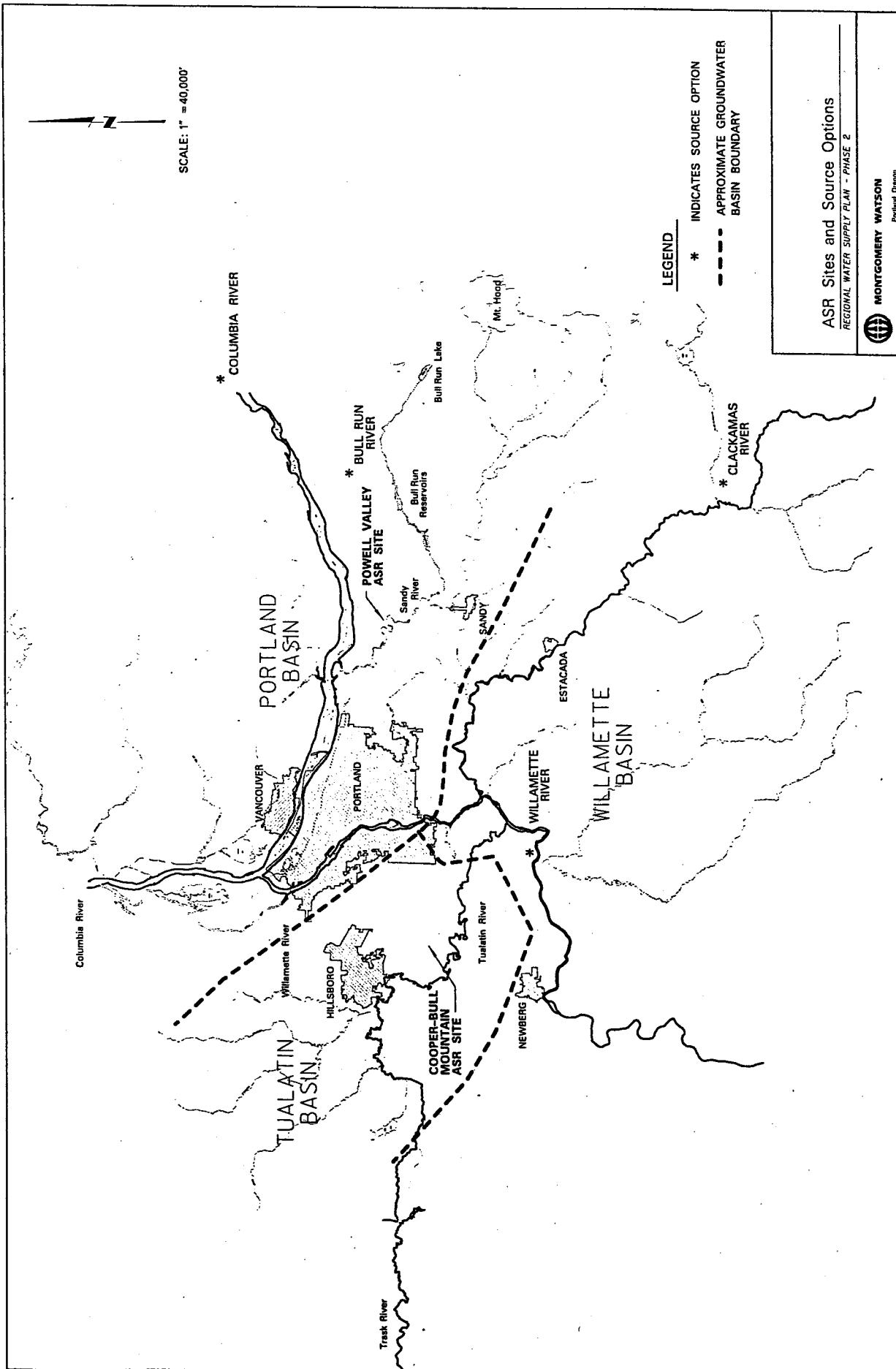

Figure VII-11

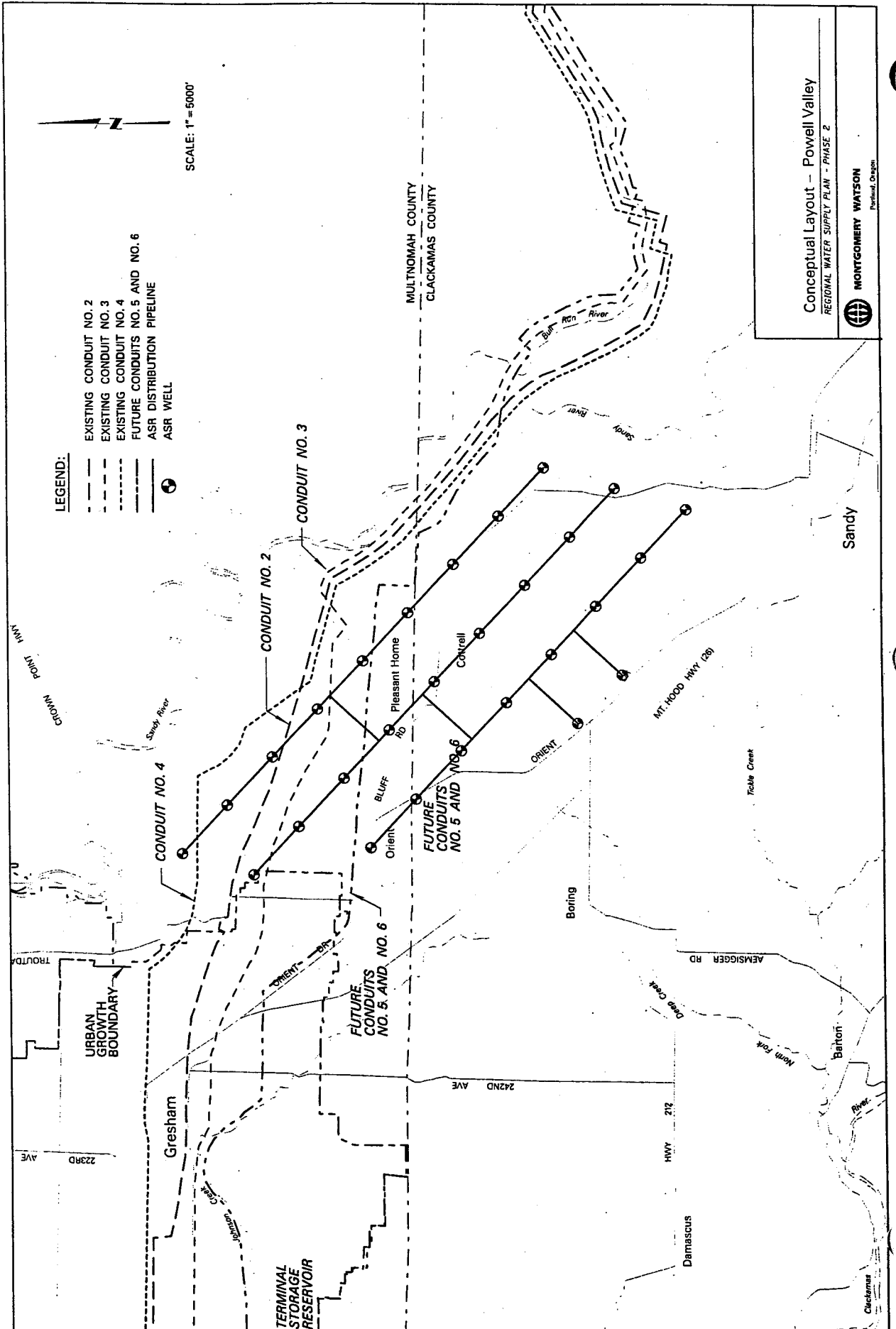
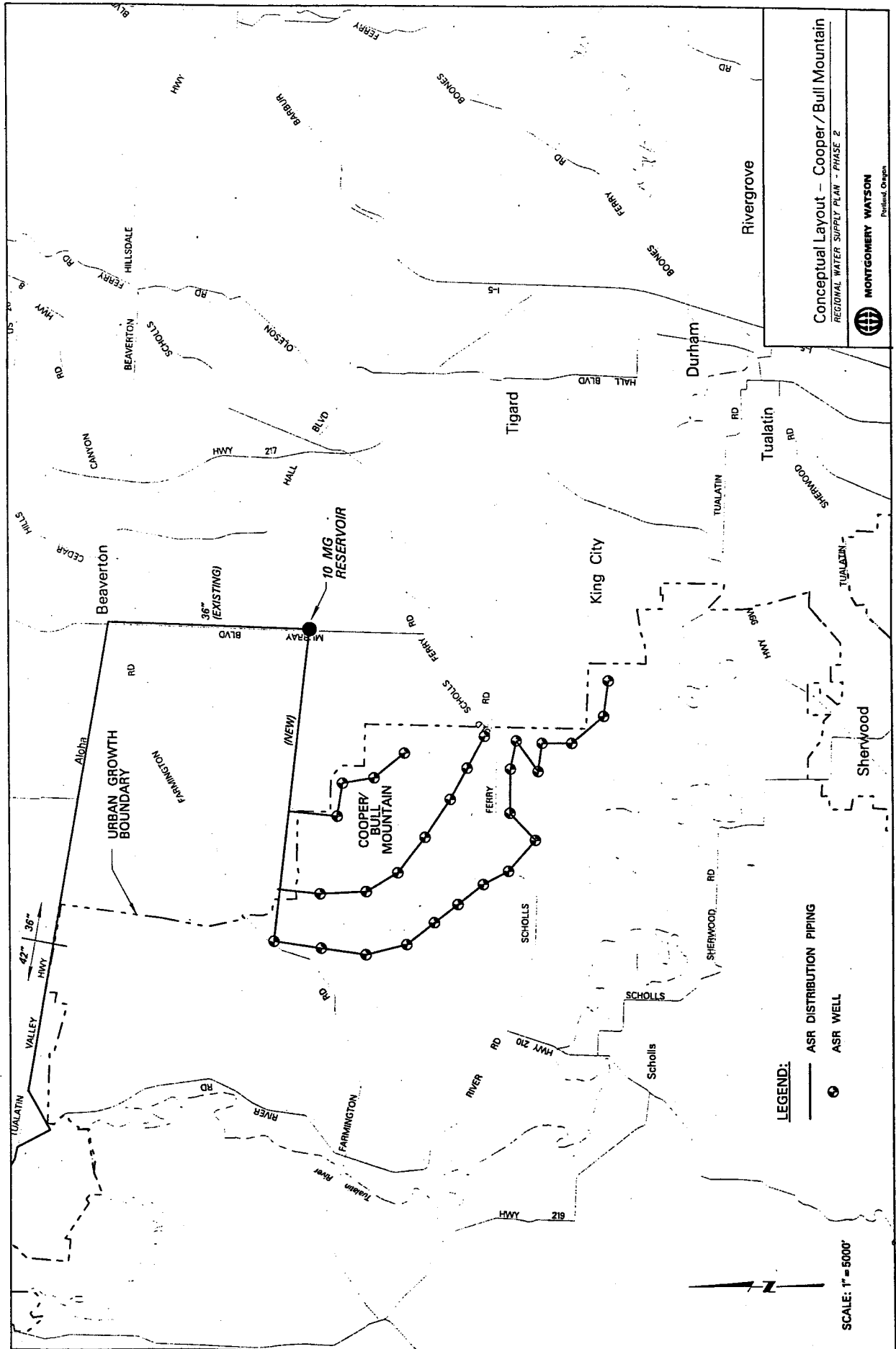

Figure VII-12



Water Availability

For purposes of the Regional Water Supply Plan project, an ASR facility would have to provide at least 20 million gallons of water per day (mgd) for 120 days, (generally during the summer and early fall) to be considered regionally significant. Limiting the evaluation to facilities of at least 20 mgd does not preclude smaller ASR projects from potentially contributing to the region's future supply.

It is also assumed that ASR surface water sources could come from any of the region's current or potential supply sources. These include the Bull Run, Clackamas, Willamette, or Columbia rivers, or the Trask/Tualatin system. Generally, surface waters would be diverted and stored underground during the high-flow months when municipal demands are relatively low and water and treatment plant capacity are available. Each of the sources, with the exception of the Columbia, could be accessed for ASR without requiring additional source water rights.

Environmental Impacts

The nature of the environmental impacts associated with ASR differ from those associated with surface sources. The key impacts are:

- *Fish and Aquatic Life:* Flow impacts on source streams would occur during the winter high-flow months when source water is diverted for injection. Implementation of ASR could reduce the need to divert surface water flows during the summer and early fall when streamflows are typically low and critical for fish and aquatic organisms. This would likely provide a net benefit to aquatic species. Potential reduction in winter flows to supply an ASR project would be very small relative to current flows in the Clackamas, Willamette, and Columbia Rivers.
- *Well Interference:* An ASR facility could potentially interfere with both existing groundwater wells and surface water bodies (including wetlands) during injection and/or extraction of source water. Interference can occur when groundwater levels and pressures change due to pumping or extraction. In addition, increasing water levels could interact with existing land uses (e.g., rock and aggregate mines), causing water quality problems. Hydrogeologic investigations and pilot tests would be needed to determine the extent of potential interference with land uses and beneficial uses of groundwater and surface water.

- *Commingling and Contamination:* Drilling wells through different water bearing zones could pose a risk of commingling water between different zones. The commingling of groundwater is prohibited by state law. There are also risks of point and non-point source contamination from surface land uses. Stringent well construction approaches and effective wellhead protection programs would be warranted to help manage such risks.

Raw Water Quality

The term “raw water quality” must be carefully defined when referring to ASR. Under current state law, source waters for ASR need to meet safe drinking water standards prior to injection. It is therefore assumed that ASR water sources in the region will have already been treated (i.e., filtered and/or disinfected) prior to injection to meet standards. The water might have to be disinfected after extraction before it can be distributed for potable uses.

The key quality issue for water extracted is its degree of potential contamination while in the ground due to any contact or commingling that might occur. No known cases of significant water quality contamination exist in either the Powell Valley or Cooper-Bull Mountain representative site areas. Both sites are located outside of the Metro urban growth boundary (UGB), which should reduce the risk of contamination from urban and industrial land uses. Nevertheless, developing a comprehensive wellhead protection program will be a high priority if aquifer storage and recovery facilities are developed.

There is little information on groundwater quality at either representative site, and more data are needed before proceeding with an ASR project. Land uses consist mostly of single-family residences with relatively large lot sizes, and along with some agricultural and nursery uses. Groundwater in the Powell Valley area may be naturally protected in part by a relatively impermeable layer of sediment at the ground surface.

Available data shows that groundwater quality is variable in the Cooper-Bull Mountain area. Several samples contained high levels of total dissolved solids which is not uncommon in groundwater sources. In addition, saline water may have migrated upward through the faults and fractures of the basalt rocks. Generally, the water quality in the upland basalt aquifers is fairly good. It may be possible to obtain groundwater samples from existing private wells to improve the information level on groundwater quality in the vicinity of the ASR representative sites.

One of the assumptions associated with the ASR concept is that there will not be extensive mixing between the source water and ambient groundwater in the aquifer. As mentioned above, the source water may come from one or more of the existing or future regional water supply sources. The raw water quality of new or expanded sources ranges from fair to excellent. Each can be treated to meet state and federal drinking water standards.

The extent and effects of interaction between the source water and the groundwater is important to consider. Changes in temperature, chemical quality, and physical characteristics may cause mineral precipitation, biological reactions, or blockages that can affect the aquifer and clog wells. While the RWSP has performed some preliminary analysis, a pilot project would be required to determine whether and to what extent problems occur, and how they can be mitigated through project siting, operation, or design.

Protecting the quality of water stored in aquifers is also an important issue. Contamination prevention can be achieved through standards for land use and land management practices in the wells' vicinity.

Vulnerability to Catastrophic Events

As ASR stores water underground and as each ASR project will be able to receive water from more than one source, ASR's vulnerability to catastrophic events is inherently smaller than that of surface water sources. This vulnerability will be further reduced with the implementation of strict wellhead protection programs. The RWSP did not examine ASR vulnerability in detail.

Ease of Implementation

A variety of implementation issues must be overcome to develop the ASR projects. The majority of these include Oregon Water Resource Department permit requirements conditions, Department of Environmental Quality permitting requirements, the critical groundwater designation for Cooper/Bull Mountain, and potential CT disinfection requirements for extracted water.

ASR has the advantage of not facing many of the difficult permitting issues associated with surface sources.

Treatment Requirements

It is assumed that all source water will be treated to meet drinking water standards prior to injection. The only potential additional treatment required for ASR water is disinfection upon extraction.

Capital and Operating Costs

Tables VII-14 and VII-15 display the estimated costs for both ASR projects. Note that these costs do not include some important components, including environmental mitigation, if necessary, and costs of wellhead protection programs.

Table VII-14
AQUIFER STORAGE AND RECOVERY
CAPITAL COST SUMMARY
(\$ millions)

Facility Element	Powell Valley Site	Cooper-Bull Mountain Site
Well Construction	1.26	2.52
Well Equipment	2.10	2.10
Distribution Piping	4.86	4.73
Electrical, Telemetry and Control	0.07	0.42
Monitoring Wells	0.16	0.32
Distribution System Connections	0.10	0.05
Chemical Feed Facilities	0.25	0.20
Land (Easements)	0.77	0.55
Preconstruction Studies and Pilot Studies	0.50	0.50
Hydrologic Feasibility Report	0.20	0.20
Project Contingencies @25%	2.57	2.90
Engr, Admin @20%	2.05	2.32
Total Capital Cost	14.89	16.81

Table VII-15
AQUIFER STORAGE AND RECOVERY
ANNUAL OPERATIONS & MAINTENANCE COST SUMMARY
(\$ per year)

Cost Element	Powell Valley Site	Cooper-Bull Mountain Site
Well Pumping Power	400,000	340,000
Chemicals for Disinfection	10,000	60,000
Labor	150,000	150,000
Maintenance and Supplies	42,000	42,000
Monitoring Well Sampling/Analysis	95,000	95,000
Cost of Treated Water Supply Source	200,000	480,000
Contingencies @ 25%	225,000	277,000
Total Annual Cost	1,122,000	1,384,000

CONCLUSION

The assessment results reported on in this Chapter are a key component of the development and assessment of future resource paths discussed in Chapter XI. The next chapter discusses another critical input to the integrated resource strategies, namely the options for enhancing the region's water transmission network.

**VIII. ANALYSIS OF REGIONAL AND SUBREGIONAL
TRANSMISSION OPTIONS**

VIII. ANALYSIS OF REGIONAL AND SUBREGIONAL TRANSMISSION OPTIONS

In addition to the source options, transmission is critical to efficiently meeting the region's needs. The regional transmission system includes several components. Chapter VII discussed and included costs for raw water pipelines that transport water from the intake or headworks to the treatment plant. This chapter discusses the remaining components, including:

- Pipelines that move treated water from the treatment plant to the regional storage reservoirs;
- The regional reservoirs themselves;
- Major "internodal" lines linking sources to demands in other parts of the region;
- Major "intranodal" lines designed to serve local demands within a demand node; and
- Local "spokes" to serve the needs of individual providers.

The transmission system must be configured to achieve a desired level of water supply reliability. (See Chapter XI for a discussion of alternative levels of reliability.) Transmission capacity can also be increased to reduce the region's vulnerability to catastrophic events. In either case, the configuration of the transmission system is integrally related to source options that currently exist, or will ultimately be developed.

It must be emphasized that the analysis reported in this chapter has been done at a planning level. Before any transmission segments can be developed, more detailed work must be performed.

REGIONAL RESERVOIRS

For each regional surface supply option (Bull Run, Clackamas, Willamette, and Columbia), it is necessary to select a representative site for a regional storage reservoir. Regional storage is needed to provide operational flexibility at proposed regional water treatment plants and to provide emergency regional storage. The sizing

of these regional storage facilities depends on the magnitude of the sources being developed. A siting analysis was performed that relied on environmental, geotechnical, operational, and hydraulic criteria. These resulted in the following representative terminal reservoir sites:

- **Bull Run and Columbia sources**
 - Existing Powell Butte reservoir site. The environmental and geotechnical review found no significant constraints for use of Powell Butte for a regional reservoir.

- **Clackamas source**
 - Forsythe Road site near the unincorporated community of Outlook in Clackamas County. The site is generally located on the topographical bench area south of Clackamas River Drive along Forsythe Road. This site is flatter than alternative sites, which presents more favorable construction conditions for a large storage reservoir. The environmental screening found this site to be acceptable.

- **Willamette source**
 - Cooper Mountain site in unincorporated Washington County west of Beaverton. Cooper Mountain rises to an approximate elevation of 760 feet. A potential storage reservoir could be located on the southwestern quadrant of the mountain. While the Cooper Mountain area contains features identified as "Natural Areas of Regional Significance," it is anticipated that the storage facility can be located away from these areas or that potential impacts can be mitigated. Cooper Mountain has the advantage of being located in a direct alignment between the Willamette source representative site and the major demand centers in Washington County.

MAJOR TRANSMISSION CORRIDORS

A variety of design criteria were developed to guide the analysis of transmission pipelines. Key criteria include:

- Pipeline size
- Pipeline flow velocities and roughness coefficient
- Pipeline materials
- Reservoir storage
- Hydraulic gradients

In particular, transmission main sizing criteria are based on pipeline friction losses of 1 foot per 1,000 feet using a Hazen-Williams roughness coefficient (C-factor) of 130. Table VIII-1 reviews the correlation of pipeline capacities and pipeline sizes at this headloss.

**Table VIII-1
PIPELINE CAPACITY AND DIAMETER SUMMARY**

Pipeline Capacity (Million Gallons Per Day)	Pipeline Diameter (Inches)
0.9	12
1.8	16
2.5	18
3.3	20
5	24
10	30
15	36
25	42
35	48
45	54
60	60
75	66
95	72
145	84
200	96
280	108
365	120
470	132
590	144

The regional transmission facilities are intended to serve as supply conduits between the demand nodes, and to supply local transmission facilities at connection points along the corridor. They also function as subregional transmission mains as necessary.

Nine major corridors were identified. Representative corridor alignments were developed to connect representative source option and reservoir sites. The representative corridors were developed to allow final alignment selection within corridors approximately 4,000 feet wide. This width provides flexibility in final alignment selection, and allows environmental, land use, and geotechnical features to be identified within the corridors. It is anticipated that final transmission main alignments will follow existing developed rights of way where possible. Transmission main corridor alignments must be selected so positive hydraulic pressure is always maintained within the transmission facilities. For this analysis, transmission corridors were selected with a maximum elevation of approximately 450 feet. It should be noted that the existing Washington County Supply Line has a high point of approximately 480 feet.

Each proposed regional transmission corridor was evaluated and screened for the same environmental, land use, and geotechnical factors used to evaluate regional storage facilities. These evaluations identified river and stream crossings as areas of most significant concern. The review found no significant constraints that would affect the construction of major transmission facilities in the described corridors.

A discussion of each regional transmission corridor follows. Where alternate alignments are presented, each is discussed, and a preferred alignment is selected.

Lusted Hill/Powell Butte Corridor

The Lusted Hill/Powell Butte transmission corridor connects the Lusted Hill treatment plant site to a regional storage reservoir at Powell Butte. The total length of this corridor is approximately 65,000 feet. The corridor begins at the representative water treatment plant site at Lusted Hill and follows a westerly alignment generally south of the existing Bull Run conduits to Powell Butte. It is anticipated that no providers will connect local transmission mains to regional facilities along this corridor.

Columbia River/Powell Butte Corridor

The Columbia River/Powell Butte transmission corridor connects the Columbia River source option to a regional storage reservoir on Powell Butte. The total length of the corridor is approximately 55,000 feet. The corridor begins at the representative water treatment plant site near the confluence of the Sandy and Columbia Rivers, then turns south through Troutdale, west between NE Halsey Street and E Burnside Street, south

between SE 182nd Avenue to SE Powell Boulevard, and west along SE Powell Boulevard to Powell Butte. It is anticipated that providers able to connect local transmission mains to regional facilities along this corridor include:

- City of Fairview
- City of Troutdale
- City of Wood Village

Powell Butte/Clackamas River Corridor

The Powell Butte/Clackamas corridor connects a regional storage reservoir at Powell Butte to the representative site for the consolidated Clackamas River source option treatment facilities. The total length of the corridor is approximately 55,000 feet. The corridor begins at the representative water treatment plant site in Clackamas, then turns easterly along Highway 212/224 to Sieben Lane, north along Sieben Lane to SE Sunnyside Road, east on Sunnyside Road to Rock Creek Road, north on Rock Creek Road to SE Foster Road, and north along SE Foster Road to Powell Butte. It is anticipated that providers able to connect local transmission mains to regional facilities along this corridor include:

- Damascus Water District
- Mount Scott Water District
- City of Milwaukie
- Clackamas River Water
- South Fork Water Board

Powell Butte/Beaverton Corridor

The Powell Butte/Beaverton corridor connects a regional storage reservoir at Powell Butte to the northern end of the Tualatin/Beaverton corridor and to the eastern end of the Cooper Mountain/Beaverton Corridor. The corridor's total length is approximately 75,000 feet. The corridor begins near the intersection of SW Denny Road and SW Hall Boulevard, turns east through the West Hills of Portland, continues generally east along SW Multnomah Boulevard to the intersection of SW Terwilliger Road and SW Taylors Ferry Road, to a crossing of the Willamette River near the Sellwood Bridge, and generally east through southeast Portland to Powell Butte. It is anticipated that providers will not connect local transmission mains to regional facilities along this corridor.

Clackamas/Tualatin Corridor

Two alignments were evaluated for the transmission corridor connecting Clackamas to Washington County systems. These are the Clackamas/Tualatin Corridor Alternatives A and B. The Clackamas/Tualatin Corridor Alternative A connects the Clackamas River source option to the southern end of the Tualatin/Beaverton corridor near the City of Durham, north of the Tualatin River. The total length of this corridor is approximately 60,000 feet. From the representative site of the Clackamas River treatment facilities, the corridor extends west, crossing the Willamette River north of Gladstone near Mary S. Young State Park in West Linn, then angles north along the west bank of the Willamette River to Lake Oswego, west through Lake Oswego along Country Club Road to Boones Ferry Road, and west to Durham.

The Clackamas/Tualatin Corridor Alternative B also connects the Clackamas River source option to the southern end of the Tualatin/Beaverton corridor near the City of Durham. From the representative site of the Clackamas River treatment facilities, the corridor extends west to Gladstone, then heads south, crossing the Clackamas River near Gladstone and the Willamette River in the general vicinity of Oregon City or West Linn. From West Linn the transmission corridor extends west, generally paralleling the I-205 Freeway, crossing the Tualatin River near SW Stafford Road, and connecting to the southern end of the Tualatin/Beaverton corridor near the City of Durham. The total length of this corridor is approximately 70,000 feet.

Preliminary costs were developed for the Clackamas/Tualatin Corridor alternatives. Based on these estimates, the cost of Alternative B was approximately 10% to 20% higher for all pipe sizes. Alternative B was screened out in favor of further consideration of Alternative A.

It is anticipated that providers able to connect local transmission mains to regional facilities along this corridor include:

- Oak Lodge Water District
- City of Gladstone

Clackamas/Forsythe Road Corridor

The Clackamas/Forsythe Road corridor connects the Clackamas River source option treatment facilities to a regional storage facility on Forsythe Road. The total length of

this corridor is approximately 16,000 feet. The corridor begins north of the Clackamas River at the Clackamas River source option representative treatment plant site and crosses the Clackamas River west of the treatment plant site, extending south to Forsythe Road, then east to the representative reservoir site. It is anticipated providers will not connect local transmission mains to regional facilities along this corridor.

Willamette/Tualatin Corridor

The Willamette/Tualatin Corridor connects the Willamette River source option treatment facility at the representative site in Wilsonville to proposed transmission facilities at the City of Durham. The total length of this corridor is approximately 36,000 feet. The corridor begins at the treatment facility of the Willamette River source option and ends near the City of Durham, north of the Tualatin River. It is anticipated that the providers able to connect local transmission mains to regional facilities along this corridor include:

- Canby Utility Board
- City of Wilsonville
- City of Sherwood
- City of Tualatin

Tualatin/Beaverton Corridor

The Tualatin/Beaverton Corridor serves as a link between the Willamette/Tualatin Corridor, the Clackamas/Tualatin Corridor, the Powell Butte/Beaverton Corridor and the Cooper Mountain/Beaverton Corridor. The total length of this corridor is approximately 35,000 feet. The corridor follows a general alignment of SW Hall Boulevard from south of Tigard, north into Beaverton. Local transmission mains and connections associated with this corridor are:

- City of Tigard
- City of Lake Oswego
- Tualatin Valley Water District
- City of Hillsboro

Cooper Mountain/Beaverton Corridor

The Cooper Mountain/Beaverton Corridor connects the Powell Butte/Beaverton Corridor and the Beaverton/Tualatin Corridor to the representative reservoir site at Cooper Mountain. The total length of the corridor is approximately 30,000 feet. It is anticipated that providers will not connect local transmission mains to regional facilities along this corridor.

The timing of required additions of these major lines is related to the configuration and timing of the supply additions.

LOCAL TRANSMISSION

The final components of the transmission system are “spokes” that deliver water to the local providers from one of the major transmission lines. For each provider, these spokes were sized to meet the projected 2050 demand deficit based on forecasted high peak-day demands.¹³ The actual progression of local transmission additions in the intervening years must be addressed within the context of implementing the adopted long-term regional strategy.

Table VIII-2 shows projected demand deficits, delivery points, and line sizings required for each provider.

¹³The demand estimates used to size the “spokes” are based on peak-day demand forecasts that were developed in February 1995. That forecast was subsequently updated to result in somewhat higher peak-day demands. This may result in minor increases in the base cost estimates of the local transmission facilities. The overall impact of these increases will be insignificant relative to total regional supply and transmission costs.

Table VIII-2 (page 1 of 4)
LOCAL DELIVERY SYSTEM SUMMARY

Name	Existing Source or Peak Day Capacity (mgd)	Demand Node	2050 Demand (mgd) Peak Day High	Demand Deficit Including Existing Wells (mgd)	Demand Deficit Excluding Existing Wells (mgd)	Terminal Facility Connection or Service Level	Proposed Local Trans. Main Size (inches)
CLACKAMAS COUNTY							
Canby Utility Board	6.0	West	9.3	-	3.3	Water Treatment Plant	20
Clackamas Water District(7)*	20.0	South	26.0	-	6.0	Mather Road Reservoir	24
City of Gladstone(7)	3.0	South	4.7	-	1.7	Webster Rd Reservoir	16
Mount Scott Water District(1)	7.0	South	11.8	-	4.8	New 3.0 mg Reservoir	24
SUBTOTAL	30.0		42.5		12.5		
Oak Lodge Water District(7)	8.5	South	11.3	-	2.8	Valley View Reservoirs	18
City of Lake Oswego(5)(8)	20.0	West	22.9	-	2.9	Waluga Reservoir	18
City of Milwaukie (3)	6.7	South	11.8	5.1	11.8	Reservoir No. 2	30
City of Estacada(17)(20)	1.0	South	1.6	-	0.6	-	-
South Fork Water Board(8)							
City of Oregon City(6)	8.4	South	8.4	-	0.0	SFWB WTP Clearwell	-
City of West Linn(6)	9.4	South	9.4	-	0.0	SFWB WTP Clearwell	-
Clairmont Water District(6)	12.2	South	18.3	-	6.1	SFWB WTP Clearwell	-
SUBTOTAL	30.0		36.1		6.1		24
City of Wilsonville(3)	3.6	West	16.6	13.0	16.6	Main Reservoirs	36
City of Sandy(4)(21)	2.5	East	4.5	-	2.0	Vista Loop Reservoir	54
Damascus Water District(3)	3.7	East	42.1	38.4	42.1	Sunnyside Reservoir	54

All numbers in parentheses refer to footnotes. See page 4 of Table VIII-2 for footnote descriptions.

Table VIII-2 (page 2 of 4)
LOCAL DELIVERY SYSTEM SUMMARY

Name	Existing Source or Peak Day Capacity (mgd)	Demand Node	2050 Demand (mgd) Peak Day High	Demand Deficit - Including Existing Wells (mgd)	Demand Deficit - Excluding Existing Wells (mgd)	Terminal Facility Connection or Service Level	Proposed Local Trans. Main Size (inches)
MULTNOMAH COUNTY							
City of Fairview(3)*	1.9	East	13.8	11.9	13.8	Main Reservoir	30
City of Gresham(15)	30.0	East	30.0	-	0.0	Reservoir No. 4	(9)
City of Portland(16)(18)	159.6	East	193.0	-	33.4	Powell Butte Reservoir	(9)
City of Troutdale(3)	8.0	East	13.9	5.9	13.9	Reservoirs No. 3 and 4	30
City of Wood Village(3)	1.4	East	1.4	0.0	1.4	Main Reservoir	16
Powell Valley Road Water District(3)	7.7	East	7.7	-	0.0	Main Reservoirs	(9)
Rockwood Water People's Utility District(15)(14)	20.0	East	19.3	-	0.0	Powell Butte Reservoir	(9)
City of Boring(3)(17)(19)	1.0	East	1.0	0.0	1.0	Existing Conduit Connection	(9)
GNR/GV/SA (2)(15)(17)	0.1	East	0.1	-	0.0	Existing Conduit Connection	(9)
Lusted Water District(15)(17)	0.3	East	0.3	-	0.0	Existing Conduit Connection	(9)
Interlachen Water District(3)(17)	0.2	East	0.2	0.0	0.2	Existing Conduit Connection	(9)
Pleasant Home Water District(15)(17)	0.5	East	0.5	-	0.0	Existing Conduit Connection	(9)
Loma Water District(15)(17)	0.1	East	0.1	-	0.0	Existing Conduit Connection	(9)
Hideaway Hills Water District(15)(17)	0.0	East	0.0	-	0.0	Existing Conduit Connection	(9)

All numbers in parentheses refer to footnotes. See page 4 of Table VIII-2 for footnote descriptions.

**Table VIII-2 (page 3 of 4)
LOCAL DELIVERY SYSTEM SUMMARY**

Name	Existing Source or Peak Day Capacity (mgd)	Demand Node	2050 Demand Peak Day High (mgd)	Demand Deficit - Including Existing Wells (mgd)	Demand Deficit - Excluding Existing Wells (mgd)	Terminal Facility Connection or Service Level	Proposed Local Trans. Main Size (inches)
WASHINGTON COUNTY							
City of Beaverton(12)(13)*	18.0	West	17.1	-	0.0	Sexton Mountain Reservoirs	(9)
City of Forest Grove(12)	7.3	West	11.2	-	3.9	WTP Reservoir	(9)
City of Hillsboro(12)(22)	27.5	West	58.6	-	31.1	Main Service Level	48
City of Sherwood(3)	2.8	West	12.5	9.7	12.5	Main Reservoir	30
City of Tigard	0.0	West	22.1	-	22.1	410-foot Service Level	36
City of Tualatin(10)	6.0	West	9.9	-	3.9	Service Level B	24
Raleigh Water District(10)	1.2	West	1.3	-	0.1	Main Service Level	(9)
Tualatin Valley Water District(10)(11)(12)(22)	63.8	West	93.1	-	29.3	435-foot Service Level	72
West Slope Water District	3.7	East	3.7	-	0.0	Main Reservoirs	(9)
City of Cornelius(17)	2.6	West	4.2	-	1.6	Hillsboro's System	(9)
City of North Plains(3)(17)	0.6	West	0.6	0.0	0.6	Hillsboro's System	(9)
City of Gaston(17)	0.9	West	0.9	-	0.0	Haines Falls Supply Line	(9)

All numbers in parentheses refer to footnotes. See page 4 of Table VIII-2 for footnote descriptions.

**Table VIII-2 (page 4 of 4)
LOCAL DELIVERY SYSTEM SUMMARY**

Footnote Descriptions

- (1) Oak Lodge Water District WTP in service by late 1996 with a design capacity of 8.5 mgd.
- (2) GNR Corp/Green Valley/Skyview Acres.
- (3) Existing ground water well source.
- (4) Sandy's supply capacity is approximately 2.5 mgd following the WTP expansion, scheduled for completion in late 1995.
- (5) The Lake Oswego demand estimate includes the Rivergrove, Lake Grove, Glenn Morie, Mossy Brae, Skylands, and Southwood Park Water Districts.
- (6) Existing peak day capacities apportioned based on 1989 South Fork Water Board (SFWB) Water Master Plan Demand Data.
- (7) Existing peak day capacities apportioned based on existing estimated peak day use from Clackamas Water District WTP.
Existing Oak Lodge WD capacity included as part of Clackamas WD capacity.
- (8) Existing source capacity assumptions based on Task 7 "Base Capacities".
- (9) Capacity of existing transmission facilities adequate to meet estimated 2050 demands.
- (10) Existing supply through the Washington County Supply Line (WCSL) from the Powell Butte Reservoir.
- (11) Tualatin Valley WD's existing capacity includes 52.8 mgd through the WCSL and 11 mgd from the Joint Water Commission (JWC).
- (12) Existing source capacity includes JWC WTP expansion to 60 mgd.
- (13) Additional transmission capacity from Fern Hill Reservoir is to be provided with JWC expansion.
- (14) Rockwood Water's year 2050 peak day demand includes 40% (0.69 mgd) of Hazelwood WD's 2050 peak day demand estimate.
- (15) Existing supply from City of Portland conduit connections Existing connection capacities adequate to meet estimated 2050 demands.
- (16) Estimated year 2050 peak day demand includes 189.9 mgd, Portland; 1.3 mgd, Palatine Hill WD; 0.4 mgd, Valley View WD; 0.1 mgd, Burlington WD; 1.04 mgd, 60% of Hazelwood WD's estimated 2050 demand.
- (17) Provider not included in Task 1 inventory of existing systems.
- (18) City of Portland's existing supply capacity equals the conduits' supply capacity of 210 mgd plus 72 mgd from the ground water wells minus the following: 60 mgd, WCSL; 3.7 mgd, West Slope WD; 7.7 mgd, Powell Valley Road WD; 30 mgd, Gresham; 20 mgd, Rockwood Water PUD; and 1.01 mgd for GNR/GV/SA, Lusted WD, Pleasant Home WD, Lorna WD and Hideaway Hills WD.
- (19) Existing capacity of ground water wells is approximately 2.8 mgd.
- (20) Estacada plans to expand its existing Clackamas River supply to meet estimated year 2050 demands.
- (21) Long range source supplies for Sandy include the ultimate development of a Salmon River source.
- (22) Hillsboro and the Tualatin Valley Water District local transmission mains include a shared segment of proposed 66-inch diameter main from the

COST ESTIMATES

Cost curves were developed for each reservoir and transmission corridor. The curves represent the cost of the representative facilities for variable flow rates and include fixed costs for those local transmission mains connecting the corridor to local delivery systems along the corridor.

The estimates are considered planning level estimates, and may vary by plus 50% and minus 30%. The costs are based on March 1995 dollars, corresponding to a Seattle ENR Construction Cost Index of 5,794.

All the estimated costs are project costs that include a 25% allowance for contingencies and 20% for administration, engineering, and construction management.

Reservoirs

The project costs developed for regional storage reservoirs cover total storage volumes up to approximately 250 mg. It is assumed that the maximum size of a single storage reservoir will be 50 mg. Multiple reservoirs are assumed for total storage capacities above 50 mg. Property acquisition costs have been included in the development of individual cost curves for the Forsythe Road and Cooper Mountain Reservoirs. No property acquisition allowance has been added for the Powell Butte Reservoir since the Powell Butte site is already owned by the City of Portland. Annual O&M costs for reservoirs have been assumed to be 1.5% of capital costs.

Transmission Mains

The project cost curves developed for the regional and local transmission facilities include the following components:

- (1) *Excavation and backfill.* Allowances for rock excavation were included for areas identified in the geotechnical evaluation as containing subsurface rock formations.
- (2) *Pipe materials and installation.* This included an allowance for cathodic protection. Inline valves have been included every 10,000 feet. For transmission mains up to 48-inches in diameter, valves are direct buried. Cost estimates for larger valves include provisions for buried valve vaults.

- (3) *Surface restoration for alignments on improved streets.*
- (4) *Major river crossings.* Major river crossings have trapezoidal trench profiles and are capped with rip rap. It is assumed both ends of the crossing will be provided with vaults containing isolation valves. All river crossings are planned to be in areas where the river bottom conditions allow trenching without underwater rock excavation.
- (5) *A specialty construction allowance.* This specialty construction allowance covers areas requiring special construction techniques such as railroad crossings, creek crossings, pipeline piers, or other conditions. The identification of areas in need of special construction techniques was performed at a reconnaissance grade planning level. Detailed examination of specific alignment construction needs was not performed.
- (6) *Relocation of utilities.* For transmission mains up to 42 inches in diameter, it is anticipated construction of transmission facilities can be accomplished without relocating existing utilities. Estimated project costs for transmission mains 48-inches in diameter and greater include provisions for necessary utility relocation.
- (7) *Interties.* Two types of system intertie costs are included in the estimates. These are major interties and local delivery system connections. Major interties are provided, anticipating that future regional transmission facilities will be intertied into existing supply and transmission facilities at certain points throughout the region. Major interties include provisions for connection piping and valving. Local delivery system connections are provided with isolation valving and flow metering facilities. These costs are additive to the costs of local transmission piping connecting local delivery systems to regional supply facilities.

The cost estimates developed for each transmission system and local transmission main were developed based on a planning level review of potential alignments, determining the appropriate lengths, number of potential river crossings, areas of potential rock excavation, and areas of specialty construction. Annual O&M costs for transmission mains are approximately 1.5% of capital costs.

Local Delivery Systems

Unlike major lines and terminal reservoirs, costs of local mains are treated as fixed. They are included as base costs in the major transmission corridor cost curves. For any particular major transmission link, several cost curves are developed to correspond to different assumptions about which local delivery costs are included. This is necessary to ensure that appropriate local delivery costs are included once and only once in resource sequences that include development of different transmission corridors at different times.

CONCLUSION

The development of regional, subregional, and local transmission options will be a challenge to the regional providers if these options are to meet local needs over the entire planning period in a way consistent with the region's anticipated ultimate supply sources. At times, total consistency will not be possible. It can be expected that the immediacy of particular local providers' needs will sometimes result in a less-than-optimal transmission development path when viewed from a regional perspective. This friction between short-term local needs and long-term regional needs is not surprising. Its resolution must recognize that a regional plan that cannot flexibly meet the ongoing needs of the participant providers will not retain the critical support of those providers. However, these needs should be met in the context of the strategic direction the region has chosen. All decisions on transmission additions over the planning period must be viewed in that light.

IX. ANALYSIS OF CONSERVATION OPTIONS

IX. ANALYSIS OF CONSERVATION OPTIONS

A basic premise of the RWSP is that water conservation is a resource that can play a key role in meeting future water needs. This resource was carefully considered and subjected to the same level of analysis as are supply sources. The RWSP used a comprehensive framework to examine water conservation to assure that all viable conservation technologies and management practices are considered.

Note that the programmatic conservation discussed in this chapter is in addition to the “naturally occurring” conservation embedded in the base demand forecast described in Chapter V. Naturally occurring conservation results from market, code and legislative changes and will occur regardless of actions by water providers. The conservation programs described in this chapter would augment the water savings associated with naturally occurring conservation.

Descriptions follow of steps taken in analyzing conservation options.

THE UNIVERSE OF CONSERVATION MEASURES

A conservation *measure* is defined as a water saving technology or management practice. Examples include low-flow showerheads, water-efficient landscaping, more efficient irrigation practices, and industrial cooling tower modifications. The first step in the conservation plan was to develop a comprehensive list of some 150 measures. The list was developed from conservation literature, reports from other water utilities, and project team knowledge and experience with conservation program planning and implementation. The list includes indoor and outdoor measures for residential, commercial, industrial, and institutional customers and represents the universe of measures that the region should consider.

SCREENING OF CONSERVATION MEASURES

Each of the measures was subjected to two screens designed to narrow the list to those with potential applicability to the region. These screens were intentionally permissive to minimize the chance of prematurely excluding measures of value. The measures were first screened qualitatively. Profiles were developed for the remaining measures, which then were screened for economic viability.

The Qualitative Screen

The qualitative screen was designed to:

- Identify specific qualitative factors or criteria that would limit the applicability of measures in the region; and
- *Only* eliminate those measures that are clearly inappropriate for the goals and conditions of the regional suppliers.

The screening criteria applied were as follows:

- ***Better measure available:*** Another, clearly more appropriate, measure exists that addresses a specific inefficiency in water use. For example, low-flow faucets were screened out in favor of faucet aerators in retrofit situations because aerators are less expensive and easier to install than low-flow faucets, though both are equally effective.
- ***Technological/market maturity:*** The technology is not commercially available or not supported by the necessary service industry. For example, 1-quart flush toilets were eliminated because they are not yet commercially available in the United States. Similarly, ultrasonic dishwashers were screened out because there are few manufacturers in this country, and the technology has not been adequately tested for commercial applications. Measures that currently do not have an adequate level of technological or market maturity may attain such maturity in the future, and the providers should therefore reexamine these measures in plan updates.
- ***Poor regional match:*** The technology is not applicable to the climate, building stock, or equipment typical in the region. Alternatively, the measures may not be feasible for providers to administer because of their limited application. For example, swimming pool covers for residential application have been eliminated from further consideration because of the negligible number of residential pools in the region. In addition, water-efficient medical and laboratory equipment were eliminated because of their limited applicability.
- ***Poor customer acceptance:*** Customers will be so unwilling to implement the measure that penetration rates will be unacceptably low or customer

incentives will be too costly. For example, all-weather artificial surfaces were eliminated because they were considered to be aesthetically unacceptable to customers.

- ***Environmental and health concerns:*** The measure raises unacceptable concerns regarding health, safety, or environmental impacts. For example, gray water systems were screened out for commercial and industrial applications because of potential health and safety problems.

To facilitate the qualitative screening process, the plan combined industrial conservation measures targeting similar end-uses. For example, measures aimed at reducing cooling tower water use, such as drift eliminators and conductivity meters for blow-down control, were combined and screened as a single measure—cooling tower modifications.

The qualitative screening results for indoor measures are presented in Table IX-1; the results for the outdoor measures are presented in Table IX-2.¹⁴

¹⁴Note that these tables include substantially fewer than 150 measures in total. The 150 measures distinguish among different applications for each technology or management practice. For economic screening purposes (see below), These distinctions are important. For example, an ultra low flush toilet might replace a 5.5 gallon per flush toilet or a 3.5 gallon per flush toilet. Further, it could replace a toilet that would have been replaced in any case, or a toilet that is only being replaced to achieve increased water efficiency. Each of these cases is considered a separate measure for economic screening purposes.

TABLE IX-1
INDOOR CONSERVATION MEASURE
QUALITATIVE SCREENING RESULTS

RESIDENTIAL - PASSING
Low-flow showerhead (2.5 gallon/minute)
Ultra low-flow showerhead (1.3 gallon/minute)
Faucet aerators
Leaking faucet repair
Gravity flow ultra low-flush toilets (1.6 gallon/flush)
Pressurized tank-type ultra low-flush toilets (1.6 gallon/flush)
<i>Toilet Tank Devices:</i>
Displacement bags
Fill-cycle regulators
Early closure flapper valve
Toilet leak detection & repair
Horizontal axis clothes washer
High-efficiency residential dishwasher

CI&I - PASSING
Valve-type ultra low-flush toilet (1.6 gallon/flush)
Pressurized tank-type ultra low-flush toilet (1.6 gallon/flush)
Valve retrofit on valve-type toilet (1.6 gallon/flush valve)
Valve retrofit on urinal
<i>Commercial Faucet Measures:</i>
Manual low-flow faucet
Pressure-closing faucet
Foot-pedal operated faucet
Infrared activated faucet
Ultrasonic activated faucet or ultrasonic device
Spring-loaded faucet (with aerator)
Commercial horizontal axis clothes washer
Commercial recycling dishwasher
<i>Commercial HVAC measures:</i>
Purchase new air-cooled unitary system
Purchase new air-cooled chiller
Purchase new air-cooled air conditioner
Purchase closed-loop air conditioning system
Early retirement of single pass cooling system; install closed-loop system
Improve O&M practices for water-cooled condenser
Ozonation of cooling tower water
Improve O&M practices of evaporative coolers
Steam condensate return system heat exchanger
Air-cooled pumps and compressors
<i>Commercial Miscellaneous</i>
Air-cooled ice-makers
Air-cooled drinking fountains (16 gallons/hour)
Individual business submeters
<i>Industrial Miscellaneous</i>
HVAC measures (see above)
Improve industrial washers and rinsers
Install solenoid and automatic control valves
Evaluate water recycling
Evaluate waste stream separation
Install sub-meters for irrigation
Water distribution system leak detection

TABLE IX-1
INDOOR CONSERVATION MEASURE
QUALITATIVE SCREENING RESULTS
 (page 2 of 2)

RESIDENTIAL - FAILING

Shower-flow restrictors (Low-flow showerheads are a better measure.)
 Toilet displacement bottles (Bottles too bulky for delivery; bags are a better measure.)
 Toilet displacement dams (Dams too bulky for delivery; bags are a better measure.)
 Replace self-generating water softeners (Water in region already soft.)
 Point-of-use water heaters (Limited capacity; not adequate for multiple uses.)
 Recirculating hot water system (Wastes energy; redundant with current practices.)
 Individual dwelling unit submeters (Better measure available; poor utility match.)
 Separate irrigation submeters (Better measure available; poor utility match.)
 Metering all accounts (All participating water providers have implemented.)
 Water pressure regulator (Average water pressure in region is less than 80 psi.)

CI&I FAILING

Infrared-activated toilet flushing (Does not save water; implemented for sanitary reasons.)
 Point-of-use water heaters (Limited capacity; not adequate for multiple uses.)
 Recirculating hot water system (Wastes energy; redundant with current practices.)
 Water softeners - centralized regeneration (Water in region already soft)
 Water softeners - meter-controlled flushing (Water in region already soft)
 Ozonated clothes washers (Few eligible customers in the Portland region.)
 Air-cooled medical and laboratory equipment (Overall water use of this end-use is small.)
 Chemical sanitizer dishwashers (Potential problems due to bleach handling.)
 Conveyor belt dishwashers (Not interchangeable with door-type; capacities differ.)
 Ultra-sound dishwashers (Not yet adequately tested for commercial application.)
 Warming tables with dry heat (Water waste due to evaporation is minimal.)
 Garbage disposers using recycled water (Poor customer acceptance; perceived higher labor cost.)
 Off-site food waste disposal (Poor customer acceptance; perceived higher labor cost.)
 On-site water reclamation/treatment (Limited applicability)

NEED FURTHER RESEARCH

One quart micro-flush toilets

TABLE IX-2
OUTDOOR CONSERVATION MEASURE
QUALITATIVE SCREENING RESULTS

ALL CUSTOMER CLASSES - PASSING

Contractor-installed drip irrigation system
 Low-tech homeowner-installed drip irrigation system
 Improvements to existing automatic sprinkler system
 Rain sensors
 Water efficient landscaping
 Water efficient plants
 Turf replacement
 Irrigation scheduling
 Hose control nozzles
 Garden hose timers
 Convert quick coupler system to automatic system (CI&I only)
 Bubbler/soaker hose
 Turbulent wall hose
 Soil sensors
 Mulching
 Gray water system
 Cistern

ALL CUSTOMER CLASSES - FAILING

Soil polymers (Residential and CI&I) (Better measure available.)
 Automatic sprinkler system (Residential only) (Homes with automatic systems use more water than homes with manual systems.)
 Swimming pool covers (Residential only) (Swimming pool covers have limited applicability for residential use in the region.)
 Artificial recreation surfaces (Institutional) (All-weather recreational surfaces may be aesthetically unacceptable.)
 Gray water (CI&I only) (Environmental and health concerns.)
 Miscellaneous agricultural measures (There is a limited number of agricultural customers within the service territory.)

NEED FURTHER RESEARCH

Computerized weather station
 Subsurface turf irrigation
 Swimming pool covers (CI&I application only)

Technology Profiles

After applying the qualitative screen to identify measures applicable to the region, information on their characteristics was compiled into technology profiles. Region-specific data were used when available. Otherwise, the most applicable Pacific Northwest or national data were used. The profiles include the following:

- **Measure Description:** A full technical description of the measure compared to the standard or non-conserving technology or practice, and the end-use and customer class to which the measure is typically applicable.
- **Savings Impact:** Estimates of water savings on a per device, per cycle, per capita, or per household basis as appropriate to the measure. Where possible, estimates were made for subgroups within each customer class. For example, water savings estimates for toilets differ between single-family and multifamily dwellings. Also, savings estimates for outdoor measures were made for small and large lot sizes—2,500 and 5,000 square feet of landscaping, respectively.
- **Measure Life.** This is the expected useful life of the conservation measure. The associated savings will accrue over this period, after which additional costs must be incurred to continue the savings.
- **Cost:** Cost of the measure, including installation, operation, and maintenance costs, where appropriate. Both costs to the utility and costs borne directly by customers are included.
- **Expected Changes in Cost and Penetration:** The current and projected natural market penetration for the measure, as well as state and local legislation or codes affecting the penetration or cost of the measure.

The Economic Screen

Measures that passed the qualitative screen were subjected to an economic screen. The economic screen was used to systematically eliminate measures that were clearly not cost-effective for the region to implement. The economic screen compared the cost of water savings from individual conservation measures with a rough estimate of future supply costs.

A preliminary annualized cost estimate of \$250 per acre-foot was used to represent future supply costs for screening purposes. This estimate was intended to be somewhat larger than the expected actual supply costs to ensure a permissive screen.¹⁵

The economic screen was also made permissive by allowing conservation measures to pass the screen even if they were more expensive than the cost of the future water supply. In other words, a benefit-cost ratio less than 1 was used as the criterion to determine which measures passed the economic screen.

As shortfalls experienced by the region occur in the summer season, outdoor conservation measures, the savings of which are concentrated in the summer, are expected to be more valuable than indoor measures with year-round savings. To reflect this difference, a benefit/cost ratio cutoff of 0.4 was used for indoor measures, meaning that measures costing up to 2.5 times the comparable future supply cost still passed the economic screen. For outdoor conservation measures, a benefit/cost ratio cutoff of 0.2 was used, meaning that measures costing up to 5 times the estimated equivalent supply cost still passed.

These lower benefit-cost cutoffs reflect potential additional economic benefits of conservation not reflected in the screen. These include customer energy savings, reduced O&M costs, and increased property values. In addition, as reflected in the region's policy objectives described in Chapter IV, the region might well choose to implement conservation for a variety of non-economic reasons (e.g. avoided environmental impacts). At this stage, it would therefore be inadvisable to prematurely eliminate measures for purely economic reasons. The screen does enable us to remove those measures that are clearly cost prohibitive.

The costs and water savings of some measures cannot be quantified to support a detailed economic evaluation. For example, many industrial conservation measures tend to be site-specific, or lack data. Therefore, we did not evaluate these measures in the economic screen. They were retained for later program design (see below).

Many of the measures that did not pass the economic screen are retrofit programs for which the alternative is doing nothing. In contrast, measures for which the alternative is assumed to be a less efficient technology often do pass the screen. For example, water-efficient landscaping *is* cost-effective when compared with non-efficient

¹⁵At the time the economic screen was performed, analytically-based cost estimates for the source options were not available. They have since been developed, and this figure does appear to be somewhat larger than the actual costs of the RWSP source options.

landscaping. This is because, in a new installation or in a situation where a consumer has determined to replace his or her landscape in any event, the *incremental* cost of the water-efficient landscape is relatively small.

However, costs to remove existing landscaping and replace it with water-efficient landscaping solely to achieve improved water efficiency are much too large relative to the costs of new supply to justify the water-saving benefits.

Similarly, a horizontal-axis washing machine is cost-effective when compared to a less efficient machine when making a new purchase. However, it is not cost-effective to remove an existing, functional washing machine and replace it with a horizontal-axis machine.

Detailed results of the qualitative and economic screening results are provided in Appendix E. Note that the measures are divided into four categories:

- (1) Measures that have passed both qualitative and economic screens and are incorporated into one or more conservation program concepts (see next section for a discussion of conservation program concept development).
- (2) Measures recommended for further research and future consideration in regional plan updates.
- (3) Measures that did not pass the economic screen.
- (4) Measures that did not pass the qualitative screen.

DEVELOPMENT OF CONSERVATION PROGRAM CONCEPTS

The next step was to combine measures passing both screens into effective conservation *program concepts*. A conservation program is a set of conservation measures bundled for delivery to a defined target market of customers.

This process involved the steps that follow.

Select Target Customer Classes

The customer class designations that were shared most commonly across providers were identified. In some cases, customer classes unique to a particular agency were grouped with the most similar common class designation. For example, accounts coded as schools were grouped with institutional accounts. Five customer classes were ultimately selected as potential targets for conservation programs:

- Residential
- Commercial
- Industrial
- Institutional
- Large landscape (parks, golf courses, large industrial parks, etc.)

Determine Major End-Uses Within Customer Classes

This required determining which equipment and customer behavior could be practically targeted through conservation programs. The following were selected:

- INDOOR: Residential
 - Plumbing fixtures (e.g. toilets, showerheads, faucets)
 - Appliances (e.g. dishwasher, clothes washer)
 - Water Use Behavior (e.g. leaving water running, setting water level too high on clothes washer, running small dishwasher loads)
- INDOOR: Commercial and Institutional
 - Plumbing fixtures (e.g. toilets, urinals, faucets, showerheads)
 - HVAC equipment (e.g. water-cooled vs. air-cooled, single pass cooling vs. closed-loop)
 - Other appliances and equipment (e.g. commercial dishwashers, clothes washers)
- INDOOR: Industrial
 - Industrial processes
 - HVAC equipment

- **OUTDOOR: Residential**
 - Irrigation system equipment
 - Irrigation scheduling practices
 - Landscaping composition

- **OUTDOOR: Commercial, Institutional, Industrial, Large Landscape**
 - Irrigation system equipment
 - Irrigation scheduling practices
 - Landscaping composition

Group Measures

Measures that passed both the economic and qualitative screens were then grouped together according to the target markets and end-uses described above. As an example, ultra-low flush toilets, faucet aerators, and toilet bags are all residential measures that would be grouped under indoor plumbing fixtures.

Define Delivery Mechanisms

A “delivery mechanism” is the manner by which conservation measures are presented to customers, with the objective of encouraging measure installation or adoption. The following delivery mechanisms are listed according to their level of “aggressiveness” of required provider action or financial incentive. The delivery mechanisms described below have commonly been employed in resource conservation strategies of water, gas, and electric utilities.

- **Education/Awareness:** A strategic information campaign designed to influence the general public or key players such as trade allies and manufacturers;

- **Technical Assistance:** A more active program strategy involving tools such as audits, workshops, and hands-on training;

- **Financial Incentives:** Rebates, coupons, and other incentives directed to consumers, trade allies, or manufacturers;

- **Direct Installation:** On-site installation of water efficiency measures;

- Regulation: Codes and/or standards requiring the manufacture, purchase, installation, and use of certain water saving devices and/or practices.

The next step was to formulate the conservation programs. Each combination of target market and end use group was joined with one or more delivery mechanisms. To facilitate the program planning process, program planning matrices similar to Figure IX-1 were created.

On the vertical axis of the matrix, the various delivery mechanism categories are listed. On the horizontal axis, the target markets are shown.

The alternative tools for each target market and category of delivery mechanism are briefly described in each cell of the matrix.

Conservation programs were formulated based on the matrix and on the experience of the project team. Several considerations governed the program development process:

- Organizational and administrative feasibility
- Coherence of objective and public message
- Marketing and administrative costs
- Public acceptability

The end result was 24 program concepts designed to collectively target all markets and end-uses. Table IX-3 shows the program concepts selected.

**Figure IX-1
SAMPLE PROGRAM PLANNING MATRIX FOR SINGLE AND
MULTIFAMILY RESIDENTIAL CUSTOMERS**

SINGLE AND MULTIFAMILY RESIDENTIAL	INDOOR		OUTDOOR		
	Plumbing	Appliances	Irrigation Systems	Irrigation Scheduling	Landscaping
Education/ Awareness					
Technical Assistance					
Financial Incentives					
Direct Installation					
Regulation					

The programs in Table IX-3 are divided into three levels. The programs in each level are increasingly more aggressive. The levels have the following key characteristics:

- Level 1 programs rely heavily on providing education and information to customers.
 - Relies on customer initiative rather than direct provider action or incentives.
 - Relies on strategic public education, information campaigns, and targeted regional workshops.
 - Achieves relatively modest water savings by itself.

In many ways, the educational and informational content of the Level 1 programs forms the basis of all the succeeding programs. Much of what is included in Level 1 is either already being done or is being planned by the region's providers.

**Table IX-3
REGIONAL CONSERVATION PROGRAM CONCEPTS**

	Residential Indoor	Residential Outdoor	Commercial, Industrial, Institutional Indoor	Commercial, Industrial, Institutional Outdoor
Level 1	Public education and awareness	Public education and awareness Customer landscaping workshops Trade ally landscaping workshops—res. portion	Commercial plumbing and appliances education HVAC workshops	CI&I outdoor education and awareness C&I watering practices workshops Trade ally landscaping workshops—C&I portion
Level 2	Indoor audit (combined with outdoor) Appliance incentives and equipment tagging	Outdoor audits Incentives for new efficient landscaping and irrigations systems	Commercial indoor audit HVAC financial incentives Industrial process technical assistance and incentives	CI&I outdoor audits Large landscape audits Incentives for new efficient landscaping and irrigation systems
Level 3	Ultra low-flush toilet rebate	Landscaping ordinance	Ultra low-flush toilet direct installation and incentives Incentives for early retirement of single-pass cooling	Landscaping ordinance

- In Level 2 programs, the providers are more directly involved, offering customers on-site audits, technical assistance, and financial incentives.
 - “Incremental cost-based” incentives pay part or all of the incremental cost difference between less efficient and more efficient equipment.¹⁶
 - Audits focus on working directly with the highest-consuming 20% of customers in each class.¹⁷ Auditors provide hands-on technical expertise and site-specific water-use analyses to facilitate the adoption of efficient practices and equipment.
 - Technical assistance includes plan review, and system/process design assistance.

These programs are generally “market-based” in that they attempt to influence the decisions of customers already in the market for water-using devices, fixtures, materials, appliances, or equipment.

- In Level 3 programs, providers install measures directly on the customers' behalf at little or no cost to the customer. Large incentives are provided to encourage the installation of other measures before the end of their useful lives. Finally, ordinances are employed to accelerate water use efficiency.
 - Full-cost incentives pay part or all of the cost of replacing existing inefficient equipment before the end of its useful life. Examples include providing an incentive for replacing single-pass cooling equipment, or for replacing inefficient toilets.
 - Direct installation of measures would be fully paid by the providers. An example would be the direct installation of ULFTs and ULF urinals for small commercial customers.

¹⁶Incremental-cost-based incentives encourage customers to select water efficient equipment when replacing equipment that has reached the end of its useful life, or when purchasing equipment and facing a choice between equipment with different efficiency levels.

¹⁷The “top 20%” of customers were determined by sorting accounts by level of individual usage. It was then determined how much of the classes' total water consumption this top 20% reflects. For example, the top 20% of accounts in a particular class may account for 50% of the class' total water consumption.

- Landscape and irrigation ordinances are included in Level 3. While low-cost, these programs may be controversial and difficult for some providers to implement.

The brief program descriptions were expanded into detailed program discussions, developing all the program details necessary to understand how the program would be marketed, implemented, and administered, and what the expected participation and savings would be. A list of the elements in each description follows:

- **Brief description**
 - Target market
 - Eligible measures
 - Delivery approach
- **Marketing strategies**
 - Target audience
 - Marketing techniques
- **Program delivery**
 - Delivery approach
 - Technical assistance
 - Financial incentives
- **Participation rates**
 - Eligible population
 - Start-up, annual, and cumulative participation
- **Program costs**
 - Detailed design costs
 - Marketing costs
 - Delivery costs
 - Administrative costs including staffing
- **Program water savings**
 - Annual savings
 - Seasonal savings
 - Savings longevity

CONSERVATION PRICING

Water providers across the country are increasingly using rate design to supplement conservation programs and increase the level of overall water savings. A detailed study of alternative conservation rate designs and incremental savings that could be expected in the region is well beyond the scope of the RWSP. However, given the apparent successes that other providers are having around the country with these approaches, it is important to recognize the savings that might result.

Several providers in the region have already implemented some form of conservation pricing, typically through increasing-block rates.¹⁸ However, an option for all providers in the region is to implement considerably more aggressive conservation rate designs.

Conservation rates and programmatic conservation efforts complement one another, with price signals reinforcing other conservation efforts. However, in developing combined savings estimates for conservation rate design and other conservation programs, it is important to avoid double counting.

Based on evaluations of water conservation rate designs in other parts of the country, savings estimates associated with the other conservation programs and professional judgment, incremental savings due to more aggressive conservation pricing of from 3.5 to 5% of peak season demand are assumed. The exact level depends on the other conservation programs that are implemented. For example, incremental savings of 5% are associated with a conservation rate implemented in conjunction with Level 1 programs, while incremental savings of 3.5% are associated with the implementation of all three program levels.

A full list of the programs arranged by level and their associated savings are shown in Table IX-4.

¹⁸In an increasing-block rate design, customers pay a higher per-unit rate as they consume more.

**TABLE IX-4
SUMMARY OF CONSERVATION SAVINGS**

LEVEL 1 PROGRAMS: EDUCATION AND WORKSHOPS		
	MGD Saved Year 2025	MGD Saved Year 2050
Residential		
Residential Education	3.26	4.32
Residential Customer Landscaping Workshops	0.81	1.52
Trade Ally Landscaping Workshops - Res. Portion	0.82	1.74
CI&I		
Commercial Plumbing & Appliances Educ.	0.35	0.45
HVAC Workshops	0.45	0.45
CI&I Outdoor Education	0.34	0.44
CI&I Watering Practices Workshop	0.14	0.14
Trade Ally Landscaping Workshops - CI&I Portion	0.47	1.22
LEVEL 1 TOTAL:	6.64	10.28

LEVEL 2 PROGRAMS: TECHNICAL ASSISTANCE AND INCENTIVES		
	MGD Saved Year 2025	MGD Saved Year 2050
Residential		
Residential Audits	0.91	0.91
Appliance Tagging and Incentives	2.16	3.07
Residential Outdoor Incentives	5.00	12.90
CI&I		
CI&I Indoor Audits	0.44	0.44
CI&I Outdoor Audits	0.78	0.78
Large Landscape Audits	0.98	0.98
HVAC Incentives	1.33	1.70
Industrial Process Technical Assistance & Incentives	2.01	2.97
CI&I Outdoor Incentives	2.41	6.60
LEVEL 2 TOTAL:	16.02	30.35

LEVEL 3 PROGRAMS: RETROFIT AND REGULATION		
	MGD Saved Year 2025	MGD Saved Year 2050
Residential		
Residential ULFT Rebate	2.05	-
Residential Landscaping Ordinance	8.51	22.05
CI&I		
CI&I ULFT Direct Install and Incentives	2.00	-
Single Pass Cooling	0.27	0.27
CI&I Landscaping Ordinance	4.42	12.35
CI&I ULFT Regulation	3.97	8.05
LEVEL 3 TOTAL:	21.22	42.72

Continued next page

TABLE IX-4
SUMMARY OF CONSERVATION SAVINGS
 (page 2 of 2)

CONSERVATION RATE DESIGN		
	MGD Saved	MGD Saved
	Year 2025	Year 2050
	9.38	12.25

TOTALS		
	MGD Saved	MGD Saved
	Year 2025	Year 2050
WITH LANDSCAPING ORDINANCES	45.85	76.10
% of Average Regional MGD Seasonal Demand [1]	17%	22%
WITHOUT LANDSCAPING ORDINANCES	40.33	61.20
% of Average Regional MGD Seasonal Demand [1]	15%	17%

[1] Figures are based on average MGD price net seasonal demand in the medium scenario for the year 2025 (268 MGD) and 2050 (350 MGD).

WATER REUSE AND RECYCLING

In the Portland metropolitan region, as in many other parts of the United States, interest is increasing in water reuse and recycling, and in the direct use of stormwater and untreated river or groundwater. Typically, these types of supply options are considered for non-potable purposes. They are, however, candidates for potable use in some parts of the country.

The Regional Water Supply Plan included a preliminary analysis of these opportunities. An overview of this analysis follows.

Options evaluated include:

- Stormwater capture
- Cisterns
- Gray water systems
- Recycling of industrial cooling water
- Reuse of treated wastewater effluent

Qualitative and economic screens were applied to the first four options.

Qualitative Screen

Most reuse and recycling measures passed the qualitative screen. These included residential gray water systems, cisterns, and recycled cooling water. Eliminated from further analysis were gray water systems for commercial and landscape applications, and large-scale stormwater storage and pump systems.

Gray Water Systems for Commercial and Landscape Applications

For this project, gray water is defined as untreated laundry, bath, and bathroom sink water that has not come in contact with meat, poultry, or soiled diapers. Gray water is typically considered for irrigation or other outdoor, non-potable or non-contact uses. In Oregon, using gray water as a supply source is not currently permitted. State regulations require that gray water be disposed only through approved on-site septic systems, sumps, and sewage treatment systems. Various regulatory changes would be required, public health issues would need to be addressed, and a consumer education

program would have to be designed and implemented before gray water use could be allowed.

In a residential setting, gray water use may be appropriate given the small scale and the consumer's ability to control how and when gray water is used. In a commercial setting, it is very difficult to control who comes into contact with gray water prior to entering or after leaving the system. Due to concerns over potential health hazards, commercial gray water systems did not pass the qualitative screen and were eliminated from further evaluation.

Large-Scale Stormwater Storage and Pump Systems

During its rainy winters, the Portland metropolitan region experiences substantial amounts of runoff after frequent and often intense storms. Managing this stormwater is increasingly costly and complex due to recent, increasingly stringent regulations on water quality, surface water discharges, and combined sewer overflows (CSOs). Given the need for new water supplies, the RWSP evaluated captured stormwater as a potential way to meet future demand.

As a result of the qualitative screening, large-scale stormwater storage and pump systems were eliminated from further analysis. A primary reason for eliminating this option is the massive storage requirement. Storage requirements for large-scale capture and use would be extensive, involving large land areas and the construction of enormous pipes, tunnels, or reservoirs. Even significant increases in in-town storage would probably provide only a few days additional supply.

Significant water quality issues would also need to be addressed. Because stormwater is generated when rain or melted snow runs off impervious or saturated surfaces into storm sewers, catchment basins, and local streams, runoff contains numerous contaminants, including:

- Petroleum by-products from roads, gas stations, and vehicle lots;
- Fertilizers and pesticides from landscaped areas; and
- Wastes from domestic and non-domestic animals.

CSO flows can also contain contaminants washed from sites where chemicals have been stored in leaking receptacles, and can contain raw sewage and associated pathogens.

Using this water for most non-potable purposes would probably require at least

secondary if not tertiary treatment. Any in-town water storage would need to be covered or otherwise treated to prevent algae growth or the proliferation of disease-spreading vectors such as mosquitoes.

Economic Screen

“Low-Tech” Gray Water Systems

A “low tech” system is defined here as providing up to 50 gallons per day via a 55 gallon drum connected only to laundry facilities. The water would be applied through drip irrigation without a leach field. These gray water systems passed the economic screen if backflow devices are not necessary. However, the additional cost of backflow devices cause this measure to fail the economic screen. Based on analysis and examination of examples from other areas the potential for instituting gray water systems without backflow prevention devices appears extremely unlikely.

Heating, Ventilation, and Air Conditioning (HVAC) and Industrial Recycling

The use of air cooled rather than water-cooled HVAC systems was also found to be economically viable depending on the tonnage size. The cost-effectiveness of various industrial water recycling processes would need to be determined on a case-by-case basis.

“High-Tech” Gray Water

A “high-tech” approach to gray water would involve larger systems with multiple sources (as opposed to solely laundry), applications via subsurface leach fields, and the use of backflow prevention devices. During the economic screen, the cost per water unit provided from a high-tech gray water system was projected to be more than six and one-half times the estimated cost of new supply. Thus, this technology was eliminated from further study in the RWSP.

Cisterns

Cisterns are rainwater collection devices that divert water from roof gutters into holding tanks or barrels that store the water for later use. An overflow device diverts

water back into the storm drain system once the tank or barrel is full. Rainwater is generally clean enough for all non-potable uses, although contamination can occur when water comes in contact with catchment surfaces. Other issues arise regarding regulations prohibiting "standing water," vector control, unforeseen use of cistern water for potable use, and aesthetics.

Water can be collected in cistern systems during the rainy season, but may not be needed during much of the year. The water would be depleted rapidly during spring and summer, but the system would not regularly refill during dry summer months when the water would be most needed. Using the economic screening approach, cisterns' unit cost was found to range from 20 to 33 times more than the unit cost of new supplies. Thus, this technology was eliminated from further study.

Use of Treated Wastewater Effluent

The potential for using treated wastewater for non-potable purposes was also evaluated. In Oregon, the Department of Environmental Quality regulates the use of treated effluent. For purposes of the RWSP, it is recommended that only Level IV, the highest quality of treated effluent, should be considered in meeting identified demands for non-potable supplies. Level IV water can be applied to agricultural crops, including food crops, and to areas where public access is not controlled, such as parks and green spaces and golf courses with contiguous residences.

Currently, two of the ten wastewater treatment plants (WWTPs) in the region provide tertiary treatment required to meet Level IV effluent water quality standards. The Rock Creek and Wilsonville WWTPs have plant capacities of 20 mgd and 2.3 mgd, respectively. The remaining 8 plants have the capacity to provide secondary treatment up to 176 mgd.

Markets

Based on existing information, substantial markets appear to exist for treated wastewater in the region. However, considerable uncertainties remain, particularly in key areas of costs and markets.

Preliminary studies conclude that markets may exist for up to 108.5 mgd of non-potable supplies (e.g., reuse/direct use) in the portion of the region that is currently supplied or is anticipated to be supplied by the Bull Run source (Kennedy

Jenks Consultants). Of that, 60 mgd was for groundwater recharge and plume control at or near the Columbia South Shore Wellfield. Currently, remediation strategies are being evaluated; it is unclear if and how water injection would fit into future remediation efforts.

The results of a Recycled Wastewater Master Plan prepared for the Unified Sewerage Agency (USA) (HDR Engineering, Inc.) estimated that reuse potential could reach about 75 mgd. However, the driving force behind this analysis was to identify readily available, low cost markets for treated wastewater, and reduce effluent discharges to the Tualatin River. The study primarily focused on application of treated wastewater to irrigated agricultural lands. More recently, water quality compliance issues have been addressed, and the effort to keep effluent out of the river has been scaled back. A more focused analysis of the potential feasibility of using treated wastewater specifically for non-potable municipal purposes in Washington County, is required and could yield very different results.

Treated wastewater is currently being used in the region. USA is providing treated effluent from the Rock Creek Plant for irrigation at school fields, two golf courses, a dairy, and a small, light industrial firm. USA is also discussing the option of using treated wastewater with water users in Washington County.

The City of Portland's Bureau of Environmental Services (BES) is exploring reuse options by constructing a facility at the Columbia Boulevard Treatment Plant that will provide Level III treated effluent for irrigation use at the site (currently provided by groundwater wells). Its initial capacity will be 4 mgd. BES intends to expand the capacity to 12 mgd. This facility will be used as a pilot and educational project to provide technical information for use in future program decisions. In addition, BES has contracted to develop a facilities plan, part of which will focus on identifying reuse markets and opportunities to the year 2040.

Preliminary estimates of potential markets for treated wastewater were also developed for Clackamas County. If about one-half the total estimated future park acreage and one-half the existing golf course area could be irrigated using reclaimed water, associated water markets would be approximately 5,000 acre-feet per year, or 9 mgd. Additional markets could probably be identified through a more detailed analysis of land use and future residential and commercial industrial/development potential.

Costs

Preliminary cost estimates vary widely for use of treated wastewater in the region. Current reports show the potential cost of treated effluent ranging from \$700 to \$44,300 per acre-foot. (HDR, Kennedy Jenks) The wide range in cost estimates reflect different assumptions regarding the size of the market, type of treatment plant upgrades, and transmission and distribution requirements. Based on a 1993 national survey of municipal water providers using treated wastewater for irrigation uses, the per-acre-foot costs ranged from \$300 to \$2000. Cost estimates developed for reuse of wastewater from USA facilities are within the cost range of similar system types examined in the national survey.

In the Portland region, potential irrigation markets are expected to be seasonal in nature, while surveyed facilities were located in California and Florida, where irrigation markets for non-potable sources continue nearly year-round. More continuous demand could reduce unit costs for the treated wastewater. Even in the south and southwest, however, alternative discharge or storage facilities are still necessary during low-demand periods.

Conclusion

Given the potential markets and cost-effectiveness associated with wastewater reuse, the region's water providers would benefit from obtaining additional information on markets, costs, constraints, and opportunities. Providers would need to assess the extent of potential wastewater users and the costs of dual distribution systems. It is important to understand how this option can affect the cost of wastewater treatment as well as potential benefits associated with reducing the need for new water supplies. It will also be useful to consider installing dual systems in conjunction with new developments rather than installing retrofits. Finally, it is critical to understand the needs and the perceptions of the public in order to gauge education requirements and the acceptability of reused water for different purposes.

Direct Use of Untreated Surface Water and Groundwater

Direct use of untreated surface water and groundwater was not evaluated as part of the RWSP, although direct use may play a key role in meeting the region's non-potable demand. The amount of direct use actually occurring is difficult to quantify. Region-wide, it is likely that substantial irrigation demands (and some industrial

demands) are met through existing on-site or nearby groundwater wells and surface water diversions. In the short-term, direct use systems are expected to be developed on a case-by-case basis at sites adjacent to available surface water and groundwater sources. The RWSP demand forecast implicitly assumes that the proportion of future water demands met through direct use will be the same as it is today.

One example of direct use is found at the Port of Portland, which recently acquired municipal water use permits to use Willamette and Columbia river water for non-potable industrial and irrigation uses. Direct use by the Port should, over time, substantially reduce the demand on the Bull Run potable water supply system.

One previous study projected direct use (groundwater) costs to be lower than for reuse of Level IV treated wastewater. (Kennedy Jenks) However, it may be difficult to obtain new water rights for surface water or groundwater hydraulically connected to surface water. In addition, portions of the region (e.g., the Columbia River Basalt aquifer in Washington County) have declining groundwater levels, and future uses of the resource are (or may become) restricted.

Given the potential benefits and efficiencies associated with shifting non-potable water demands away from potable water supply systems, it may be worthwhile for water providers to continue exploring direct use opportunities during implementation of the Regional Water Supply Plan.

Follow-up Activities and Coordination

Based on the discussion above, the region would benefit from continued evaluation and exploration of potential non-potable source options including on-site recycling and reuse, reuse of treated wastewater effluent, and direct use of surface and groundwater. These options should be analyzed within the context of the region's overall water resource picture for the short- and long-terms. Near-term activities that would help the region refine its understanding of non-potable source potential might include:

- Evaluate baseline non-potable uses and trends.
- Assess markets and costs of reclaimed wastewater region-wide.
- Analyze direct-use/dual systems options.
- Examine potential for water reuse and recycling in the non-residential sector, with a focus on high-volume users.
- Explore potential for graywater sources and regulatory issues.

- Assess the potential to transfer water uses (e.g., points of diversion, places of use, and types of use) under existing water rights (e.g., irrigation to municipal, surface water to groundwater) to meet multiple purposes.
- Investigate public education needs.

The water providers participating in the Phase 2 planning effort have coordinated with the region's major wastewater management agencies at several work sessions and at regularly scheduled meetings of the Metro Water Resources Policy Advisory Committee (WRPAC). Continued and increased coordination with wastewater service providers, other agencies, and water user stakeholders, will be necessary to reach a better understanding of the future role of water reuse and recycling in the Portland metropolitan region.

CONCLUSION

Each conservation program described in this chapter is viewed as a resource option that may be part of a long-term regional resource strategy, along with particular supply options. The next chapter discusses the modeling tool used to develop alternative sequences of resource additions and evaluate them against the RWSP evaluation criteria.

X. A DESCRIPTION OF THE MODELING TOOL

X. A DESCRIPTION OF THE MODELING TOOL

INTRODUCTION

The preceding chapters have described the huge quantity of information that has been developed in the RWSP on a variety of topics. Policy objectives and associated evaluation criteria were developed, water demands were forecast, source options were characterized along a number of dimensions, transmission alternatives were analyzed, and conservation programs were designed. All of these results needed to be integrated to develop, evaluate, and thoroughly describe alternative long-term resource paths from which the region will choose.

Accomplishing this required a sophisticated modeling tool that could:

- Handle large volumes of information;
- Simulate the operation of the regional system under a range of demand, weather, and streamflow conditions;
- Assess a wide variety of future resource paths against the region's evaluation criteria and make tradeoffs among them apparent;
- Run quickly;
- Be relatively easy to operate; and
- Produce information in a form that is easily understood by different audiences.

Consistent with one of the RWSP's underlying premises, the desired modeling tool would not "optimize" or, in any sense, choose the "best" future resource path for the region. Rather, it would provide information in a form that will help the region's policymakers make such choices.

IRPlanner is the model that was created to meet these needs. It was designed to analyze alternative user-defined resource strategies. Strategies involve supply additions, conservation programs, and transmission linkages, along with user-specified assumptions about water demands, resource on-line dates, escalation rates, discount rates, and other variables.

IRPlanner is a Windows application that performs well on most 486 DX-based computers, and will operate on a 386-based machine equipped with a math coprocessor. The model is configured in two modules: a Windows-based user interface and a FORTRAN-based computational driver. The computational module is launched automatically from the User Interface, and its inputs and outputs are interpreted by the User Interface.

Figure X-1 provides an overview of the model.

The User Interface

The User Interface is compiled using Microsoft Visual Basic, which allows a detailed graphical user interface Windows application to be created. A unique feature of the interface is its ability to access and edit virtually all input data simply by clicking on various icons on a "live" regional map. The map used for the Portland region is shown in Figure X-2. The interface is customized explicitly for particular variables of interest and relevant resource options. The interface allows the user to easily and intuitively modify inputs, specify outputs, and perform all file management functions. The user interface also allows the user to view desired outputs (e.g. charts, graphs, and tables) and to easily adjust their form and appearance.

Figure X-1
IRPlanner Overview

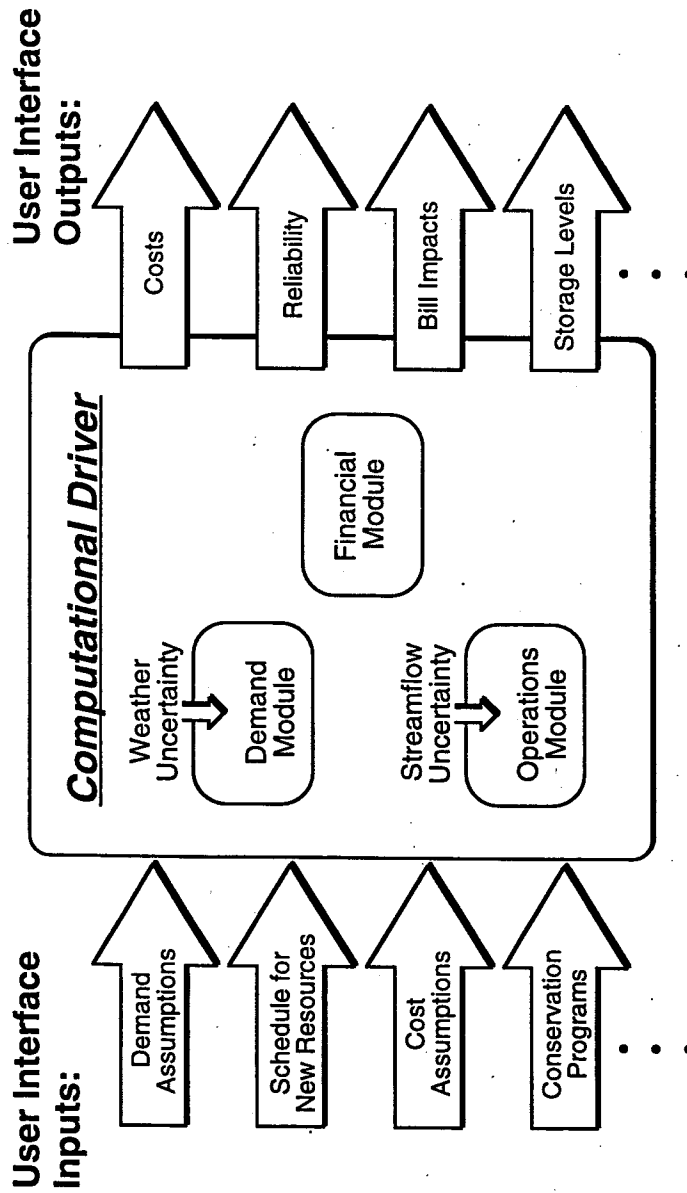
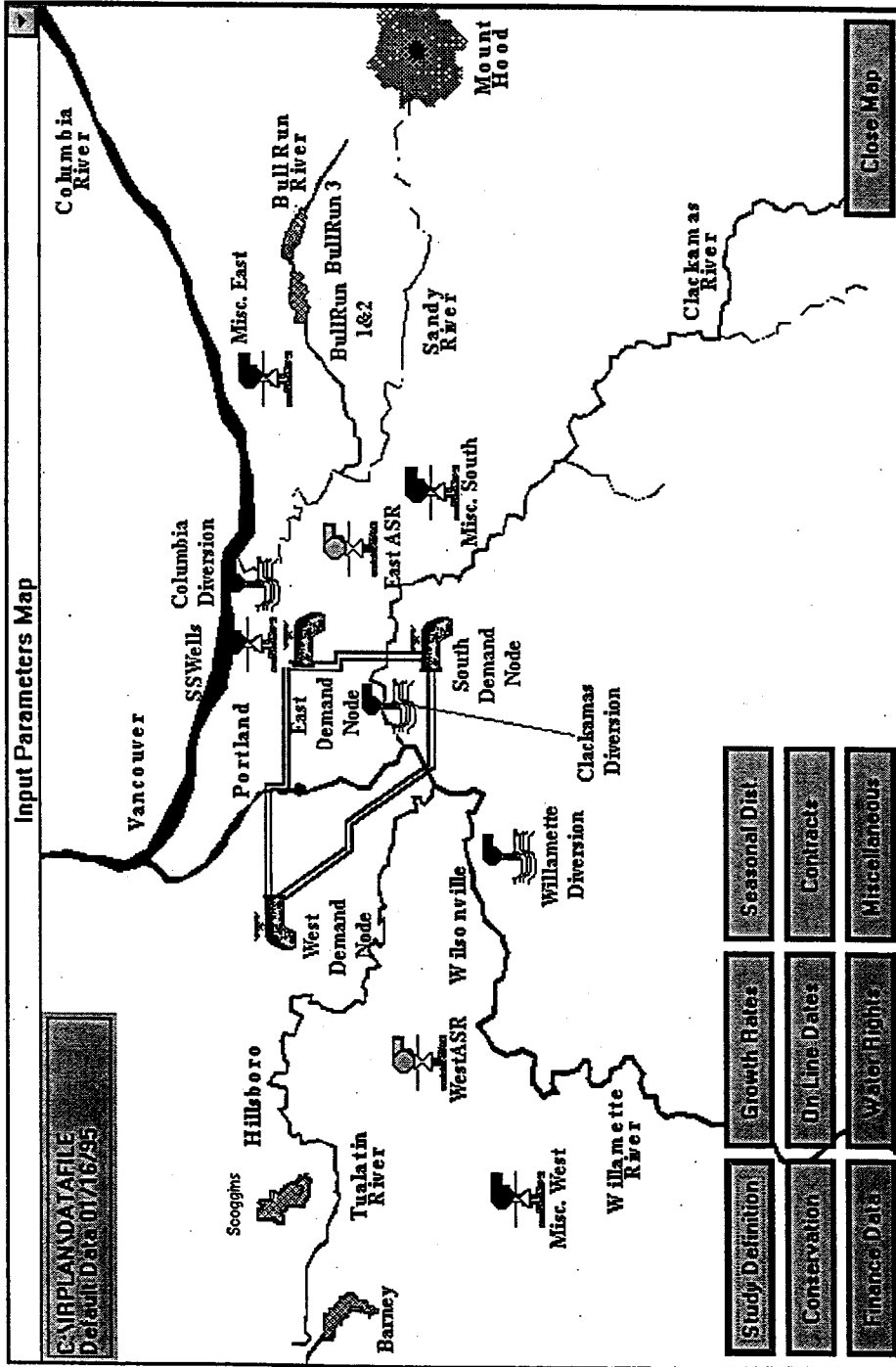

Figure X-2
Input Parameters Map



Computational Driver

Resource sequences specified in the user interface are analyzed using the computational driver. This portion is a compiled DOS application using Lahey Fortran 90. Although the computational driver can be executed from DOS, the user normally launches it directly from the user interface, making *IRPlanner* as seamless as possible.

The computational driver uses Monte Carlo simulation techniques and network flow algorithms. Submodels address operations of surface and groundwater storage facilities.

Underlying Data

The model has an extensive underlying data base, which includes the following data:

- **Daily temperature and precipitation.** For a 65-year period of record (1928-1992), the model stores daily average temperature and total precipitation records. These form the basis of the model's computation of three sets (low, medium, and high) of estimated daily demands.
- **Streamflows.** For the same period, streamflows are included for each of the four surface source options, as well as the fifth major surface source for the region—the Trask/Tualatin system. For the Clackamas and Bull Run, where the water availability analysis indicates the potential importance of daily flow variations, daily streamflow data is used. For the other sources, monthly averages are relied upon.

MODEL INPUTS

Inputs are made through the Visual Basic interface via the live regional “map” discussed above. To modify any input, users simply click on the appropriate phrase or icon on the map. A screen will appear with the relevant data. The data can then be modified and saved. Major model input categories include:

- **Source options.** The user can specify the magnitudes, on-line dates, operating life, fixed and variable costs, and comparative evaluation ratings for each source option. For the Clackamas, Willamette, and Columbia, staged implementation is permitted. The user also chooses rates at which various cost categories will increase over time, and the

financing term and interest rate for the amortization of capital costs. Finally, the user must indicate what percentage of the source, if any, can be displaced during any time period if there are other sources that are less expensive to operate.¹⁹

- **Transmission options.** The user can easily define new transmission linkages among the three nodes. The user can also specify the flow capacities in either direction, on-line dates, fixed and variable costs, cost escalation rates, and financing terms.
- **Demands.** The model divides the region into three demand “nodes.” The east node corresponds to providers in Multnomah County; the west node includes Washington County providers; the south node includes providers in Clackamas County. The user can specify whether a high, medium, or low demand forecast should be used.
- **Conservation.** Users can determine which individual conservation programs would be implemented for each node. For each program, the user can specify the program start date.
- **Water rights and instream flow constraints.** The user can modify the sequence of prioritized water rights for each surface source and set minimum streamflows which may constrain the operation of the source option.
- **Contracts.** The user can specify the terms and duration of any contracts between providers that require particular flows between two demand nodes. An example is the current City of Portland contracts with various providers for delivery of Bull Run supplies.
- **Operating Constraints.** These include issues such as triggers for and limits to use of the Southshore Wellfield, limits on the drawdown of Bull Run and Barney storage reservoirs, and constraints, if any, on the sources and timing for ASR injection.
- **Study Definition.** The user must define the parameters of the simulation. This includes setting the study start and end dates, the number of simulations, the manner in which samples will be drawn from

¹⁹Local, transmission-isolated sources may not be displaceable.

historical recorded weather and streamflow data, and whether the system will be simulated on a monthly, weekly, or daily basis.

SIMULATING THE SYSTEM

The model treats weather and streamflow as randomly-occurring, or "stochastic," variables and uses a Monte Carlo technique to simulate the system.

As the model moves through the user-specified study period, it assigns to each operating year a selected set of weather and streamflow conditions associated with a particular year from the historical record. This historical year is selected according to sampling instructions given by the user. The selection can either be random, sequential, or a fixed designated historical year. The model then steps through each operating year using the monthly, weekly, or daily time steps defined by the user.

For each monthly, weekly, or daily period or "time step," demand for each node is computed. The model's demand calculations for each demand node are based on the demand forecasting results described in Chapter V and on the daily weather data described above. For monthly simulations, the model uses a reduced form version of the demand forecasting model. In any month, observed monthly average temperature and precipitation drive the monthly demand for each customer class for each node.

For weekly and daily simulations, additional coefficients were introduced to capture the sensitivity to weather variations within each month. These coefficients allow the estimation of daily demands, while ensuring that the mean monthly demands and 95%-confidence-limit peak-day demands derived by the Chapter V demand forecast are replicated.

These demands are adjusted for conservation savings applicable to the period, thus providing the net demand to be met by the water supply system.

Simulating the manner in which the supply system meets remaining nodal demands in the period is accomplished through a two-step process. First, the supply *available* from each on-line source is computed. Supply projects fall into four general categories: reservoir storage, diversion projects without upstream storage, groundwater sources, and aquifer storage and recovery sites. For each source type, different algorithms are used to determine supply availability; these algorithms reflect individual project physical constraints, streamflow conditions, water rights, and assumed operations.

Each supply block is assigned a "shadow price" used to determine the most economic utilization of available supply. Typically, this price is the variable operating cost for each source, but it can be higher to reflect the future value of storing water and preventing reservoirs from being too deeply drafted.

After the supply availability algorithms are completed, the model uses a network flow technique to determine the most economically efficient use of the available supply. The approach generally follows these steps:

- (1) An attempt is made to satisfy any outflowing contract demand requirements for each demand node. This is done with local non-displaceable supply, then with other locally available supplies in order of increasing shadow price.
- (2) An attempt is made to serve each node's demands with that node's resources. This is done with remaining non-displaceable supply, then with other locally available supplies in order of increasing shadow price.
- (3) An attempt is made to meet still-unserved demand at any node by serving that demand from other sources. This is done subject to transmission capacity constraints.
- (4) An attempt is made to reduce system operating cost based on the shadow prices of each supply block and the transmission pumping costs, if any, to move water between nodes. This step is again subject to transmission capacity constraints.

The model then records information about system operation for this period (day, week, or month). This includes information on unserved demand, source use, and transmission flow. The information on source use is used to determine ending storage volumes for reservoir projects and instream flows for diversion projects. Production costs for the period are also calculated and are ultimately aggregated for each year.

These steps are then repeated for the next daily, weekly, or monthly time step.

Supply and transmission project construction cash flow and financing requirements are calculated by a capital costing module. Conservation investments are tracked, and can be allocated between utilities and customers, with each portion being separately financed. The capital costing module produces a time series of annual revenue

requirements associated with capital investments. These are combined with the supply source production costs to produce the stream of total revenue requirements.

The cost components captured in the model include operating costs for all existing and new supply, conservation, and transmission projects, and capital costs associated with new investments.

A single simulation steps through all the time periods specified by the user. To capture the random nature of weather and streamflows, the simulation is repeated as many times as the user specifies.

MODEL OUTPUTS

Once the simulation is run, the user can select from literally dozens of graphical and tabular outputs. The output categories provide information on most regional policy objectives. Other outputs assist users in understanding the implications of a particular sequence. Key outputs include:

- Cost and rate impacts
- Water supply reliability
- Comparative ratings (e.g. raw water quality, environmental impacts)
- Usage of individual sources
- Reservoir storage levels
- Conservation savings
- Transmission loadings
- Instream flows

The model also allows for direct graphical comparison of many of the output results between two resource sequences. This is an extremely useful feature for understanding key tradeoffs.

All output results can be read to a data base, which can then be exported to allow the user to customize other graphical and tabular presentations.

CONCLUSION

IRPlanner has proven to be an invaluable tool in developing and analyzing alternative resource sequences. In addition, it has deepened the understanding of critical issues

facing regional water providers. As the plan is updated throughout the planning period, the model will be available to help providers understand and respond to changing conditions.

XI. DEVELOPMENT OF RESOURCE STRATEGIES

XI. DEVELOPMENT OF RESOURCE STRATEGIES

The final analysis conducted in preparation of the Preliminary RWSP was to design and evaluate a set of *resource strategies*, each of which can meet the region's future water demand. Strategies, in this context, include different combinations of resource options, including conservation, transmission, water supplies, and series of actions needed or recommended for implementation of the options.

As pointed out earlier, a basic premise of this planning effort is that a single "best" future resource strategy for the region does not exist. Rather, there are many possibilities that reflect the tradeoffs the region must make among the policy objectives.

This chapter presents several alternative strategies that were designed to illustrate and explain key choices available to policymakers. The evaluation of these strategies was conducted by applying evaluation criteria associated with applicable policy objectives. The results and preliminary recommendations were considered during a several-month-long public review of the Preliminary RWSP. The results of this review process, along with final recommendations, are presented in Chapter XII.

WATER SUPPLY RELIABILITY: A KEY CHOICE FOR THE REGION

One of the fundamental policy objectives presented in Chapter IV of the RWSP is to address the issue of water supply reliability. In many ways, supply reliability is basic to the RWSP, as concern about future *unreliability* is the key reason the region's providers joined to develop the plan. The reliability issue is embodied in the policy objective to "minimize the frequency, magnitude, and duration of water shortages."

Two policy objectives deal specifically with system reliability. One objective refers primarily to weather-driven supply shortages that occur during hot dry periods. A separate policy objective addresses system reliability in terms of impacts of catastrophic events. While a wildfire, flood, slide, volcano, or spill could potentially interrupt a portion of the regional supply, these types of events are much less predictable, and usually much more sudden, than a shortage caused by peak season imbalances between supply and demand. The actions necessary to minimize the impacts of catastrophic events may differ from actions the region would take to minimize weather-driven supply shortages. The catastrophic events policy objective is discussed later in this chapter. The current section is devoted to reliability as a function of supply/demand imbalances.

The region must ultimately choose desired levels of future peak event shortage risk, just as it must make choices about other policy objectives. Indeed, tradeoffs occur between increased reliability levels and other important objectives, such as minimizing costs and environmental impacts. Policymakers must understand the consequences of different reliability levels to make informed decisions. To accomplish this, resource strategies were defined for each of three shortage risk levels (referred to in the remainder of the discussion simply as “system reliability”).

Defining Levels of Reliability

During any period, in any geographic area, and under specified weather and streamflow conditions, reliability (i.e., the system's ability to fully serve the demand for that period, in that area, under those conditions) is a function of the availability of supplies, the levels and both temporal and geographic distribution of demands, and the ability to deliver those supplies to the demands. Supply availability and demands depend, in turn, on weather, streamflows, population, land uses, and the manner in which the system operates. As discussed in Chapter X, the *IRPlanner* modeling tool simulates all these features.

Though there are many ways to express the reliability of a water supply system, the evaluation criteria laid out in Chapter IV focus on three key reliability indices:

- **Probability of Shortage (POS):** The likelihood that any shortage will occur.
- **Probability of Designated Shortage (PODS):** The likelihood that the magnitude of a shortage will be greater than a specified level. For example, the 10% PODS is the probability of a shortage greater than 10%.
- **Expected Unserved Demand (EUD):** The expected fraction of demand that is not met.

For example, one index of reliability for the year 2020 might be the probability of a shortage greater than 5% in the west node over the summer season under “typical” (or randomly selected) weather and streamflow conditions. Another might be year 2040 expected unserved peak day demand for the entire region under the most severe historical weather conditions.

Shortage Types

A distinction must be made between two types of shortages. The first is *volume-driven* and results from an insufficient total supply of water in a region over a given time period. Volume-driven shortages are generally caused by low streamflows and/or inadequate storage volumes combined with sustained high demands. In the Portland region, the 1992 event was a volume-driven shortage.

The second type of shortage results from *insufficient delivery capacity* to meet demands on particular high-demand days or hours. The capacity "bottleneck" may occur in various parts of a system, including intakes, treatment plants, transmission mains, pumping plants, and so on. When this occurs, there is sufficient water, but it cannot be delivered at the rate it is being demanded.

Operationally, important differences exist between the two types of shortages. Volume-related shortages can be spread over a lengthy period (e.g. weeks or months) to "stretch" available supplies through extended usage reductions, as occurred in part of the region in 1992. Capacity-driven shortages cannot be spread, and rely on the use of distribution storage and/or the "immediate" reduction of customer demands.

As described in Chapter VI, the Phase 2 "base case" includes a variety of supply resources that the region's water providers are committed to developing during the next 2 to 10 years. These committed resources total nearly 80 mgd not available in 1992. With those sources, the region should have sufficient water volumes to meet even high demands²⁰ were 1992 flow conditions²¹ to occur again at any time throughout the planning period.

Given existing and committed resources, and the means to transport water to areas of demand, the Portland region in aggregate is projected to have sufficient water supply volumes to avoid all seasonal volume-related shortages for the entire planning period (i.e. through 2050), even under high demand and low stream flow conditions.

²⁰Strictly speaking, near the end of the planning horizon, 1992 conditions would result in small volume constraints under high demand assumptions. Long before that point, however, additional resources would have been added to address the region's capacity needs. These resources would add more than enough water to the regional system to preclude the possibility of volumetric shortages.

²¹1992 was the worst streamflow year on record.

Although the region should not have to concern itself with summer-long water shortages, it *will* however, without new resources, face shortages of delivery capacity on high-demand days. Since water demand varies with temperature and precipitation, the severity of these peak-event shortages will vary depending on weather conditions. The region's historical weather pattern indicates these peaking events occur infrequently and are fairly short.²² On the vast majority of summer days, demand does not strain system delivery capacity. Therefore, average shortages during the summer season can be expected to be insignificant or of short duration.

Figures XI-1 and XI-2 illustrate the reliability of the system with *current* on-line resources, that is, excluding the approximately 80 mgd of committed supply that is not yet operational. Figure XI-1 shows the expected magnitude of regional peak-day shortages (expressed as a percent of total demand) over the planning period, assuming typical historical weather conditions and high demands. Figure XI-2 presents similar information, but for the hottest and driest historical daily conditions rather than for typical weather.

Not surprisingly, the graphs show that the expected magnitude of these shortages will increase as projected demands increase over the planning period. The graphs also show that, under typical weather conditions, with current resources and facilities, shortages would begin to appear around 2004 and rise to more than 35% by 2050. On days approaching historically high temperature levels, shortages could reach 50% of peak day demand.

Figures XI-3 and XI-4 show identical information, but with *base case* (i.e., current and committed) resources. The graphs also show that even with high demands and no additional conservation savings or supply beyond the base case, shortages in delivery capacity do not begin until around 2017. From that point, expected peak-day regional shortages would rise to almost 25% by 2050. On days approaching historically-high temperature levels, this could rise to close to 40%. As illustrated in Figure XI-5, portions of the region would suffer devastating service reductions.

²²Historically, hot weather events have almost never lasted more than five days.

Figure X1-1

Expected Peak-Day Regional Shortage: Current Resources, High Demand Forecast

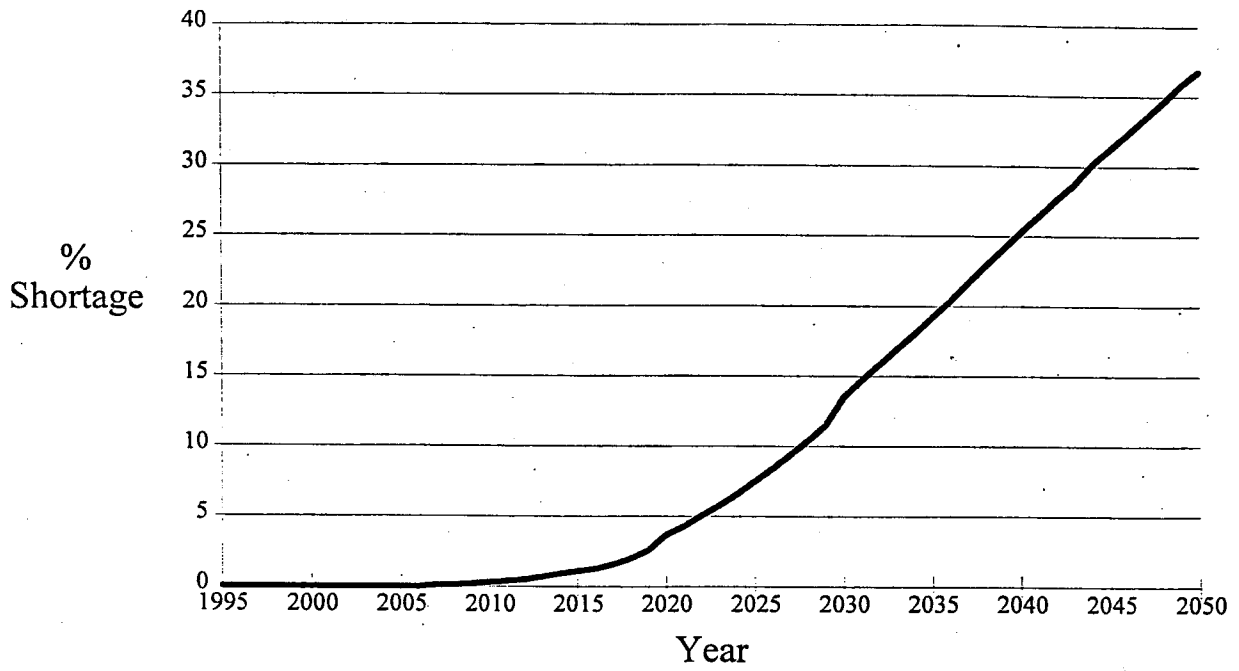

Figure X1-2

Worst-Year Peak-Day Regional Shortage: Current Resources, High Demand Forecast

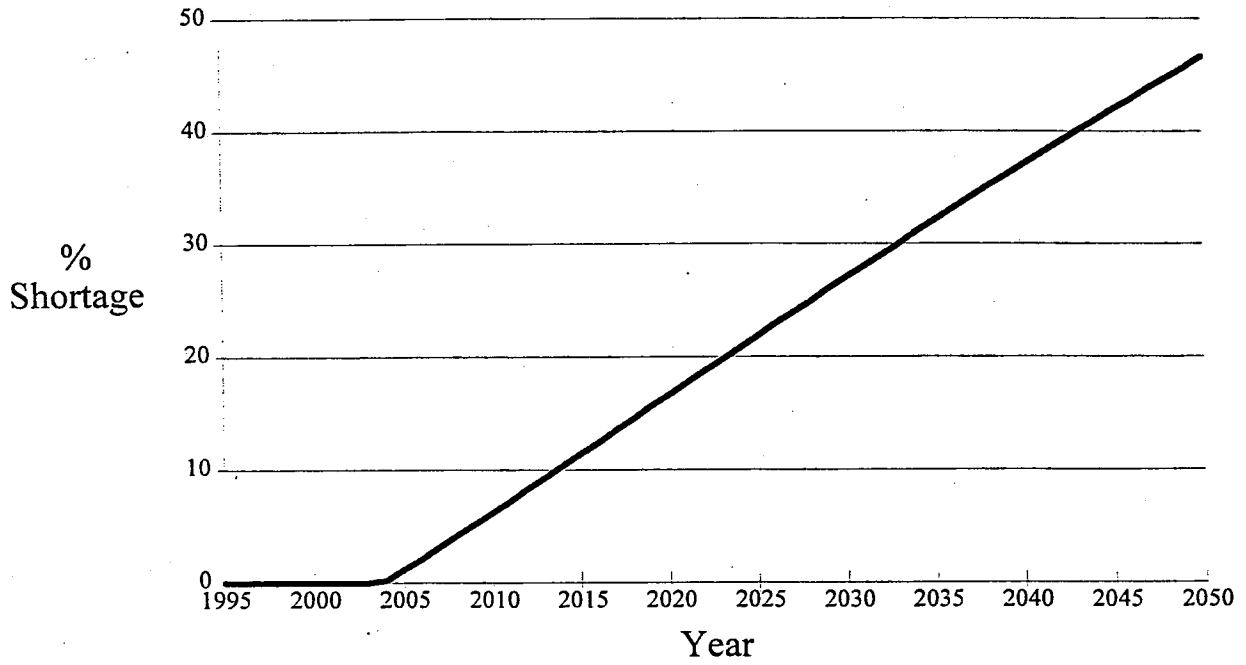

Figure X1-3

Expected Peak-Day Regional Shortage: Base Resources, High Demand Forecast

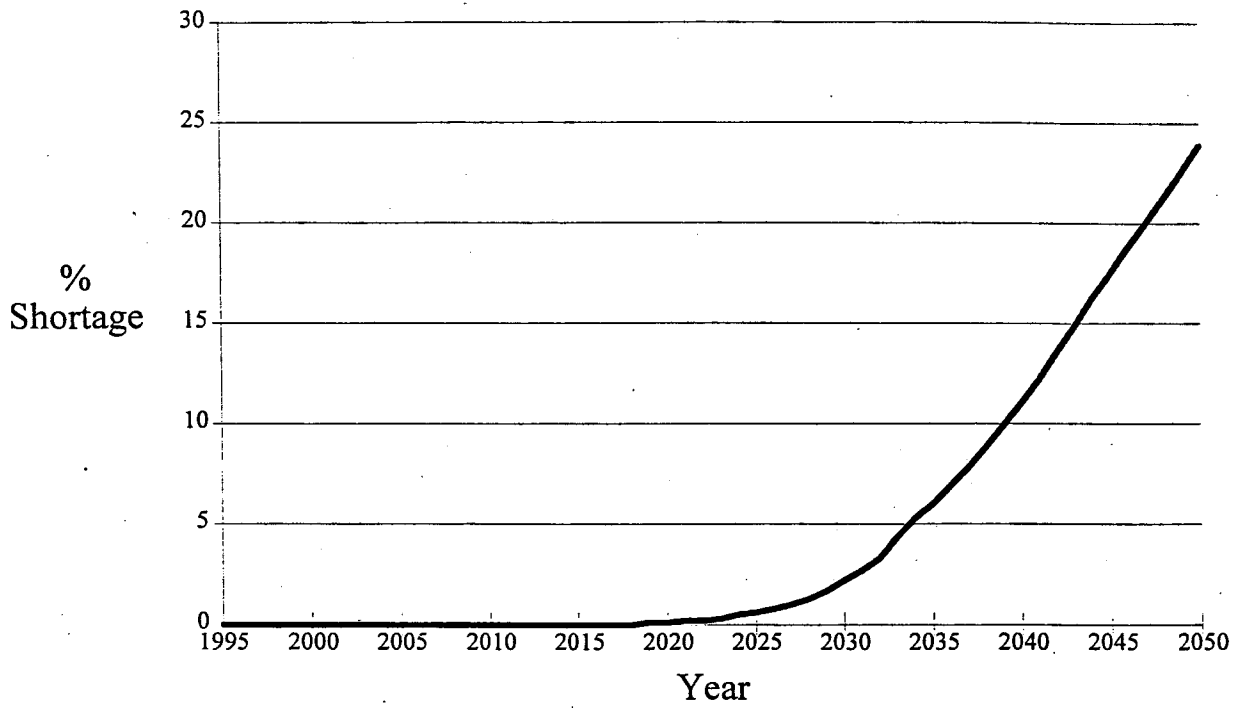

Figure X1-4

Worst-Year Peak-Day Regional Shortage: Base Resources, High Demand Forecast

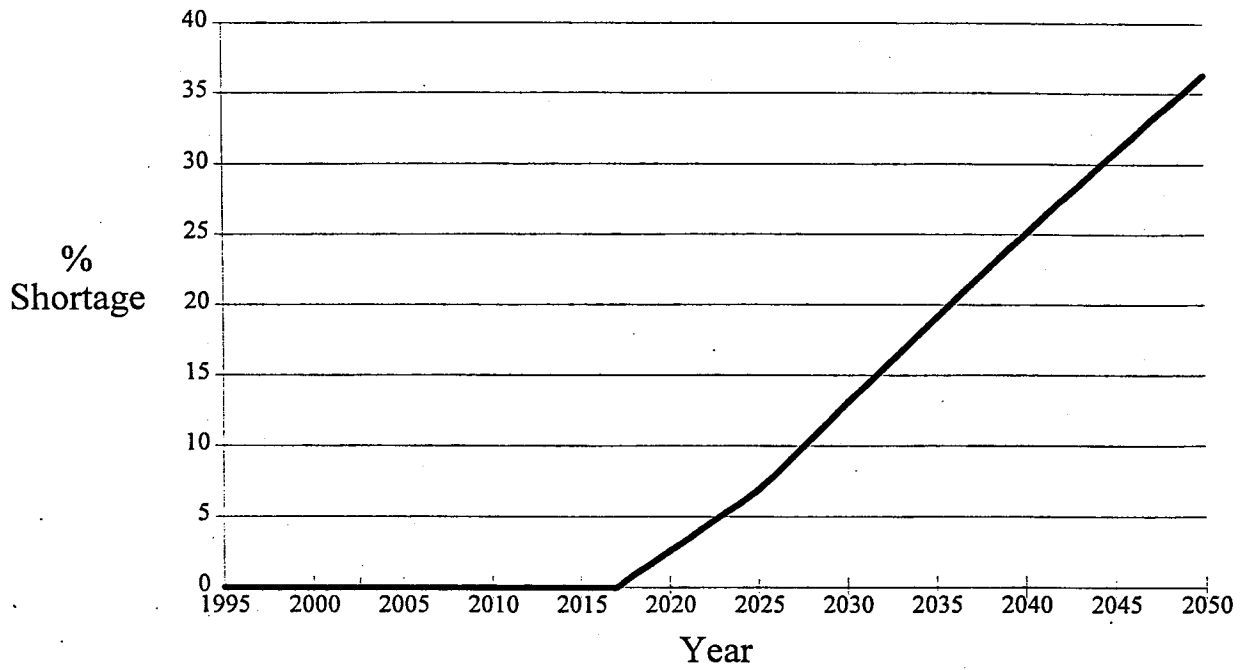
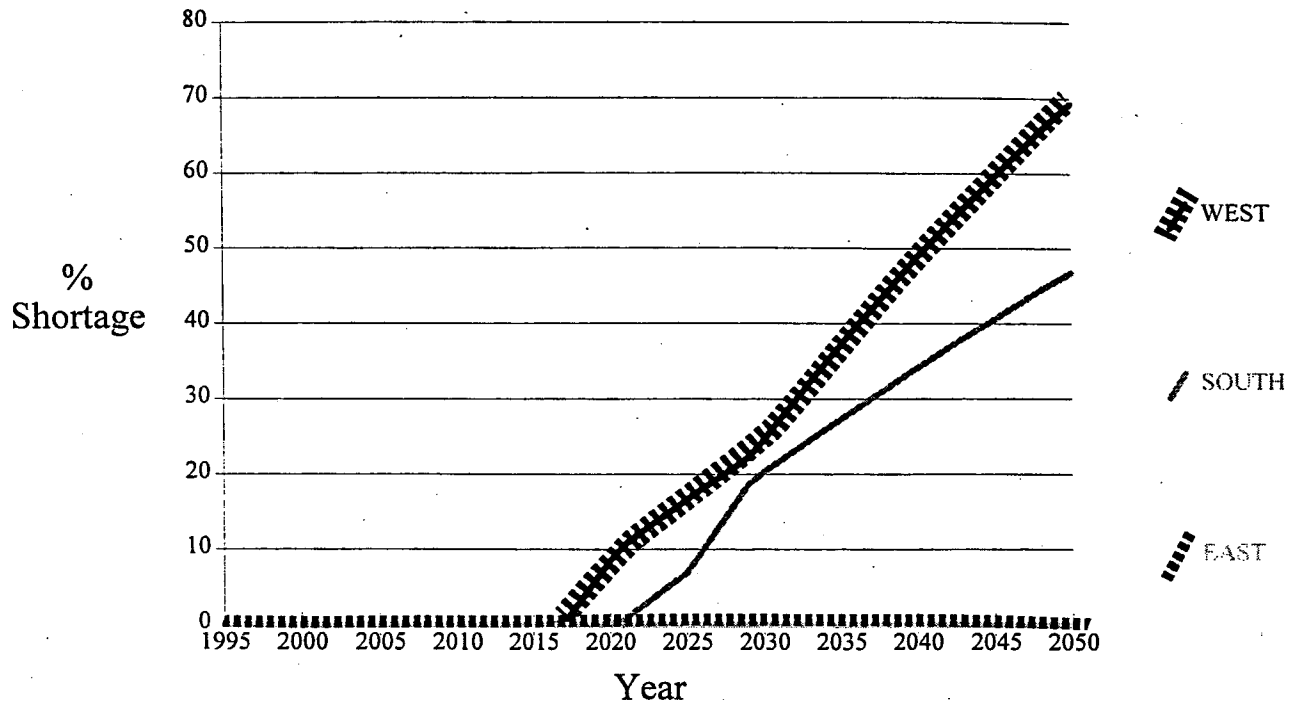

Figure X1-5

Worst-Year Peak-Day Shortage by Node: Base Resources, High Demand Forecast



The region's water providers assume these projected shortage levels are unacceptable. Resources must therefore be added to improve future reliability while recognizing and balancing other important policy objectives. (For example, a more reliable system may cost more and result in greater environmental impacts.) The question that the region must address is how much should reliability be improved, or, put another way, how much *unreliability* is acceptable. One way to assess the question is to evaluate the trade-offs associated with several different hypothetical reliability levels.

Since the region must concern itself with peak-day-driven shortages in delivery capacity, the alternative reliability levels should be defined accordingly. Thus, the key distinctions in reliability relate to the magnitude and frequency of shortages during peaking events. Table XI-1 provides several indices that characterize three levels of reliability which were chosen for incorporation into the different resource strategies.

**Table XI-1
THREE LEVELS OF SYSTEM RELIABILITY**

	Highest Nodal Peak-Day Shortage Under Worst Historical Weather	Probability of Any Nodal Peak-Day Shortage	Probability of 5% Nodal Peak-Day Shortage	Probability of 10% Nodal Peak-Day Shortage	Probability of 15% Nodal Peak-Day Shortage	Expected Peak-Day Shortage
Level 1	0	0	0	0	0	0
Level 2	10%	15%	6%	0	0	1%
Level 3	20%	20%	15%	12%	5%	2%

■ **Level 1 Reliability:** A resource strategy that achieves Level 1 reliability would not result in shortages for any portion of the region for any time under any historical weather and streamflow conditions. This is, in other words, a perfectly reliable system.

■ **Level 2 Reliability:** A resource strategy that achieves Level 2 reliability would result in some small and infrequent shortages. As shown in Table XI-1, a Level 2 system would allow no more than a 10% peak day shortage for any demand node under the

worst e.g., hottest, driest historical weather conditions.²³ At those points in the planning period when demand approaches supply capacity:

- A peak-day shortage of some magnitude in at least one node can be expected to occur under 15% of the historical weather conditions;
- A peak-day shortage that exceeds 5% in at least one node can be expected to occur under 6% of the historical weather conditions; and
- The expected peak-day shortage under *typical* weather conditions for the most severely-affected node would be about 1%.²⁴

■**Level 3 Reliability:** A resource strategy that achieves Level 3 reliability would result in some additional peak-day shortages. As shown in Table XI-1, a Level 3 system would allow no more than a 20% peak day shortage for any demand node under the worst (e.g., hottest, driest) historical weather conditions. At those points in the planning period when demand approaches system capacity:

- A peak-day shortage of some magnitude in at least one node can be expected to occur under 20% of the historical weather conditions;
- A peak-day shortage that exceeds 5% in at least one node can be expected to occur under 15% of the historical weather conditions;
- A peak-day shortage that exceeds 10% in at least one node can be expected to occur under 12% of the historical weather conditions;
- A peak-day shortage that exceeds 15% in at least one node can be expected to occur under 5% of the historical weather conditions; and
- The expected peak-day shortage under *typical* weather conditions for the most severely-affected node would be about 2%.

²³In other words, this is the largest shortage that would occur on the hottest day on record over the 65-year historical period.

²⁴Note that these are the maximum possible values of all of these indices. When these values are approached, resources would be added. This implies that, in most years of the planning period, system reliability would be better than indicated by these figures.

Under either Level 2 or 3, individual providers would face choices on how to deal with lower service levels from the regional supply system. Some providers could choose to serve their customers at these levels, with the attendant curtailments. Others could choose to take other actions, such as developing additional local storage. Recall that the RWSP does not explicitly address the operational issues of these local systems.

THE RESOURCE OPTIONS: SOME KEY OBSERVATIONS

Before tracing the development of resource strategies designed to achieve each of these three reliability levels, it is useful to highlight the key features of the individual resources. Brief discussions of supply source options are followed by a discussion of conservation programs.

Bull Run Dam 3

The Bull Run source provides the highest raw water quality and degree of source protection of any of the supply sources. There are significant costs and environmental problems associated with developing Dam 3, and possible difficulties in securing permits may also make Dam 3 a very difficult resource to develop. There may be ways to offset some of the environmental impacts, e.g., on fish resources, through flow augmentation and other measures. New information on mitigation approaches should be incorporated into further options analysis during plan implementation.

The source is located relatively far away from portions of the region that will experience shortfalls over the planning period. The magnitude of the Dam 3 project makes it an inflexible resource in terms of the region's ability to respond to future demand uncertainties. Additional development of Bull Run will increase the region's vulnerability to catastrophic events by increasing the region's dependence over time on this single source.

Clackamas River

The Clackamas is a proven source with high raw water quality. The Clackamas watershed has not been highly developed to date, but is slated for substantial population and economic growth over the planning period. The Clackamas is favorably-located as significant shortages are anticipated in Clackamas county. The potential environmental

impacts of smaller capacity additions (up to about 50 mgd) on the Clackamas appear to be small. Larger increments would result in larger impacts to the natural environment.

Source development on the Clackamas is limited by the size of the river and existing water rights. Since it is an already-existing source, additional development on the Clackamas will not by itself make a large contribution to reducing the region's vulnerability to catastrophic events.

Willamette River

The raw water quality of the Willamette is generally good relative to sources nationwide but lower than the Bull Run and the Clackamas. The Willamette is a difficult watershed to protect because its size, multiple jurisdictions, and land ownerships, and existing and future upstream development. The representative intake site is located near the areas in Washington County where future shortages are anticipated. Developing water supply to help meet the region's future demand is expected to have relatively minor impacts on the natural environment.

Implementation issues on the Willamette are many and complex, but generally it is felt it would be considerably easier to develop up to 154 mgd of Willamette capacity (the permits currently held by regional providers) than to develop higher levels. The Willamette is a relatively expensive source to develop and operate, due in part to the distance between the representative intake and treatment plant site and the terminal reservoir site. As a new source, located in the southern portion of the region, the Willamette would help reduce the region's vulnerability to catastrophic events.

Columbia River

The raw water quality of the Columbia is slightly better than the Willamette, but is lower than the Bull Run or the Clackamas. The size and land use/ownership diversity of the watershed makes protection highly problematic, although flow rates in the Columbia result in a high dilution potential as well. Environmental impacts associated with Columbia source development could be moderate to significant, although not as large as those potential impacts associated with Bull Run Dam 3. The Columbia is distant from the south and west parts of the region where it is anticipated that future needs will occur.

Water availability on the Columbia is not an issue, although obtaining water rights may be. Currently, the only municipal water right application on file by a regional provider is 77 cfs (50 mgd) by Rockwood PUD. Implementation issues on the Columbia are difficult to predict, but fishery concerns will be an important consideration in seeking approval for any Columbia intake. As a new source, the Columbia would reduce the region's vulnerability to catastrophic events. Its location makes it particularly valuable as a back-up to the Bull Run source.

Aquifer Storage and Recovery

The major advantages of aquifer storage and recovery (ASR) are its low cost and its ability to augment summer supplies by making use of existing sources during the winter. This conjunctive use approach can delay or reduce the need for new sources. While large knowledge gaps still exist regarding ASR for this region, environmental impacts appear to be relatively minor, and water quality is assumed to be good based on current water quality in the region, technical analysis, and experiences elsewhere. The west side ASR representative site is close to Washington County's needs. The east side ASR site is close to the Clackamas County demands, and could also utilize existing Bull Run conduits and the Washington County Supply Line to serve the west side. As a new underground source, ASR would contribute to reducing vulnerability to catastrophic events.

Table XI-2, which duplicates Table VII-2, shows the ratings for each source option against each of the source-specific evaluation criteria.

Table XI-3 compares the costs of the source options. Some explanation is necessary to fully understand the figures in this table.

- Since the river diversions can be developed in stages, the costs for those source options are shown for some typical staging patterns. As described in the next paragraph, the costs for a particular size river intake/treatment plant will vary as a function of anticipated future stages of development for the same source option.
- The capital costs include all required source-related facilities. Depending on the source, this may consist of dams, headworks, wells, raw water intakes, pump stations, treatment plants, raw and finished water pipelines, and terminal reservoir capacity. For each stage, the capital costs of the source-related transmission lines that would be developed in conjunction with that stage are included. *For purposes of cost assessment, it is assumed that the transmission and terminal storage*

required for all stages would be developed in conjunction with the first stage.

- Operating costs are divided into:

a variable component, which depends on the quantity of water produced, and generally includes power, chemicals, and sludge disposal; and

a fixed component, which depends on the size of the facility, and includes the costs of labor and maintenance and supplies.

Table XI-2
RATINGS OF SOURCE OPTIONS
AGAINST SOURCE-SPECIFIC EVALUATION CRITERIA*

Source Option	Environment		Raw Water Quality			Aesthetics	Vulnerability to Catastrophic Events	Ease of Implementation
	Natural	Human	Comparative Rating	Watershed Protection				
Bull Run Dam 3	4.9	3.6	1.2	1	1	3.5	4.5	
Columbia	2.6	2.5	2.1	5	2.5	3.3	3.5	
Willamette	1	2.5	2.2	4	2	2.5	2.5	
Clackamas (up to 50 mgd)	1	1	1.8	2	2	2.5	2	
Clackamas (more than 50 mgd)	2.4	1	1.8	2	2	2.5	2	
ASR	1.5	2.2	3	NR**	3	NR**	3	

* Scale ranging from 1-5 with 1 as the most favorable rating and 5 as the least favorable rating.

** Not rated.

*** Score does not reflect potential to mitigate environmental impacts (e.g., fish resources) as was factored in for other options.

**Table XI-3
COSTS OF SOURCE OPTIONS FOR TYPICAL STAGING PATTERNS**

Source Option and Stage	Maximum Delivery Capacity (mgd)	Usable Storage Capacity (mg)	Capital Cost ²⁵ (\$million)	Variable Operating Cost ²⁶ (\$/mg)	Annual Fixed Operating Cost (\$/mgd/yr)
Bull Run Dam 3	270	19,000 ²⁷	\$509	\$5	\$19,000
Clackamas River					
Stage 1	50		\$153	\$173	\$59,400
Stage 2	33		\$ 30		\$25,000
Willamette River					
Stage 1	50		\$315	\$220	\$82,800
Stage 2	50		\$ 53		\$21,700
Columbia River					
Stage 1	50		\$198	\$246	\$49,900
Stage 2	25		\$ 17		\$20,000
Aquifer Storage & Recovery	40	4,800	\$ 32	\$421	\$35,900

²⁵Includes, where applicable, costs of dam, headworks, intake, treatment plant, required raw and treated water pipelines, and terminal storage. Costs expressed in 1994 dollars.

²⁶Includes costs of chemicals and power.

²⁷Usable storage capacity for Bull Run Dam 3 assumes no filtration.

Conservation

Each resource strategy begins by implementing some conservation programs. The savings associated with the programs ramp up over a period of years as program penetration rates increase. Chapter IX describes the regional conservation planning component of the RWSP, which undertook a detailed analysis of a wide variety of conservation programs. Based on that analysis, regional providers must determine the most appropriate set of programs and a detailed implementation plan.

The strategies are configured to illustrate the value of different types of conservation to the region. The key distinction is between the efficacy of focusing primarily on "outdoor" conservation and implementing a wide range of both indoor and outdoor conservation programs (so-called "maximum" conservation).²⁸ "Outdoor" conservation would result in a reduction in peak-day demand of about 94 mgd by the year 2050 assuming high population growth and associated demand. "Maximum" conservation would increase this figure to 120 mgd.

Four of the five resource strategies presented later in the chapter focus on outdoor conservation programs due to their substantial cost-effectiveness relative to indoor programs. Initial program development would involve enhanced conservation education. More substantial savings are projected to be achieved with the implementation of audits and incentive programs to reduce outdoor water use, along with more aggressive conservation pricing.

Both "outdoor" and "maximum" conservation packages include landscape ordinances for new development. Such ordinances provide an inexpensive way to phase in a large amount of peak-season conservation over time. However, these programs are often controversial and difficult to implement. Some portions of the region may implement these programs earlier, while others may implement them later or not at all. The extent and timing of landscape ordinances throughout the region are issues that must be carefully addressed by the providers. Depending on the outcome of these deliberations, the timing of required supply additions may have to be moved forward.²⁹

²⁸The "maximum" conservation package, as its name suggests, includes all conservation programs identified in Chapter IX. It is designed to show the limits of contributions that conservation can make to the region. The "outdoor" conservation programs include:

- Conservation education
- Residential, commercial, industrial, and large landscape audits
- Residential, commercial, and industrial landscaping and irrigation incentives
- Residential, commercial, and industrial landscape ordinances
- Conservation pricing

²⁹For example, under high demand assumptions, without implementing any new conservation programs, the need for a new supply increment would be moved forward by about six to seven years.

RESOURCE STRATEGIES

Strategy Development

There are many ways for the region to add resources and facilities to maintain particular levels of reliability. The choice among these different strategies depends on which policy objectives are considered most important. The strategies are “thematic” in the sense that each is designed to emphasize a specific policy objective or set of objectives. (For example, one strategy may be designed to emphasize the objectives of minimizing environmental impacts and efficient use of water. Another might focus on cost minimization and raw water quality.) The essence of integrated resource planning lies in making tradeoffs among conflicting policy objectives. The strategies developed in this chapter are intended to represent key tradeoffs that face regional policymakers. Choices must be based on these tradeoffs.

The following is a discussion of five approaches to meeting the region's needs that were developed in preparation of the Preliminary RWSP. Each of these five strategies emphasizes different policy objectives or combinations of objectives. Table XI-4 provides a guide to the key policy objectives emphasized in each strategy. The resource strategies are intended to span the range of approaches the region can take if specified objective(s) are emphasized. From evaluation and public review of these strategies, hybrid strategies have emerged to reflect the region's priority (see Chapter XII).

Table XI-4
KEY POLICY OBJECTIVES
ADDRESSED BY RESOURCE STRATEGIES

Strategy	Natural Environment	Water Use Efficiency	Raw Water Quality	Costs	Catastrophic Events
1	✓	✓			
2		✓	✓		
3		✓	✓	✓	
4		✓			✓
5	✓	✓		✓	✓

Following is a description of the general approach used to develop all five strategies, including the principles that guided the additions of resources and transmission facilities.

Each of the five strategies begins with a specified combination of conservation programs. Because of the importance assigned throughout the region to conservation by stakeholders, policymakers, and the public at large, conservation is always assumed to be a starting point, regardless of demand or the chosen reliability level. Then, for each level of demand (high, medium, and low), the timing of supply and transmission additions was determined by the specified level of reliability. System additions were made in the year that, but for that addition, reliability would have fallen below the chosen level. For example, for Level 1 reliability, supply and/or transmission was added in the first year that any shortage was observed with base case resources and facilities.

Each strategy attempts to defer the need for new supplies by first adding transmission capacity between and/or within nodes to ameliorate shortages before they exceed what is allowed by the assumed reliability level. New supplies are added only when necessary and are accompanied by the minimum necessary inter-nodal transmission capacity to move the new supply to the appropriate demand node(s). The order and magnitude of supply additions are determined by the policy objectives that the strategy is seeking to emphasize and the amount of delivery capacity available from each source.

In some cases, the timing of the source-related inter-nodal and intra-nodal transmission enhancements is accelerated to reflect the need to serve local demands prior to the addition of the new supply source. Such accelerated transmission additions between the nodes are arbitrarily assumed to occur in 2010. (Local transmission in certain portions of the region may be needed sooner.)

Inter-nodal transmission may also be added for catastrophic event protection. In strategies for which protection against catastrophic events is an important objective (i.e. Strategies 4 and 5), transmission is added solely for the purpose of providing redundant service to a portion of the region in the event that one or more supply sources are disrupted. The timing of such additions of transmission is independent of any supply addition. In order to get the benefits of such redundancy early in the planning period, all such additions are assumed to be on-line in the year 2010.

Addressing Uncertainties

For a resource plan to be useful to the region's policymakers and water agency managers, it must be dynamic and must account explicitly for the region's future uncertainties. The plan must provide guidance regarding future resource development as those uncertainties are resolved.

As mentioned above, a *resource strategy* includes combinations of conservation, supply, and transmission options, and defines actions that should be taken recognizing various sets of uncertainties. It provides a "road map" of recommended actions given a wide range of future conditions, and a series of points at which the region can respond to new information about then-current conditions.

Figure XI-6, a generic illustration of a resource strategy, shows many of the key issues that will influence the region's decisions and actions over time. This figure reflects the fact that we have limited knowledge about many important factors associated with each source option. These include (but are not limited to) costs, construction lead times, ability to obtain permits, legal and regulatory constraints, institutional structures, and public acceptability. In the extreme, any one or more of these issues could impede or prevent the region from developing a particular source option, facility or program. At the very least, differing outcomes will affect various source options' relative attractiveness.

Conservation also has associated major cost and impact uncertainties. Potential savings along with the sustainability of behavior changes are hard to predict.

One of the most critical areas of uncertainty is the base demand forecast itself. In many ways, the demand forecast underlies the entire planning effort. Yet, the forecast depends on a number of difficult to determine components, such as regional population and employment growth, the spatial distribution of that growth, the impacts of naturally occurring conservation and rising water and sewer prices, the responsiveness of demand to variations in temperature and precipitation, and the relationship between average and peak day demands.

Resource strategies must balance the coverage of all possible future uncertainties with policymakers' and managers' need for a useable tool. The RWSP strategy design and analysis account for future uncertainties. Each strategy includes a series of future water demand assessments. Throughout the planning period, the region will have to repeatedly assess these demands and adjust its resource plan accordingly. The region will also have to proceed in light of other key uncertainties as well.

Figure XI-6
Generic Resource Strategy

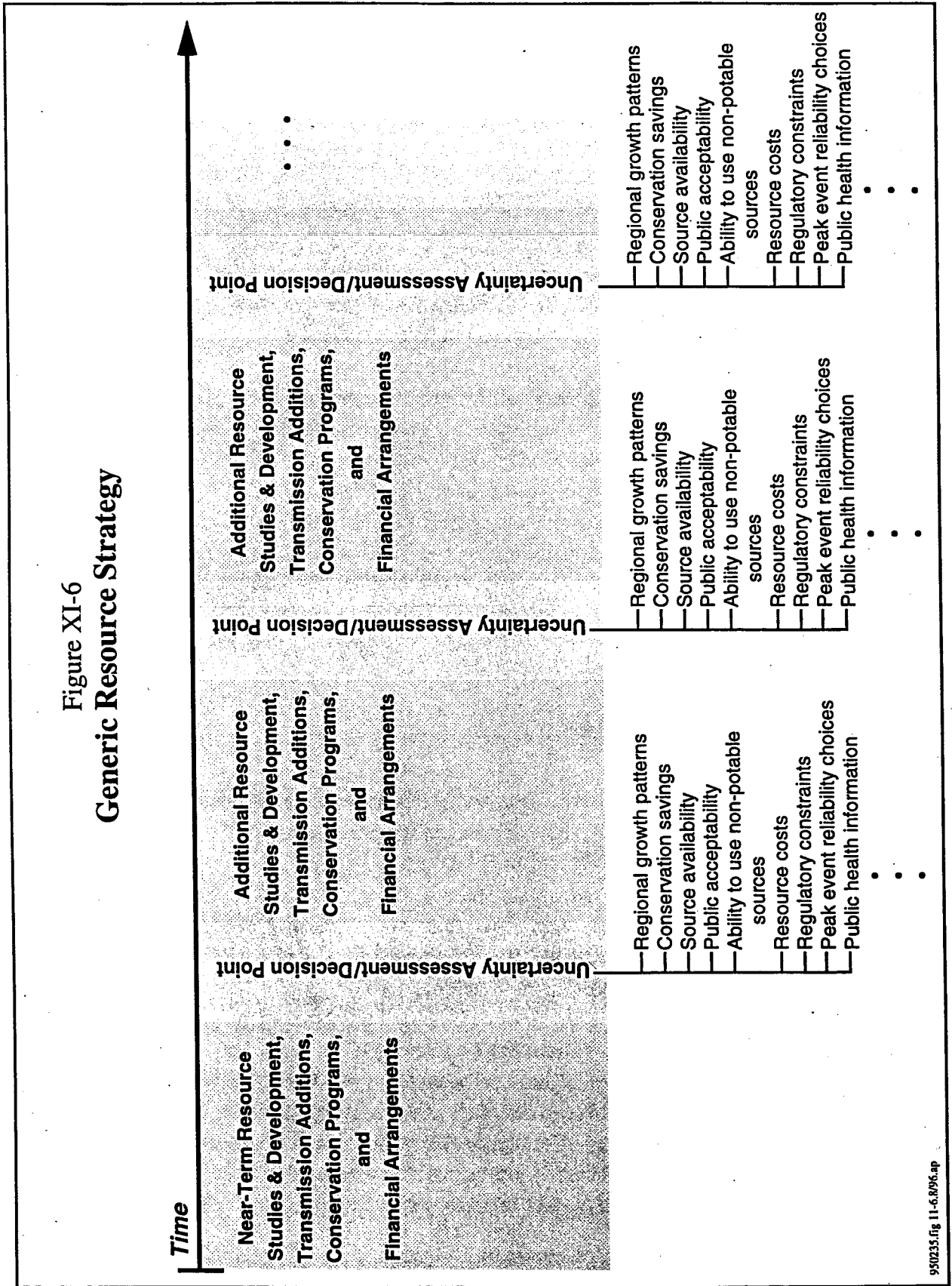

Characterization of Uncertainties: Demand, Flexibility, and Reliability Choices

Two types of strategy diagrams have been designed to depict each of the five resource strategies. Each diagram shows estimated construction and on-line dates for appropriate resources. These are dates at which resource additions would be necessary to maintain a selected level of reliability assuming high ("H"), medium ("M"), or low ("L") demands.

The "simplified" strategy diagrams show when various resource additions would need to be brought on-line given only a single initial demand assessment at the beginning of the planning horizon. These diagrams show the three resource development paths associated with a high, medium, or low demand scenario.³⁰ However, as discussed above, demand, along with a host of other uncertainties, will be repeatedly reassessed throughout the planning period so that the region will have the opportunity to adjust to the inevitable changes in growth and demand patterns that will occur.

The "detailed" resource strategy diagrams (or "decision-trees") reflect the need for ongoing assessment of uncertainties and also help to evaluate the flexibility of each strategy in dealing with future uncertainty. The related policy objective reads:

Maximize the ability to anticipate and respond to unforeseen future events or changes in forecasted trends.

The detailed diagrams provide a visual way to evaluate the extent that this flexibility objective is achieved. A resource strategy with more paths through it will be more flexible. Intuitively, one would expect strategies that rely on smaller and more diversified resource additions to be more flexible than those relying on larger increments. Such a strategy provides more options to tailor resource development to changes in the region's needs and other circumstances that may be difficult to predict or control. The strategy diagrams bear this out. For example, Strategy 2, which relies on a single large resource addition (Bull Run Dam 3), has many fewer possible paths than, say, Strategy 5, which relies on up to four smaller additions.

The detailed diagrams show the decision points and alternative resource development paths given ongoing reassessments of demand and other uncertainties. They depict the multiple future resource paths the region could take depending on whether future demands are high, medium, or low. Demand is shown to be reassessed at intervals

³⁰The simplified diagrams also show transmission additions. Due to space limitations, transmission additions are not included in the detailed diagrams.

corresponding to the earliest points at which changes in assumed demands could affect resource development paths.

It should be noted, however, that demand reassessments should be routinely done more often than indicated in these diagrams—probably at least as often as every five years. As discussed in Chapter V, many uncertainties are associated with the Metro growth forecasts and with the conversion of those forecasts into annual, seasonal, and peak-day water demand forecasts. The possibility of future demands exceeding our “high” forecast cannot be discounted. Frequent demand reassessments will ensure the region is not “caught by surprise” should such demand growth occur.

For three of the strategies, both the simplified and detailed diagrams illustrate the resource additions that would be required to maintain Level 1 reliability. However, the choice of different reliability levels will also affect the timing of these additions. This impact is illustrated graphically for two of the resource strategies (2 and 5). Those diagrams show that if the region ultimately chooses a lower level of reliability, resource additions would be deferred and particular additions might not be required at all during the planning period, regardless of the regional demand.

As mentioned earlier, besides reliability choices, many future uncertainties exist in addition to demands. For example, each of the source options could encounter permitting or other difficulties that result in an inability to develop the option. In such instances, alternative sources would have to be substituted as the plan is updated. Such updates must reflect the best available information on source implementation prospects.

The five strategies are now presented below. The strategies are assigned numbers one through five. (In the preliminary plan these strategies were numbered 1.1 through 1.5.) The policy objectives associated with each of the strategies have also been refined as described in Chapters IV and XII.

Strategy 1

The following policy objectives are emphasized in this strategy, which is illustrated in Figures XI-7 and XI-8:

- *Environmental Impact*

Minimize the impact of water resource development on the natural environment.

■ *Efficient Use of Water*

Maximize the efficient use of water resources, taking into account current and emerging conservation opportunities, availability of supplies, practicality, and relative cost-effectiveness of the options.

Make best use of available supplies before developing new ones.

As the regional objectives of environmental protection and resource efficiency are emphasized, conservation and the Willamette are the two resources relied upon. Conservation contributes to both objectives as a resource that can delay and reduce the development of new supplies and associated environmental impacts. Among supply sources, the development of the Willamette is expected to have the least environmental impact.

Under this approach, the region would implement all the conservation programs described in Chapter IX, and then as needed would develop sufficient capacity on the Willamette in stages to achieve the chosen level of reliability. As shown in Figure XI-7, the region would also develop the necessary transmission capacity to move the water where it is needed.

Figure XI-7
Resource Strategy 1: Simplified Version*

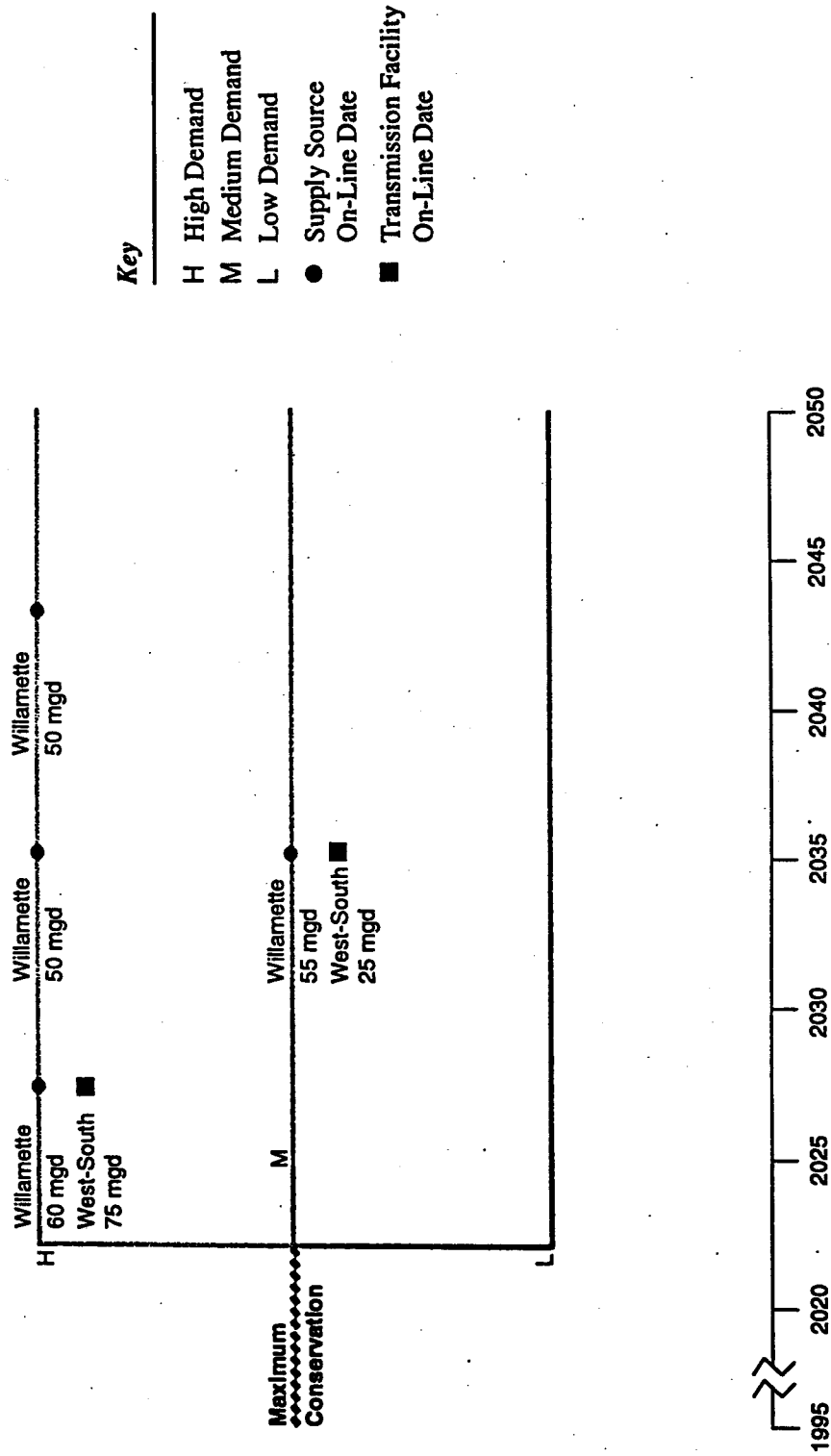

*Assuming Level 1 Reliability

Figure XI-8

Resource Strategy 1: Detailed Version*

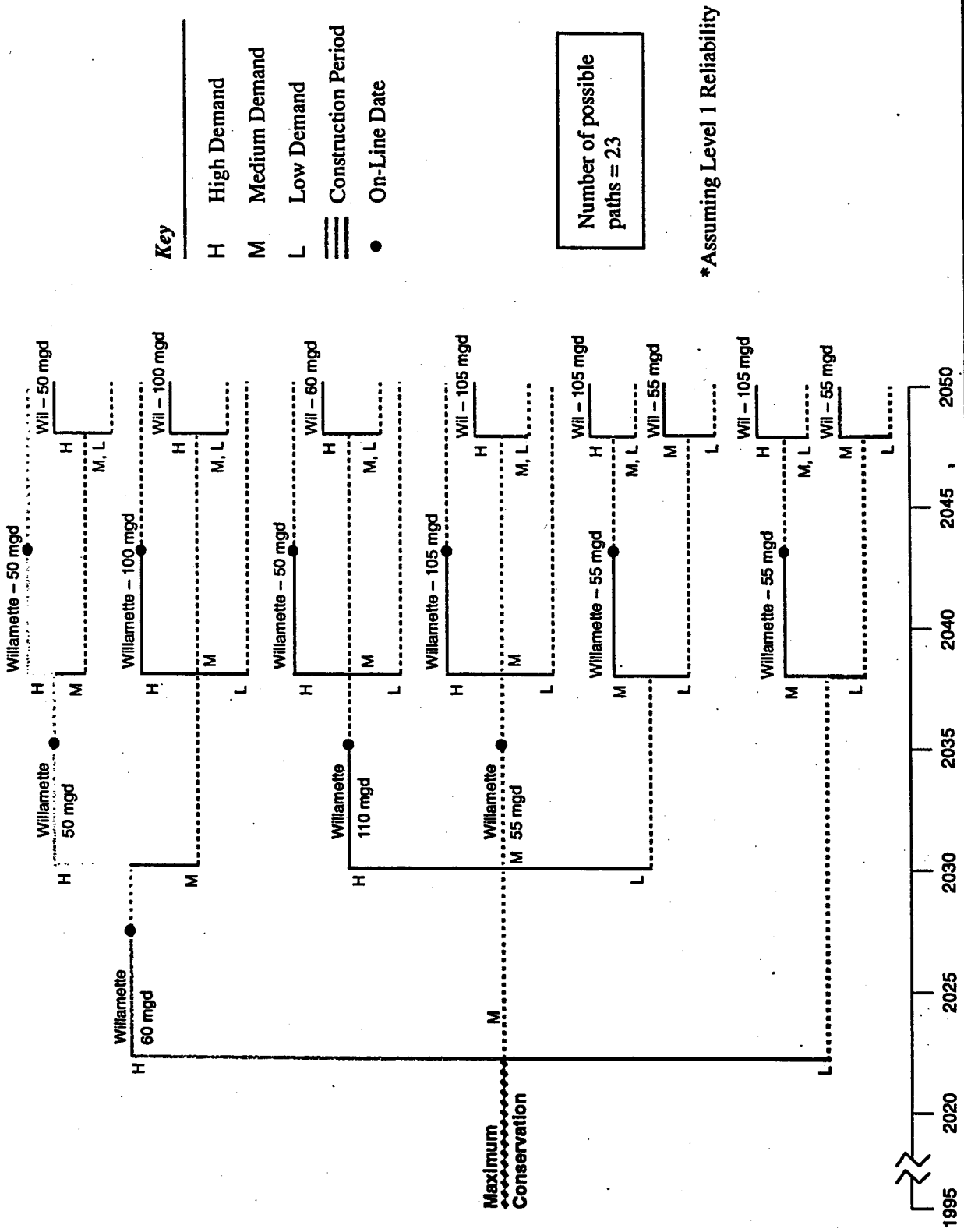

Strategy 2

This strategy, which is illustrated in Figures XI-9 and XI-10, stresses the objectives of maximizing raw water quality and water use efficiency, as follows:

- **Raw Water Quality**

Maximize the ability to protect water quality in the future, including the ability to use watershed-protection based approaches.

Utilize sources with highest raw water quality.

- **Efficient use of water**

Maximize the efficient use of water resources, taking into account current and emerging conservation opportunities, availability of supplies, practicality, and relative cost-effectiveness of the options.

Make best use of available supplies before developing new ones.

To meet these regional priorities, the region must turn to conservation and the Bull Run. The efficiency objective is addressed through some implementation of conservation programs, namely those targeted to outdoor use. As indicated, close to 80% of the potential peak demand reductions resulting from conservation programs are associated with the outdoor programs. The cost to achieve the last 20% of peak-day savings is extremely high. Due to the capacity-constrained nature of the regional system, outdoor conservation programs are much more cost-effective to the region than are indoor programs.

The Bull Run's raw water quality is superior to other sources in the region. The protected nature of its watershed is also an important advantage in maintaining that high quality in the future. Thus, the preferred source option for this strategy is Bull Run Dam 3. Additional transmission capacity is required to move Bull Run water to demands in the west and south nodes.

Figure XI-9
Resource Strategy 2: Simplified Version
(Showing Impacts of Different Reliability Levels)

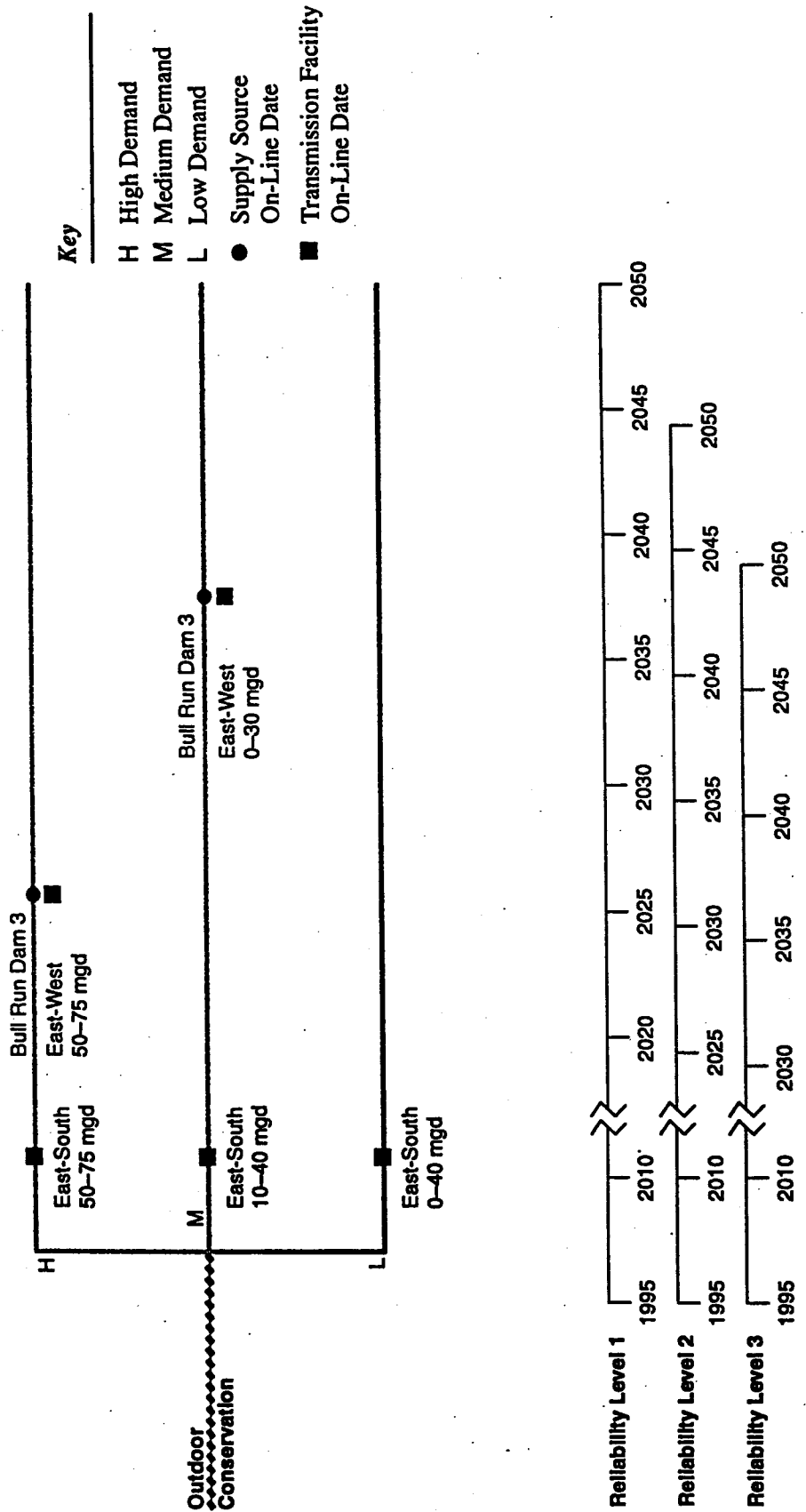
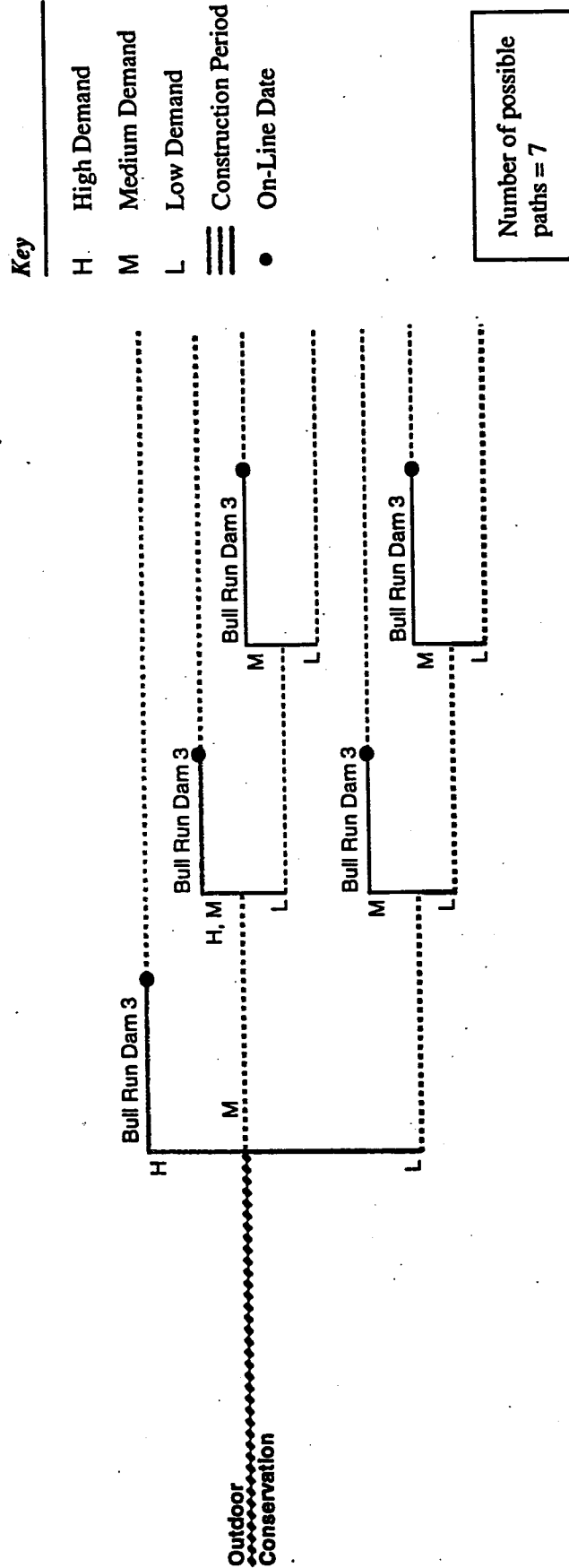

Figure XI-10
Resource Strategy 2: Detailed Version
(Showing Impacts of Different Reliability Levels)



Strategy 3

As in Strategy 2, this strategy stresses efficiency and raw water quality. However, it attempts to soften the adverse cost and environmental impact associated with Strategy 2. Strategy 3 is illustrated in Figures XI-11 and XI-12. The key policy objectives emphasized include:

- ***Economic Costs***

Minimize the economic impact of capital and operating costs of new water resources on customers.

- ***Efficient Use of Water***

Maximize the efficient use of water resources, taking into account current and emerging conservation opportunities, availability of supplies, practicality, and relative cost-effectiveness of the options.

Make best use of available supplies before developing new ones.

- ***Raw Water Quality.***

Maximize the ability to protect water quality in the future, including the ability to use watershed-protection based approaches.

Utilize sources with highest raw water quality.

Like Strategy 2, Strategy 3 includes key outdoor conservation programs. However, rather than developing Bull Run Dam 3, this strategy relies on maximum development of the Clackamas source as well as development of the Columbia source. The Clackamas has very high raw water quality, although not as high as the Bull Run. The upstream watershed is also more easily managed than the Willamette and Columbia options. A Clackamas increment is also less costly than the Bull Run option. As discussed in Chapter VII, the Columbia's raw water quality is judged to be somewhat better than that of the Willamette.

Strategy 4

This strategy, shown in Figures XI-13 and XI-14, emphasizes the desire to minimize the region's vulnerability to catastrophic events and the importance of water use efficiency. The specific objectives underscored are:

Figure 11

Resource Strategy 3: Simplified Version*

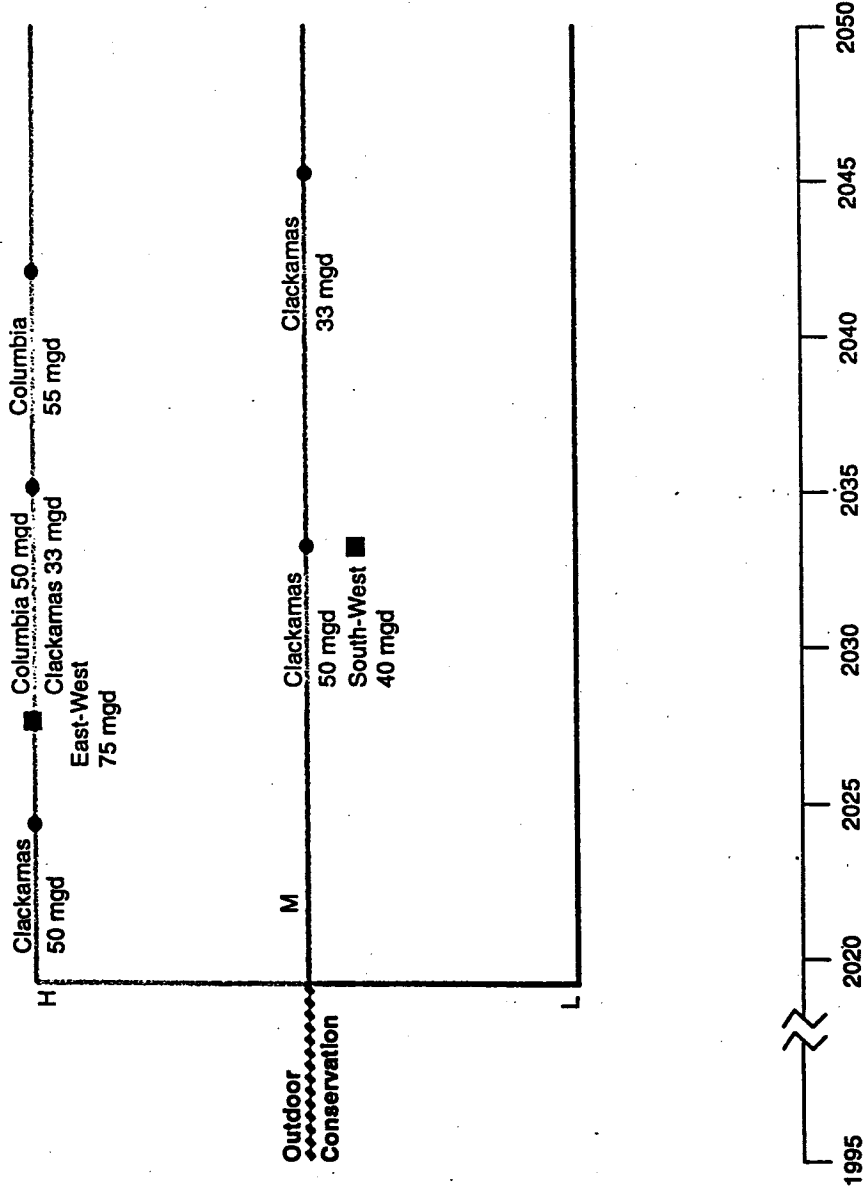

- Key**
- H High Demand
 - M Medium Demand
 - L Low Demand
 - Supply Source
 - On-Line Date
 - Transmission Facility
 - On-Line Date

*Assuming Level 1 Reliability

Figure XI-12

Resource Strategy 3: Detailed Version*

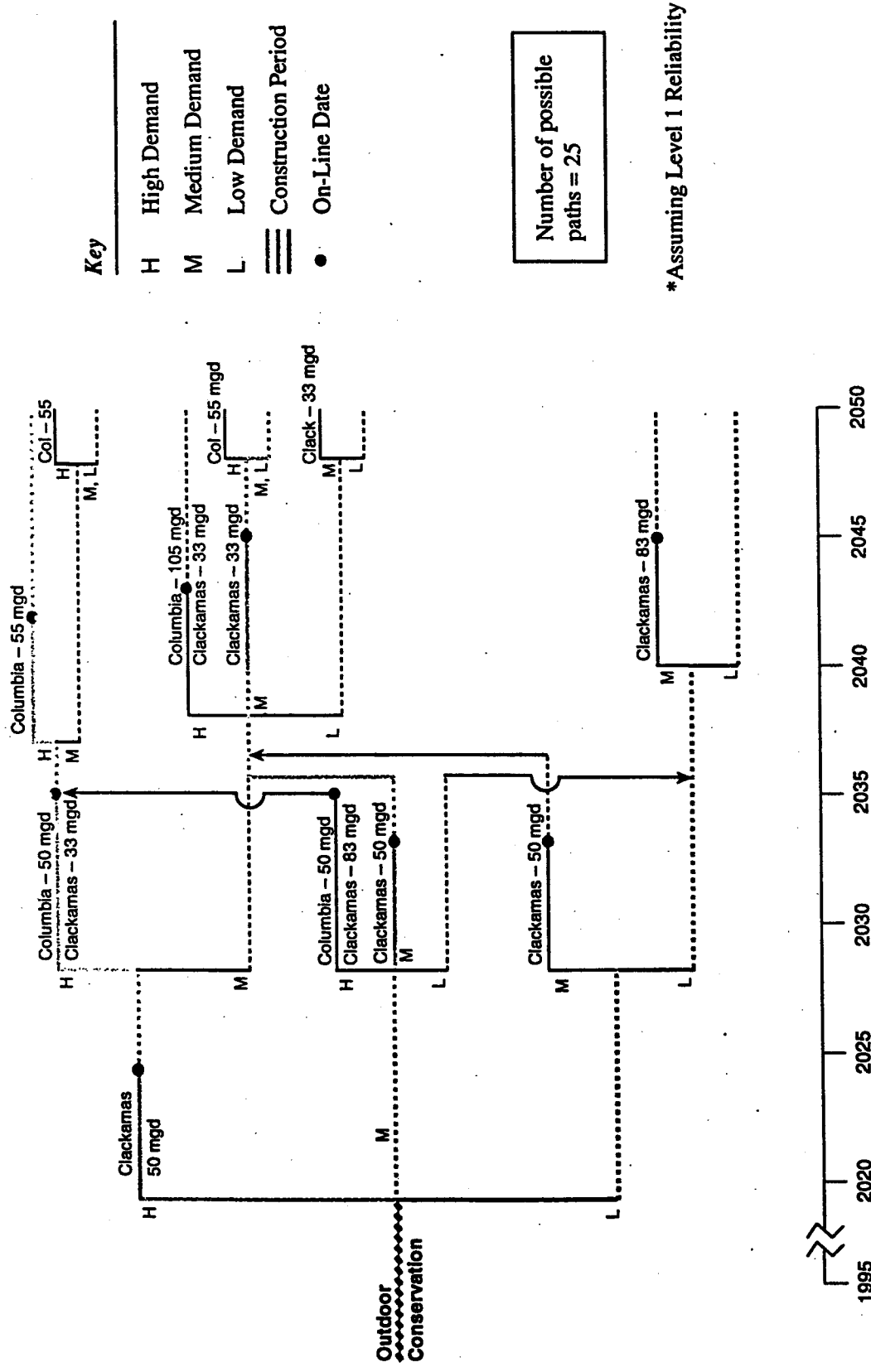
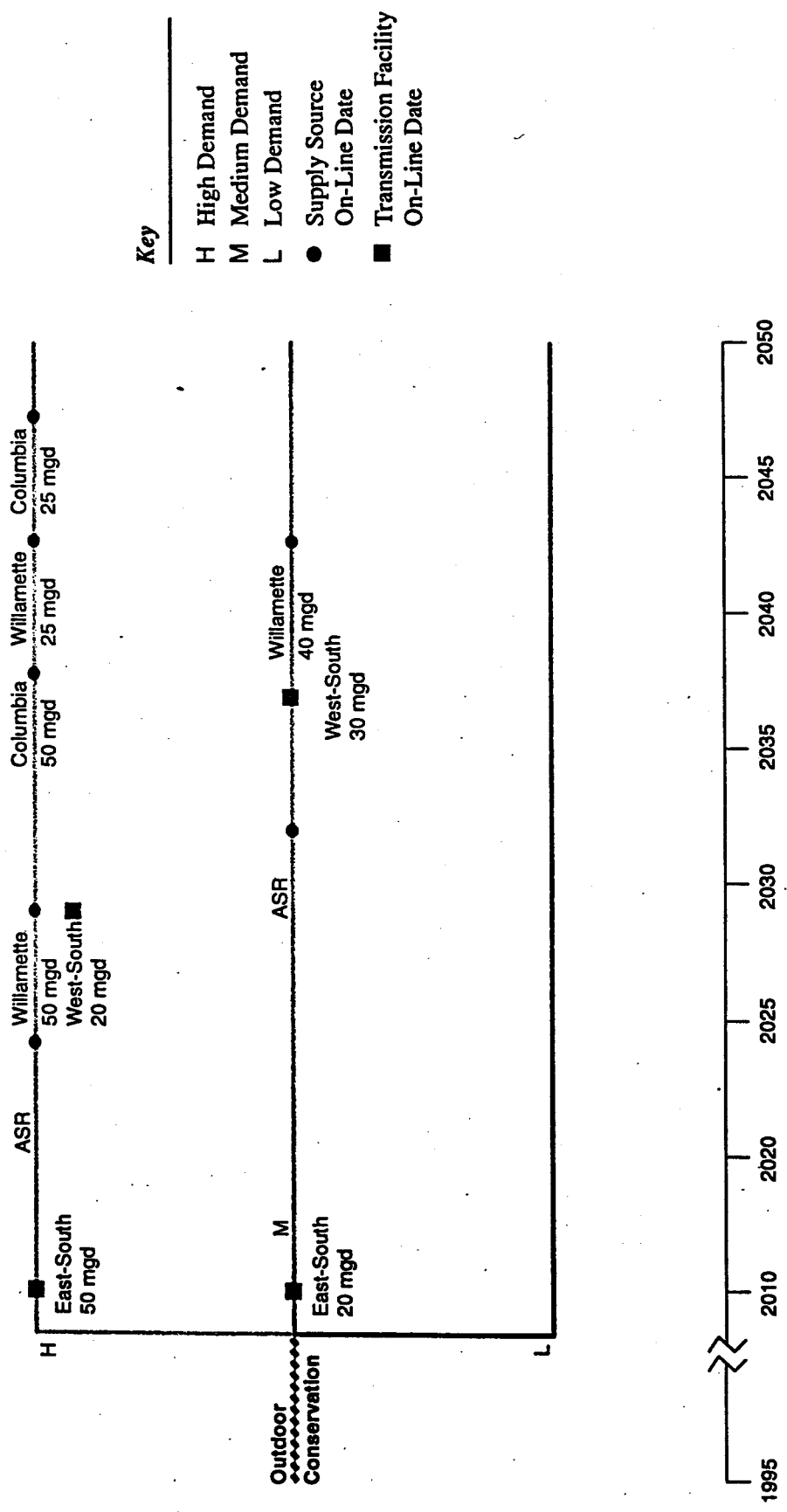

Figure XI-13
Resource Strategy 4: Simplified Version*



*Assuming Level 1 Reliability

Figure XI-14

Resource Strategy 4: Detailed Version*

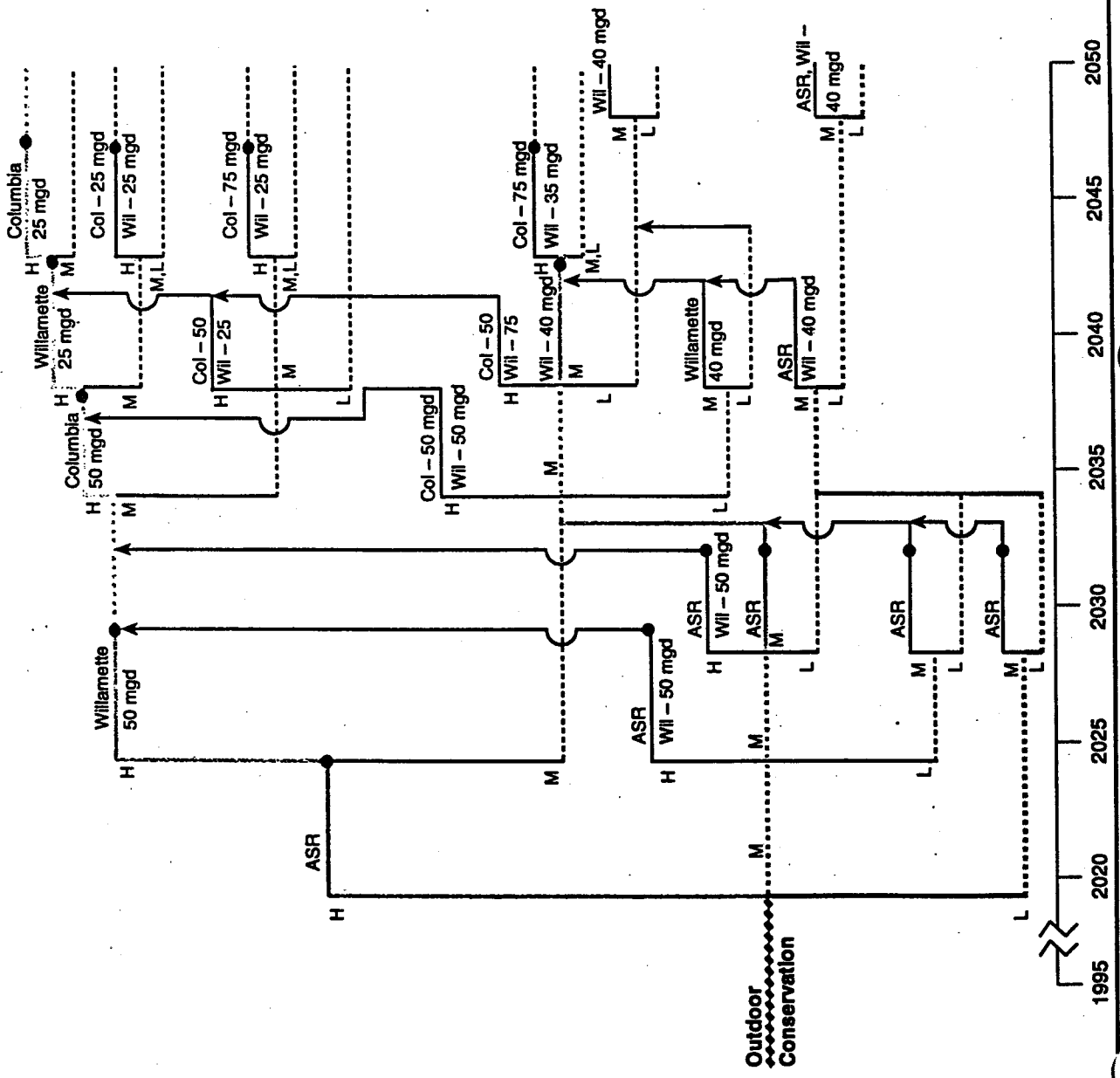

Key

- H High Demand
- M Medium Demand
- L Low Demand
- ▨ Construction Period
- On-Line Date

Number of possible paths = 95

* Assuming Level 1 Reliability

- ***Impacts of Catastrophic Events***

Minimize the magnitude, frequency, and duration of service interruptions due to natural or human-caused catastrophes, such as earthquakes, landslides, volcanic eruptions, floods, spills, fires, sabotage, etc.

- ***Efficient Use of Water***

Maximize the efficient use of water resources, taking into account current and emerging conservation opportunities, availability of supplies, practicality, and relative cost-effectiveness of the options.

Make best use of available supplies before developing new ones.

Strategy 4 includes outdoor conservation programs. In addition, vulnerability to catastrophic events is reduced by developing three new sources: ASR, the Willamette, and the Columbia. As new development occurs on the Clackamas River, transmission will be required from both east and west so Clackamas demand can be fully served by Bull Run, Columbia, and Willamette supplies.

Strategy 5

This strategy, which is illustrated in Figures XI-15 and XI-16, seeks to balance the policy objectives relating to environmental protection, efficiency, reducing catastrophic event vulnerability, and cost minimization. Thus, the strategy seeks to achieve the following objectives:

- ***Environmental Impact***

Minimize the impact of water resource development on the natural environment.

- ***Efficient Use of Water***

Maximize the efficient use of water resources, taking into account current and emerging conservation opportunities, availability of supplies, practicality, and relative cost-effectiveness of the options.

Make best use of available supplies before developing new ones.

- ***Impacts of Catastrophic Events***

Minimize the magnitude, frequency, and duration of service interruptions due to natural or human-caused catastrophes, such as earthquakes, landslides, volcanic eruptions, floods, spills, fires, sabotage, etc.

- ***Economic Costs***

Minimize the economic impact of capital and operating costs of new water resources on customers.

The key difference between this strategy and Strategy 4 lies in the substitution of the Clackamas source for the Columbia. This reduces the source diversity somewhat, as only two new sources would be developed rather than three. Environmental impacts would be reduced as the level of supply development proposed for all the sources in this strategy are expected to have relatively minor impacts on the natural environment. Although less transmission development than in Strategy 4 would be required to meet the expected needs of the Clackamas basin, a south-east transmission link would be added primarily to reduce vulnerability to catastrophic events. This link would provide a back-up in the event of a loss of either the Bull Run or the Clackamas source.

Figure XI-15

Resource Strategy 5: Simplified Version (Showing Impacts of Different Reliability Levels)

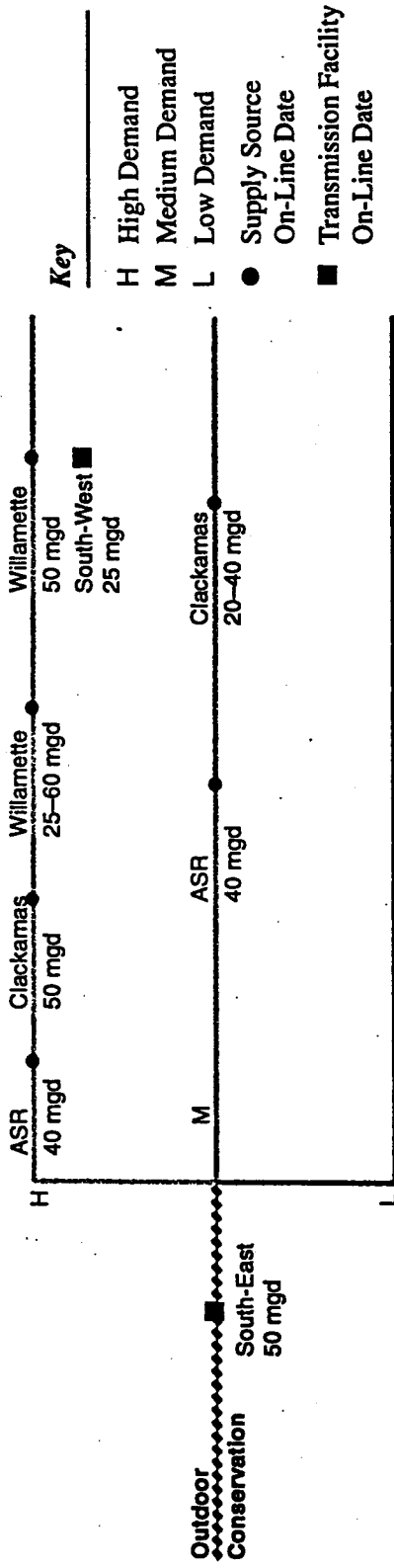
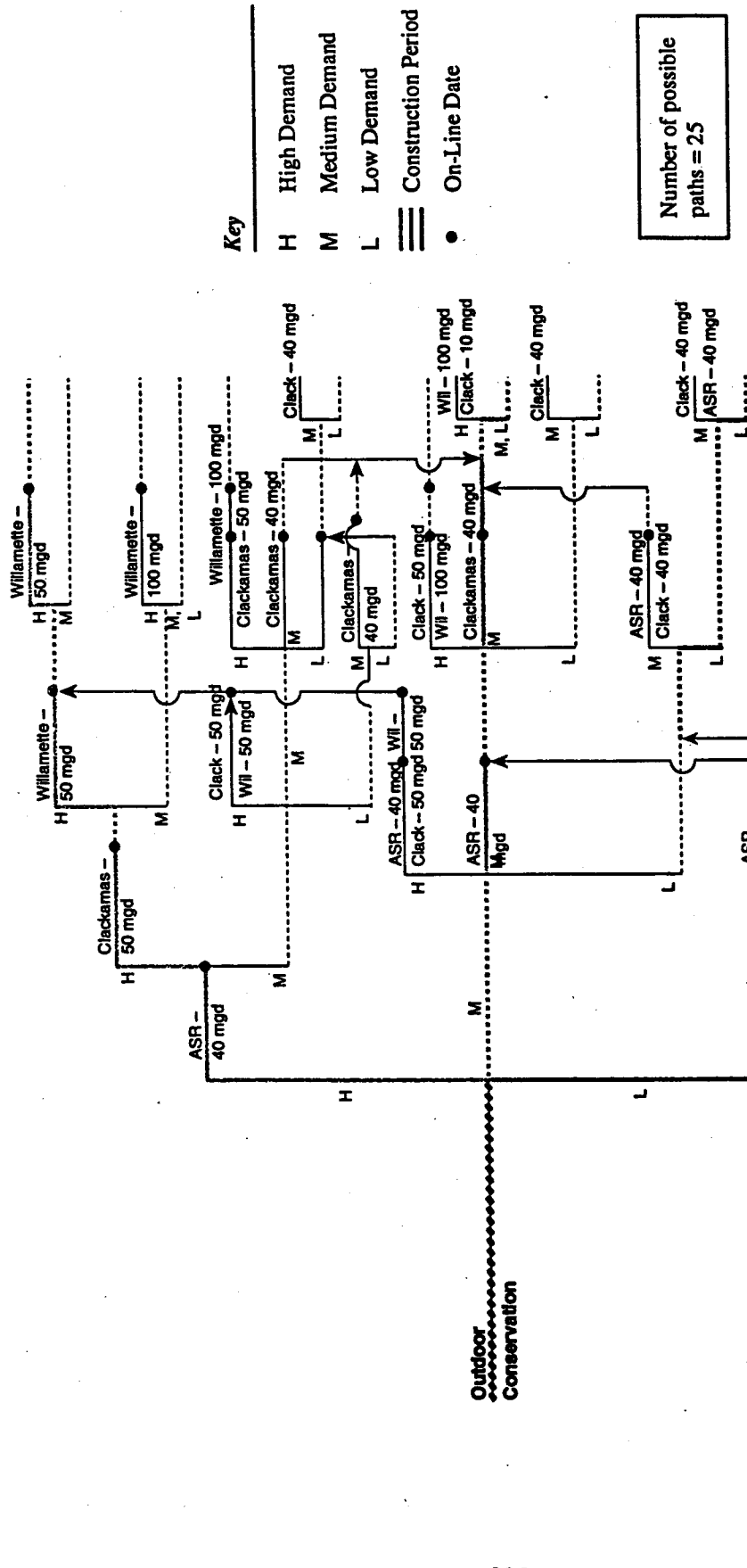

Figure XI-16

Resource Strategy 5: Simplified Version
(Showing Impacts of Different Reliability Levels)



Evaluation of Resource Strategies

The preceding discussion has laid out five potential resource strategies. Table XI-5 is a matrix of ratings against the key evaluation criteria (as defined in Chapter IV) for each strategy, assuming Level 1 reliability. The evaluation ratings would, of course, vary depending on the level(s) of reliability pursued by the region. Table XI-6 illustrates this potential variability for two of the strategies. Choosing different levels of reliability can influence cost as well as changing sizing or deferring the timing of new resource additions. The level and timing of environmental impacts can also be affected by chosen levels of reliability.

The scores in these tables are based on computed probabilities that a particular resource development path will be pursued. These computations are, in turn, based on assumed probabilities that different demand outcomes will occur, as shown in Table XI-7.

Table XI-5
EXPECTED VALUES OF KEY EVALUATION CRITERIA FOR RESOURCE STRATEGIES
 (Assumes Level 1 Reliability)

Strategy	Costs		Natural Environment*	Water Quality		Flexibility*
	Present Value Societal (\$million)	Present Value Utility (\$million)		Raw Water Quality*	Watershed Protection*	
Strategy 1 Natural Environment/Efficiency	864.3	797.8	1.0	2.0	1.8	3
Strategy 2 Raw Water Quality/Efficiency	580.6	619.9	4.1	1.2	1.2	5
Strategy 3 Costs/Water Quality/Efficiency	494.0	501.4	2.2	1.7	1.7	3
Strategy 4 Catastrophic Events/Efficiency	534.4	546.9	2.2	2.1	1.7	1
Strategy 5 Costs/Natural Environment/ Efficiency/Catastrophic Events	539.9	539.9	1.8	2.1	1.5	2

* Comparative scale ranging from 1-5 with 1 as the most favorable rating and 5 as the least favorable rating.

Table XI-6
EXPECTED VALUES OF KEY EVALUATION CRITERIA FOR RESOURCE STRATEGIES*
 (Assuming Levels 2 and 3 Reliability)

Strategy	Costs		Natural Environment**	Water Quality**		Flexibility**
	Present Value Societal (\$million)	Present Value Utility (\$million)		Raw Water Quality**	Watershed Protection**	
Level 2 Reliability:						
Strategy 2 Raw Water Quality/Efficiency	517.2	537.2	3.7	1.1	1.3	5
Strategy 5 Costs/Natural Environment/ Efficiency/Catastrophic Events	494.1	487.8	1.8	2.0	1.5	3
Level 3 Reliability:						
Strategy 2 Raw Water Quality/Efficiency	481.9	490.9	3.7	1.1	1.3	5
Strategy 5 Costs/Natural Environment/ Efficiency/Catastrophic Events	476.2	462.9	1.7	2.2	1.4	5

* Probability-weighted averages across all possible resource development paths.

** Scale ranging from 1-5 with 1 as the most favorable rating and 5 as the least favorable rating.

Table XI-7
ASSUMED PROBABILITIES OF DEMAND OUTCOMES

If Previous Demand Forecast Was:	Probabilities of Demand Outcomes in Next Forecast Are Assumed To Be:		
	High	Medium	Low
High	70%	30%	0
Medium	25%	50%	25%
Low	0	30%	70%

The key evaluation results for each strategy are discussed in additional detail below.

Strategy 1

This strategy was designed to maximize water use efficiency through conservation and minimize impacts to the natural environment. It does this, but at a high cost. The present value of the societal costs are far higher than the other strategies. This is due largely to the relatively high costs of particular (primarily indoor) conservation programs included in this strategy. Societal costs include costs to the utility that are reflected in rates. They also include significant out-of-pocket costs to customers for more efficient fixtures, appliances, and equipment. Table XI-8 illustrates the high cost of maximum conservation relative to the cost of focussing on outdoor conservation programs as assumed for the remainder of the strategies.

An alternative way to compare the economic impacts of different strategies is to focus on the amount by which customers' water bills would be higher than they otherwise would have been in the absence of any resource or facility development beyond the base case. Figure XI-17 shows the average monthly bill increase resulting from Strategy 1 for a typical residential customer using 8,000 gallons per month. These monthly bill increases climb to more than \$17 by the end of the planning period.³¹

³¹The estimated bill increases in Figures XI-17-21 assume high demands and Level 1 reliability. They are expressed in nominal (inflated) dollars and assume that annual revenue requirements are spread equally across all usage throughout the region. They also assume that all costs for each resource addition, including financing costs and other expenses, are passed through to ratepayers in the year that they are incurred.

Table XI-8

Expected Annualized Costs for Resource Strategies³²
(\$ millions)

Strategy	Capital Costs of Supply (Source Options & Transmission)	Operating Costs of Supply (Source Options & Transmission)	Conservation Costs (Capital & Administration) ³³	Total
1	\$9.6	\$11.5	\$14.9	\$36.0
2	\$14.8	\$11.6	\$11.6	\$38.0
3	\$9.3	\$11.2	\$11.6	\$32.1
4	\$10.4	\$11.1	\$11.6	\$33.1
5	\$9.3	\$12.1	\$11.6	\$33.0

³²Costs are expressed in constant 1994 dollars and are annualized over the entire planning period(i.e. through the year 2050). High demands and Level 1 reliability are assumed.

³³Conservation costs for all strategies include education.

Figure XI-17

Estimated Average Monthly Residential Bill Increases Due to Strategy 1

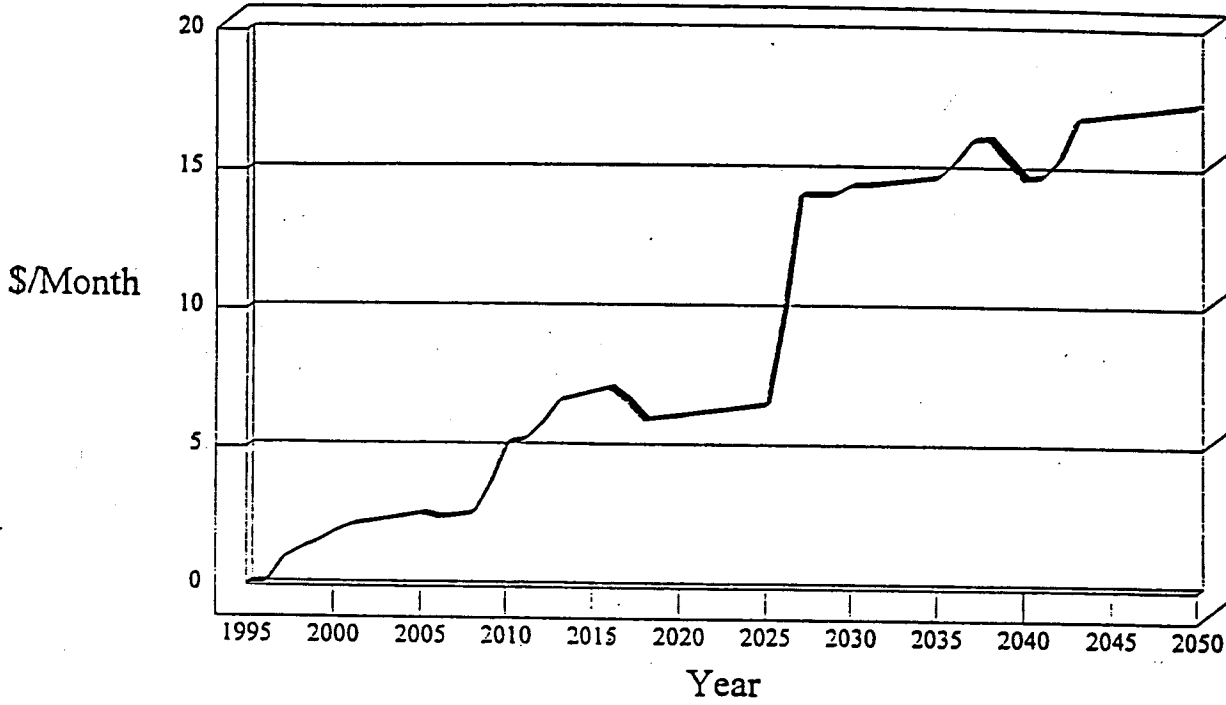

Notes:

Based on 8,000 gallon monthly consumption.
Impacts expressed in nominal (inflated) dollars.

Strategy 2

This strategy addresses goals of water use efficiency and raw water quality. It focuses on outdoor conservation which would accomplish significant water savings more cost effectively than the indoor programs included in Strategy 1. It relies on Bull Run Dam 3 as the single source of new supply in the region. The raw water quality is excellent, but costs are high in terms of dollars and potential environmental impacts. The region would also be relatively more vulnerable to a catastrophic event with increased proportional reliance on the Bull Run supply and out-of-basin importation. In addition, a relatively elaborate and complicated institutional structure and transmission system would be needed.

Figure XI-18 shows the typical residential monthly bill impacts. These impacts jump to \$15 when Dam 3 becomes operational, and slowly decline from that level (due to reduced operating costs and increasing regional demands over which debt service costs for Dam 3 are spread) over the remainder of the planning period.

Strategy 3

This is the lowest-cost strategy; it also has good raw water quality. Like Strategy 2, it improves water use efficiency in a cost-effective manner through implementation of outdoor conservation programs. Its environmental impacts are moderate. It adds a single new source of supply (the Columbia), leaving the region somewhat vulnerable to catastrophic events. Figure XI-19 indicates that the monthly bill impacts for a typical residential customer climb to almost \$14 by the end of the planning period.

Strategy 4

This strategy focuses on reducing the vulnerability to catastrophic events and improving water use efficiency. It adds three new sources of supply. This places the region in a much better position to withstand the catastrophic loss of any single source.

This approach also provides water use efficiency benefits from outdoor conservation and exhibits fairly low costs and moderate environmental impacts. As shown in Figure XI-20, the maximum monthly bill impact for a typical residential customer reaches \$14 by the end of the planning period.

Figure XI-18

Estimated Average Monthly Residential Bill Increase Due to Strategy 2

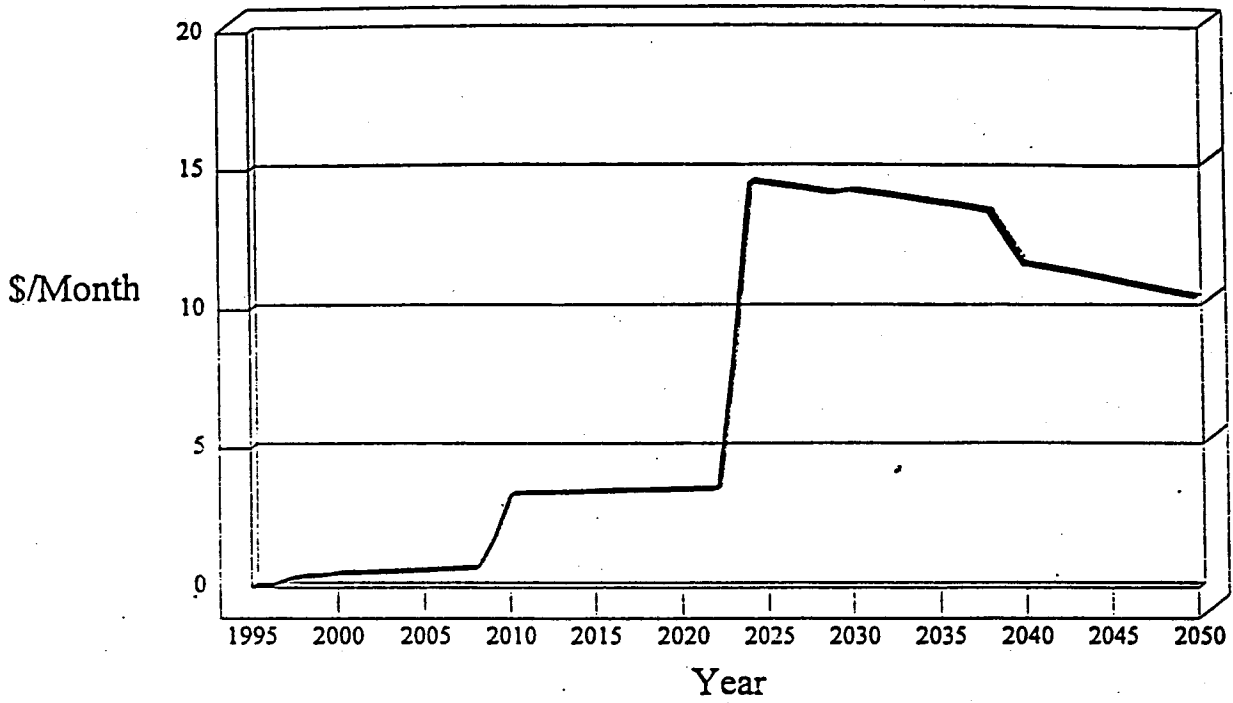

Notes:

Based on 8,000 gallon monthly consumption.
Impacts expressed in nominal (inflated) dollars.

Figure XI-19

Estimated Average Monthly Residential Bill Increase Due to Strategy 3

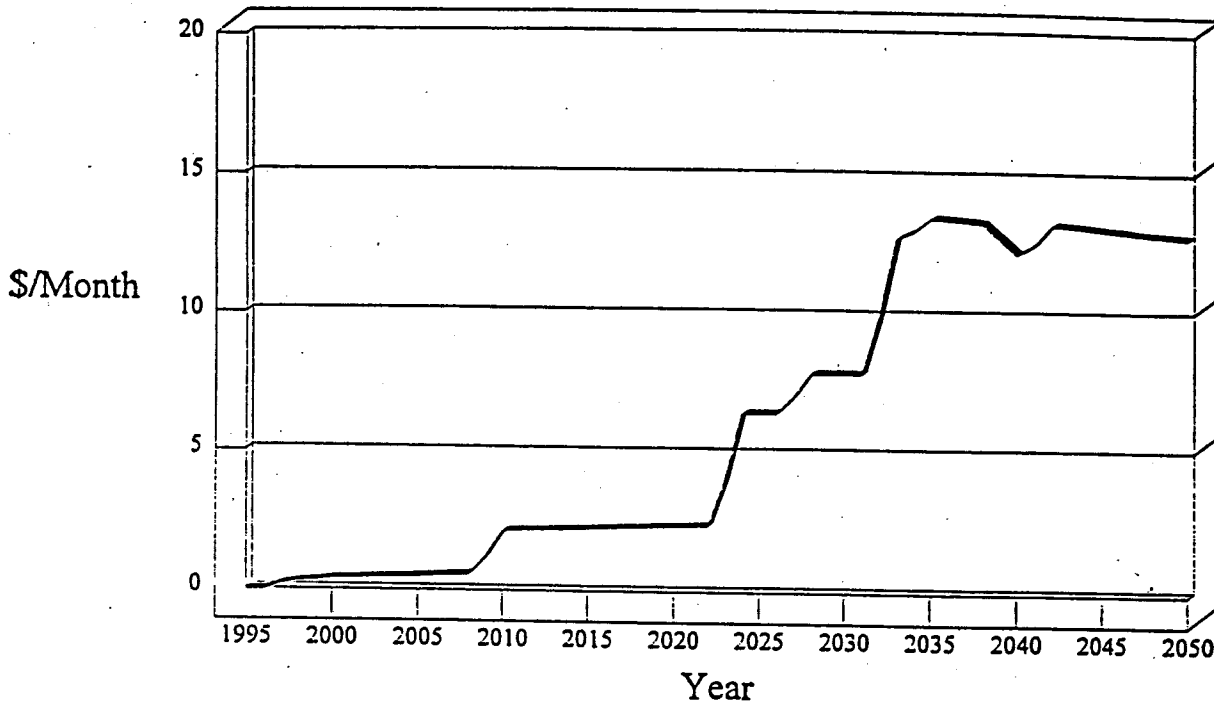

Notes:

Based on 8,000 gallon monthly consumption.
Impacts expressed in nominal (inflated) dollars.

Figure XI-20

Estimated Average Monthly Residential Bill Increase Due to Strategy 4

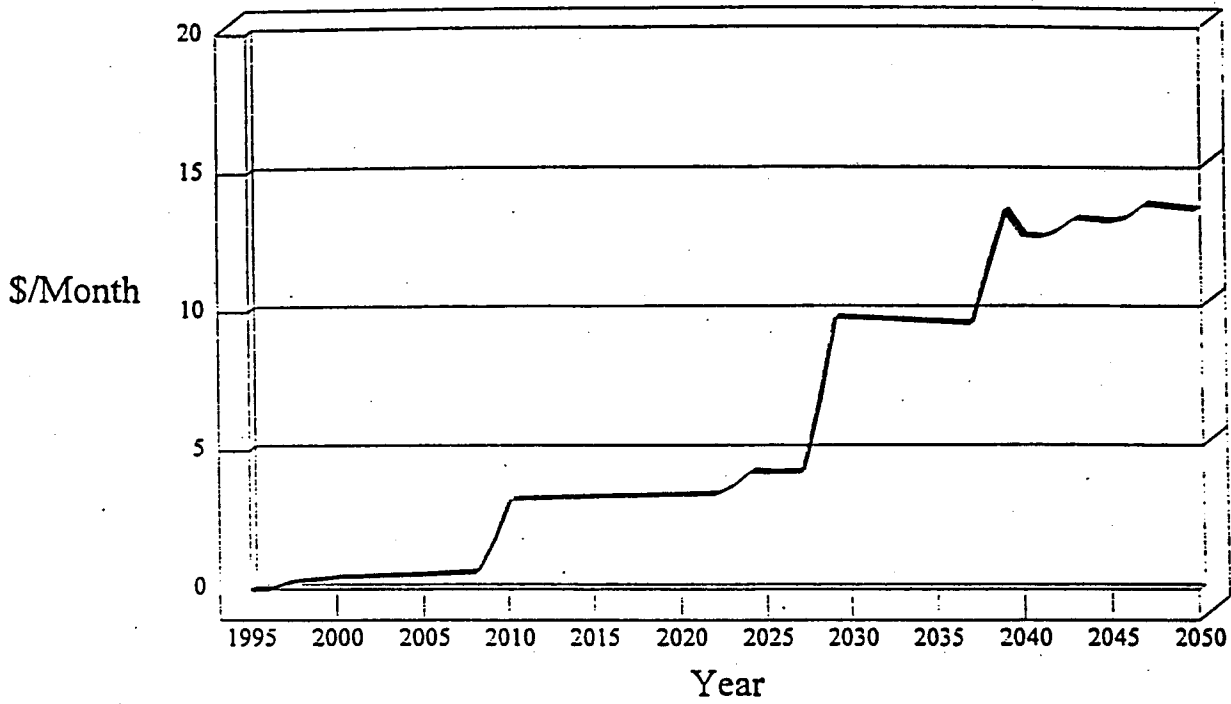

Notes:

Based on 8,000 gallon monthly consumption.
Impacts expressed in nominal (inflated) dollars.

Strategy 5

Strategy 5 rates well on environmental impacts, water use efficiency, raw water quality, watershed protection, and vulnerability to catastrophic events. Its costs are moderate, but comparable to Strategies 3 and 4.

Figure XI-21 indicates that residential bill impacts are also comparable to strategies 3 and 4. The maximum monthly bill increase, which occurs at the end of the planning period, is about \$12. Figures XI-22 and XI-23 show how rate impacts would vary if Levels 2 and 3 reliability were pursued respectively.

Each of these strategies is also rated for "ease of implementation." This rating, shown below in Table XI-9, is a composite of judgments regarding the anticipated regulatory and legal barriers to developing each component source option. Generally speaking, the higher the numerical rating, the higher the likelihood that such obstacles would prevent the strategy from being developed as set forth, and that substitutions would have to be made for one or more source options. A similar effect can result from varying degrees of future public acceptance of particular source options. As implementation issues become more apparent in the future, regional providers must determine which modifications, if any, must be made.

TABLE XI-9
EASE OF IMPLEMENTATION RATINGS
(for Simplified Strategies, Level 1 Reliability)

Strategy	1	2	3	4	5
Ease of Implementation Score*	2.5	4.5	3.1	3.8	3.3

* Scores range from 1 to 5. A higher score indicates a lower ease of implementation.

Figure XI-21

Estimated Average Monthly Residential Bill Increase Due to Strategy 5

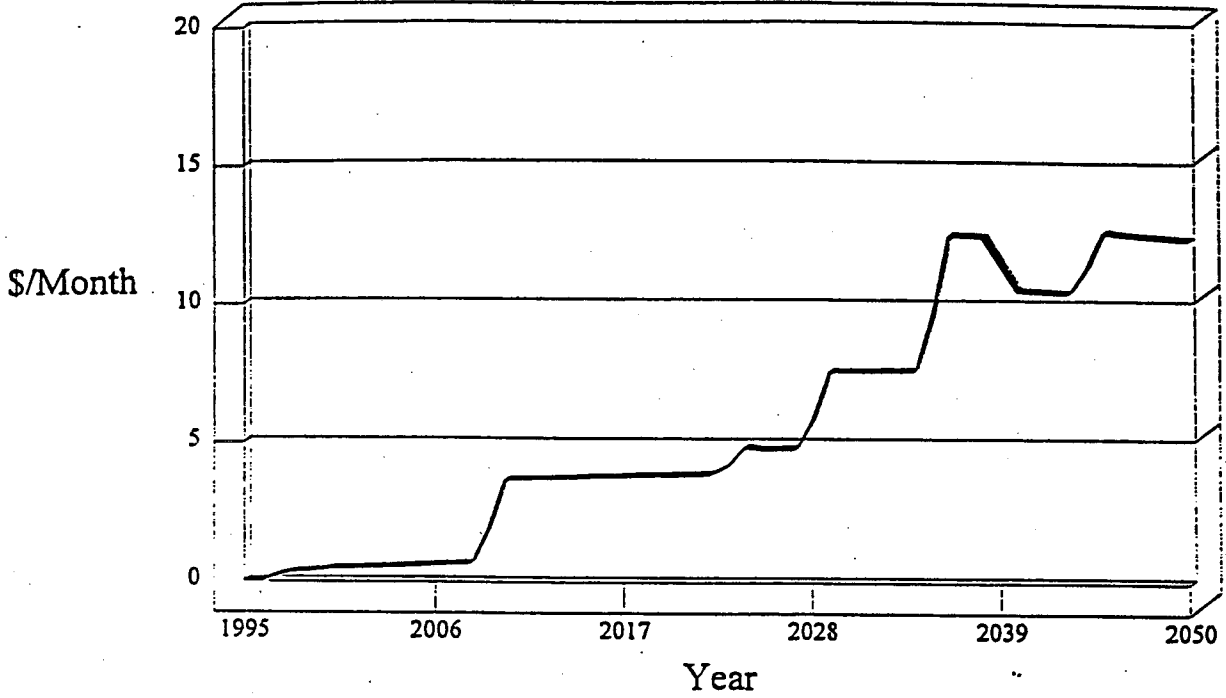

Notes:

Based on 8,000 gallon monthly consumption.
Impacts expressed in nominal (inflated) dollars.

Figure XI-22

Estimated Average Monthly Residential Bill Increase Due to Strategy 5 Reliability Level 2

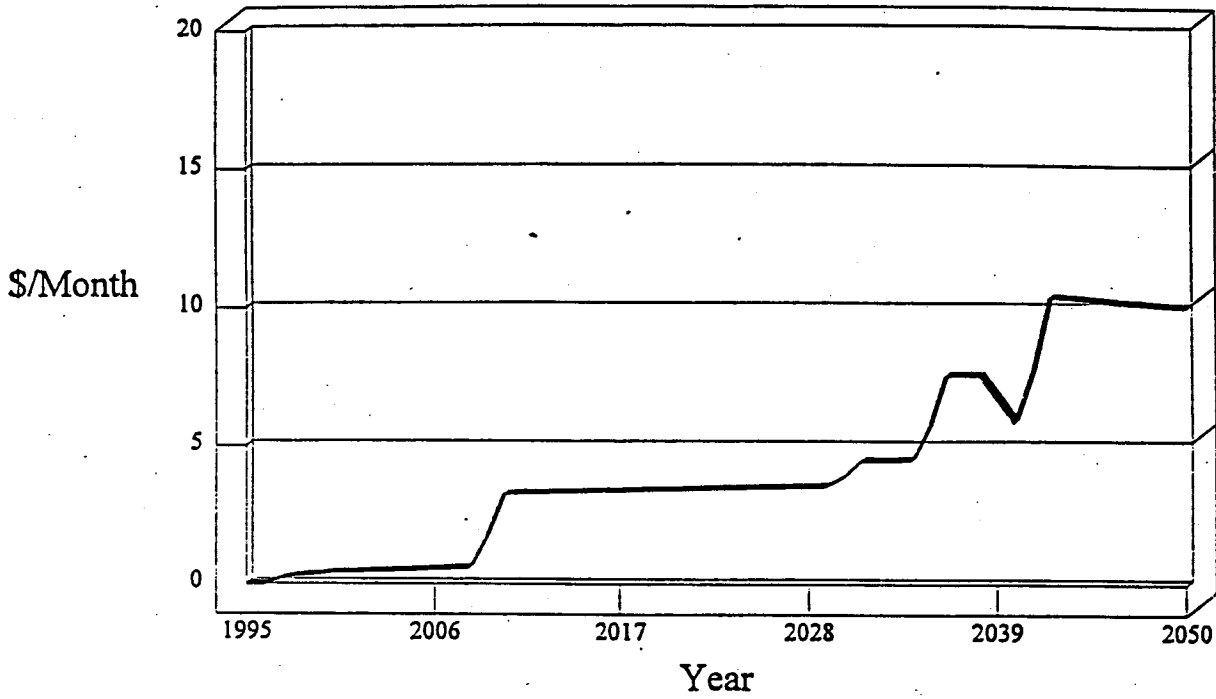

Notes:

Based on 8,000 gallon monthly consumption.
Impacts expressed in nominal (inflated) dollars.

Figure XI-23

Estimated Average Monthly Residential Bill Increase Due to Strategy 5 Reliability Level 3

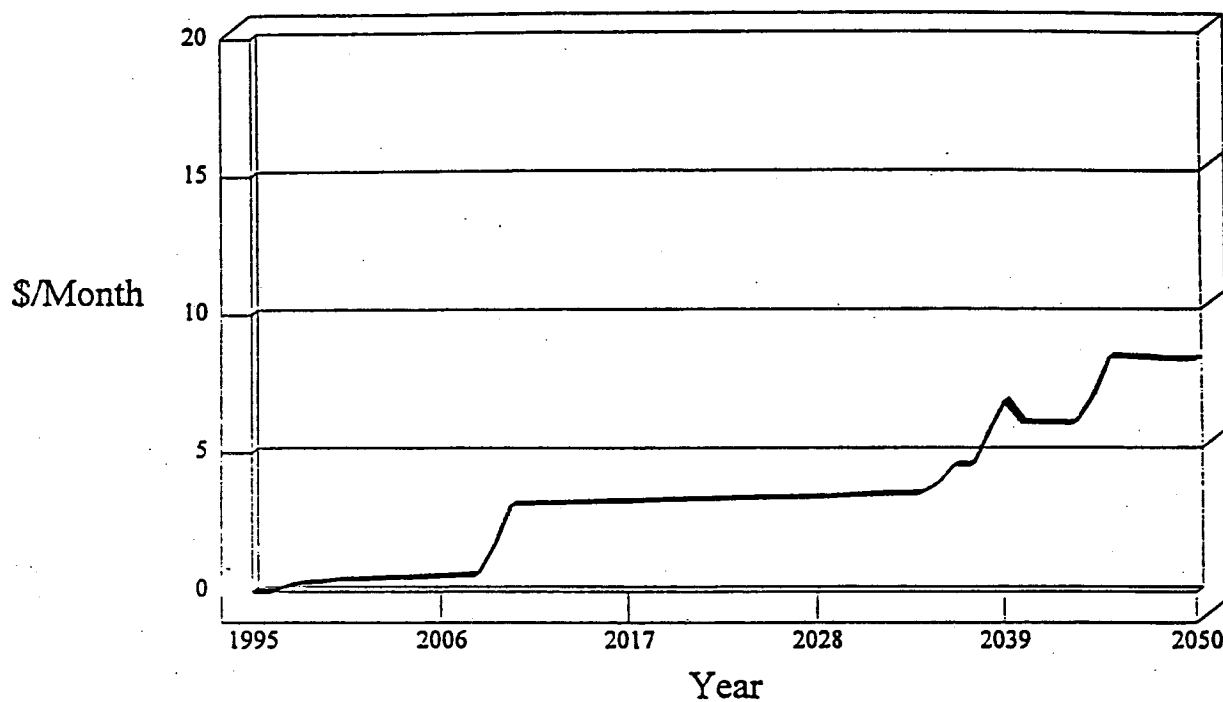

Notes:

Based on 8,000 gallon monthly consumption.
Impacts expressed in nominal (inflated) dollars.

Implications

These results indicate that even if the region were to pursue the highest possible level of reliability and demands turn out to be high—major resource additions would not be required until well into the 2020s. This conclusion is critically dependent on the region developing committed sources in a timely manner and local transmission interconnections.³⁴ As long as that occurs, the region has considerable time before new resources must be developed.

This does *not* mean the region can afford to defer a decision on which resource strategy will be pursued. As discussed in Chapter XII, the region faces many challenges in the short-term that will require action to ensure the needs of individual providers will be met. Policymakers' adoption of policy objectives and a long-term resource strategy will set the context within which these shorter-term decisions must be made. It will also guide discussions on a variety of issues between regional providers and state and local agencies. It will provide important direction to water providers, guiding near-term actions such as regional conservation program implementation and additions to the region's transmission system (both local and regional increments).

The latter point deserves some additional discussion. As pointed out in Chapter VIII, it is critical to upgrade the existing transmission system infrastructure in order to meet the near-term needs of individual providers. While such upgrades are necessary regardless of source options ultimately developed, the sizing and configuration of those upgrades will correspond with existing or future sources. Thus, in order to meet near-term local needs in a manner that will be consistent with the sources ultimately developed, a long-term resource strategy is essential.

CONCLUSIONS AND RECOMMENDATIONS

For more than five years, the water provider participants in the Portland metropolitan region have been meeting to address how to meet the region's future water supply needs. The RWSP project started in May of 1993. Since then, thousands of hours have been spent on the project. Several thousand pages of reports have been generated to summarize the work completed to date.

The water providers have been and remain committed to examining the range of

³⁴ Without conservation and committed sources, the region will require new resources beginning around the year 2004, assuming high demands.

The water providers have been and remain committed to examining the range of potential options for meeting future needs, and to evaluating them in a fair and open process. The integration of information generated with the concerns and values expressed by regional stakeholders, along with the desire to retain a regional perspective, has provided some very interesting and useful insights into the possible ways to meet water supply needs.

Some of the things learned in the planning process include:

- A significant amount of water is available to the region.
- Supply facilities will be added to the existing supply base in the near-term. These “committed resources” include expansion of Barney Reservoir and the treatment facilities on the Tualatin River, additional intake and treatment capacity on the Clackamas River, and the return of Portland's Columbia South Shore Wellfield to full capacity.
- Given existing and committed resources, the region will not need major new supply increments until close to the year 2020, unless water demands increase faster than even high projections, or unless committed resource additions do not materialize. In this case, the schedule for bringing new resources on line would need to be accelerated. While the region must develop the “committed resources,” it has some lead time to revisit projected longer-term demand forecasts and study in more detail or pilot test future resource options.
- Conservation program opportunities and water reuse offer significant water savings to the region. Implementation of these measures will delay and reduce the need to bring new or expanded supplies on-line.
- The region is fortunate to have so many viable supply options.
- Regional growth patterns are very difficult to predict. The region needs to design a flexible plan that allows for reassessment of growth trends and the corresponding effects on water demand and supply conditions. Maintaining and updating the Regional Water Supply Plan is the best way to stay on top of changing circumstances.
- People care about their water supply. It is an important public service that touches their lives every day. Getting people involved is a genuine challenge because the answers to water supply questions are often very complex and easy

answers are elusive. People care a great deal about the environment, costs, water quality, system reliability, and efficient water uses. Tradeoffs occur between these values when considering different ways to meet our future needs.

As a result of the planning effort and analysis of alternative resource strategies presented in this chapter, the region's water providers felt it appropriate to share with citizens and decision makers a sense of how well the alternative resource strategies meet regional priorities and values embodied in the policy objectives identified for this project.

It must be re-emphasized that no one "right answer" exists that perfectly meets all of the public's values. This is why several strategies were designed, evaluated, and presented for public review in the form of the Preliminary Regional Water Supply Plan. Citizens were asked to consider near-term and long-term resource decisions as well as institutional strategies. Reaching a regional consensus depends on extensive discussions of the alternatives, public review and comment, and hearings on both the preliminary and final plans.

The Role of System Reliability

As discussed earlier in this chapter, maintaining appropriate level(s) of system reliability (or supply shortage management) is key to the success of the RWSP. The modeling results indicate that the region can maintain the highest level of supply reliability for the next 25-30 years without any major resource additions beyond those to which regional providers have already committed. However, while near-term system reliability is not a key decision variable, many of the near-term actions the region must pursue will be affected by resource choices to be made over the long-term. In addition, near-term actions other than development of the committed resources are necessary, particularly in the areas of transmission and conservation in order to achieve reliability objectives.

It is important for a regional dialogue to begin regarding appropriate future levels of water supply reliability. Yet, that decision does not have to be made before going forward with required near-term actions outlined in Chapter XII. The Regional Water Supply Plan will also be revisited and revised on a periodic basis. These plan updates will provide new and useful information that will, at the appropriate time, assist the region's decision makers in determining the level of future reliability to pursue in the long-term.

Evaluating and Deciding Among Long-Term Water Supply Strategies

Based on the evaluation of Strategies 1 through 5, the region's providers suggested a ranking based upon how well each strategy was believed to meet the entire range of policy objectives. Table XI-10 shows the ranking of the five strategies as recommended by the regional providers in the Preliminary RWSP. The providers recommended Strategy 5 for consideration during preliminary RWSP review because it seemed to best meet the broadest array of policy objectives identified through the planning process. The advantages of Strategy 5 include:

- *Costs are relatively low.* The strategy brings sources on-line that are close to areas where demands will occur, in increments sized to meet needs as they occur.
- *Environmental impacts are relatively low.* The Clackamas and Willamette both have relatively low impacts on the natural environment. ASR uses higher winter flows from sources, reducing the need to divert summer flows. Other impacts from development of these sources are relatively low, as evaluated in project analyses.

**Table XI-10
RANKING OF RESOURCE STRATEGIES**

Water Provider Ranking	Strategy Number	Resource Additions	Emphasized Policy Objectives				
			Natural Environment	Water Use Efficiency	Raw Water Quality	Costs	Catastrophic Events
1	5	Outdoor Conservation, ASR, Clackamas, Willamette	✓	✓		✓	✓
2	3	Outdoor Conservation, Clackamas, Columbia		✓	✓	✓	
3	4	Outdoor Conservation, ASR, Willamette, Columbia		✓			✓
4	2	Outdoor Conservation, Bull Run Dam 3		✓	✓		
5	1	Maximum Conservation, Willamette	✓	✓			

- *Efficient use of water is emphasized.* Targeting outdoor conservation programs is the most cost-effective way to reduce demand during the peak summer season, when demands are highest and supplies most constrained.
- *Source diversity and additional transmission provide system robustness and reliability.* Adding two new sources and additional transmission to the current mix of existing water sources and facilities reduces the region's vulnerability to catastrophic events.
- *Phasing provides the flexibility to deal with future uncertainty.* Addressing needs in small increments over time allows the region to reassess demand, explore alternatives such as reuse and direct source use for non-potable water needs, and adjust course if one or more of the new or expanded sources cannot be implemented for any reason.

The overall raw water quality rating for Strategy 5 is comparable to Strategies 1 and 4. It is not as good as Strategies 2 or 3. The RWSP's raw water quality analysis has revealed that the quality of all the surface supply options is high when compared to most other municipal sources nationwide. The conservative treatment approaches recommended for the river sources provide multiple-barrier protection against current and future contaminants and would yield good-tasting water. Moreover, the Willamette and ASR would both be used primarily as peaking sources. For the vast majority of any year, the region will continue to be served by the Bull Run, the Trask/Tualatin, the Clackamas, and existing local supplies (primarily groundwater). In addition, a likely injection source for ASR would be the Bull Run due to winter surplus and low operating costs.

Resource strategies 1 through 4 are also fully capable of meeting the region's water supply needs. They address some of the same policy objectives and, in many cases, do a better job at meeting particular objectives than Strategy 5. Nevertheless, none of the other alternatives seemed to meet so many objectives important to both citizens and water professionals responsible for providing effective water service to the region.

The other strategies emphasize certain policy objectives over others. Strategy 1 maximizes water use efficiency and minimizes environmental impacts, but does not perform as well in areas such as cost or quality of source water. Strategy 2 maximizes raw water quality, but has a high cost and high environmental impacts and is inflexible in the face of future uncertainties. Strategy 3 involves less cost than 1 and 2, reduces environmental impacts, and utilizes a new source with slightly better raw water quality.

Strategy 4 emphasizes reducing the region's vulnerability to catastrophic events by bringing three new sources of water on-line. However, this approach results in higher adverse impacts to the natural environment and relies on two sources with lower raw water quality than existing sources.

The recommendations presented in the preliminary plan as outlined in this chapter reflected feedback on policy tradeoffs and priorities gained throughout the project using a range of public involvement tools discussed in Chapter III. The providers recognized, however, that the regional discussion of the preliminary plan would likely reveal that citizens value strategies that emphasize particular objectives over others. Thus, these alternatives were presented for regional consideration.

In summary, the preliminary plan, along with the supporting technical reports, presented sufficient information for the public and decision makers to evaluate the sources under consideration for the region's long-term strategy. Chapter XII contains highlights of the preliminary RWSP review process and revised final recommendations for the near-term, long-term, and institutional strategies.

The region's water providers have been, and continue to be committed to an open and fair discussion about the merits of material presented in this plan. The public's response concerning the resource strategies presented and how these meet their needs is important. The providers now recommend a strategy in Chapter XII that they feel best reflects an appropriate set of tradeoffs among the broad array of policy objectives, as refined through a region-wide dialogue. This strategy is presented in the following chapter.

**XII. RECOMMENDED FINAL PLAN CONCEPT AND
IMPLEMENTATION ACTIONS**

XII. RECOMMENDED FINAL PLAN CONCEPT AND IMPLEMENTATION ACTIONS

INTRODUCTION

The previous chapter presented a record of how different resource strategies, which include conservation and source options, were analyzed in preparation of the Regional Water Supply Plan Preliminary Report (August 1995). These resource strategies were designed to meet different sets of policy objectives. The evaluation of the strategies illustrated the respective tradeoffs associated with meeting different types of priorities.

The preliminary plan contained recommended actions to bring near-term committed resources on-line, initiate conservation programs and source development to meet future water demands, maintain the viability of source options over the long-term, and establish institutional mechanisms for implementing the plan.

After a review period of twelve months in total, the project participants have revised the preliminary Regional Water Supply Plan and crafted the final report. Chapter XII highlights the preliminary plan public review process and presents the revised policy objectives and plan strategy. Also presented are specific actions to implement the plan including a proposal to form a regional water provider consortium to ensure that the plan is implemented effectively over time.

HIGHLIGHTS OF THE PRELIMINARY PLAN REVIEW PROCESS

In September 1995, the project participants released the preliminary draft of the Regional Water Supply Plan report. The participants circulated the draft plan and supporting information region-wide, seeking review and comments from citizens and stakeholders. The participants also offered multiple opportunities for interested parties to provide feedback on the plan.

The participants sponsored preparation of a video on the planning effort. The video was made available to citizens and interest groups. Project staff gave, on request, numerous presentations to citizens, civic and interest groups, agency staff, and decision makers.

The participants mailed and distributed more than 5,000 newsletters to interested parties region-wide. The newsletter described the plan, offered additional information on request, announced several upcoming public workshops, and solicited written feedback on the plan via a "clip-and-mail" section. Nearly 100 written responses were received.

The project participants held three public workshops on the preliminary Regional Water Supply Plan in late September. One workshop took place in each of the region's three counties. The workshops were advertised in regional and local newspapers and the project newsletter. About 49 people attended the workshops. Many of them provided comments on the plan. The comments were recorded by staff and project consultants, and distributed to participant decision makers for review prior to official public hearings on the plan.

Comments on the preliminary plan which were submitted during the public workshops and through the newsletter clip-and-mail are summarized in Appendix F of this report.

Citizens and stakeholders expressed support of the planning effort generally, but also expressed a number of questions and concerns. Key issues raised included:

- Water quality - Raw water quality was emphasized by many while some others were concerned primarily with water quality at the tap. Substantial concerns were raised regarding the quality and suitability of the Willamette and Columbia Rivers for future drinking water sources. Some citizens (primarily Portland residents) stated strong preferences for Bull Run water. Others were open to multiple options. Stakeholders continued to raise questions regarding the technical feasibility and potential water quality problems associated with aquifer storage and recovery (ASR). Some suggested that providers give additional consideration to the Little Sandy River as a potential, good quality source of water.
- Conservation - Citizens and stakeholders expressed strong support for aggressive conservation approaches, particularly outdoor and industrial conservation, and conservation pricing. Some noted that uniform conservation standards may not work region-wide, but emphasized the need for regional participation and equitable levels of effort among participating jurisdictions.
- Non-potable/alternative sources - Providers were asked to pay more attention to dual systems as potential options for meeting future water demand. A number of citizens supported reserving high raw quality water for drinking purposes and using lower raw quality water only for non-potable purposes.
- Regional growth issues - Some citizens expressed concern that expected population growth in the region would outstrip and degrade finite water resources. There was also fairly broad opposition to any plan that would require existing residents to bear economic or water quality related costs in order to meet the water demand of future population growth in the region.
- Cost - Citizens were interested in the costs of different resource options and how costs could be reduced. As mentioned above, there was a strong interest in ensuring that any costs would be allocated equitably.
- Environmental Protection - A number of citizens expressed concern about the impact of growth on finite water supply, water quality, aquatic ecosystems, recreation, etc. There was strong support for water resource and quality protection through watershed management. There is concern about the potential impacts of a third dam and reservoir in the Bull Run Watershed and how withdrawing more Clackamas River water will affect fisheries.
- Public Education and Public Involvement - There seemed to be general support for public education as a water and demand management tool. The providers were urged to make conservation education a high priority, and use education as "preventive medicine" to change people's water use behavior. There were several suggestions to put more effort into working on conservation education through schools and the media.

Before initiating official public hearings on the preliminary plan, each participating agency was given the same four questions to answer. The four questions were distributed to ensure that agency decision makers expressed their most strongly held policy values and their priorities specific to the plan. The questions are as follows:

1. The Preliminary Regional Water Supply Plan has identified policy values. Which of these key policy values are most important to you in meeting future water needs? Are there other policy values that are equally or more important to you? If so, what are they?
2. Do you agree with the recommended strategies contained in the Preliminary Regional Water Supply Plan? What strategies do you specifically not support and why?
3. What changes would you recommend for consideration in the final Regional Water Supply Plan?
4. Do you support the concept of forming a consortium of water providers through the adoption of an intergovernmental agreement when the final Regional Water Supply Plan is adopted? What types of functions do you think the region's water providers should carry out in a cooperative approach?

Each of the participating agencies held one or more public hearings before answering the four questions. All in all, more than 20 workshops and hearings were held between September 1995 and the start of the new year. Some held additional public workshops as well. The hearings process began in October. In some parts of the region the plan did not appear to be particularly controversial. However, numerous citizens attending hearings before the Portland City Council and the Metro Council raised a host of issues and concerns.

Subsequent to these workshops and hearings, the majority of the participant agency decision-making bodies submitted written responses to the four common questions. The questions were used to help facilitate and make comparable the agency responses. The responses reflected in large part the concerns that decision-makers had heard from the public during the hearings process.

Project planning staff compiled and provided a written summary of the agency responses. The summary highlights key policy issues, commonly held values and priorities, and areas of major concern or disagreement among the project participants. The summary of participant agency responses is provided as Appendix F of this document.

Issues raised in the agency responses were grouped into four main categories. The Steering and Participants Committees generated a list of plan revision concepts to address the agency concerns and conflicts. The issues and revisions concepts are summarized below.

- System Reliability - The participants have expressed diverse opinions regarding which level(s) of future system reliability the plan should establish. For purposes of this planning effort, the term "system reliability" has been defined in terms of the frequency and magnitude of supply shortages that could occur during future summers and early autumns. The IRP model (discussed in Chapter X) estimated that existing and committed resources system capacities should be able to meet projected future demands on all but the hottest days during future summers.

Many of the participants have expressed strong support for establishing a 100 percent system reliability (or summer water availability) level in the plan. Others feel that the economic and environmental costs are too high to size and time water system development to meet 100 percent of the demand on the hottest days. Some recommend that peak water use be curtailed occasionally during the hottest days to reduce costs and impacts.

After much discussion, the participants agreed that the Regional Water Supply Plan should give future decision makers flexibility in determining the appropriate level of reliability to pursue. They agreed that the plan should not at this time establish specific standards for future supply related reliability levels. However, the revised plan does direct the providers to initiate a region-wide discussion of system reliability issues and tradeoffs in the near-term.

- Water Source Options - The majority of participants expressed support for resource strategy 5 (then called Strategy 1.5) and the accompanying implementation actions recommended in the preliminary plan. A few did not and recommended a number of changes.

There was, and continues to be unanimous agreement among all participants that each of the water supply options should remain viable for consideration as potential future water sources. However, some participants stated that the preliminary report was not specific enough about how near-term local water demands would be met. Others felt that the report was too specific in establishing which new water sources will meet water demand projected to occur 40 or more years in the future.

A number of citizens and stakeholders gave testimony expressing substantial concern and opposition to the proposed inclusion of the Willamette River in the package of future regional water sources. These concerns were raised primarily in hearings before the Portland City Council and the Metro Council. In response, Metro encouraged additional study and improvement of water quality prior to using the Willamette as a potable source in the region. Portland expressed its intention to continue relying on Bull Run as its sole source of water (with the exception of seasonal and emergency supplements as needed from the Columbia South Shore Wellfield and other sources identified in the City's Seasonal Water Contingency Plan). Several other participants also expressed some concern about selecting the Willamette for future potable use at this time.

In addition, several participating agencies requested that the revised plan include additional emphasis on environmental stewardship, including protection of water source water quality and fisheries. Several agency responses contained questions about the technical viability and water quality uncertainties associated with aquifer storage and recovery.

The participants agreed that the plan must highlight the need to keep each of the sources evaluated in the plan available and viable for potential future use. However, it was felt that the revised plan should provide more specific direction for near-term implementation and less specificity in terms of long-term actions and decisions. For example, the revised plan must recognize that some parts of the region have imminent water demands which need to be met through conservation, new transmission, and/or additional supply from one or more of the sources under consideration (including the Willamette). The role of transmission should be clarified. The plan would emphasize that key uncertainties (e.g., population growth, reliability choices, regulatory changes, etc.) will influence actual plan implementation decisions in the future.

It was agreed that the revised plan concept would include near-term committed resources, new conservation programs, exploration and implementation of viable non-potable options, exploration and implementation (after 2024) of viable ASR projects, and up to 50 mgd of additional development (after 2030) on the Clackamas River (over and above the 22.5 mgd planned for development by 2005). The plan strategy acknowledges that additional demands (e.g., sometime after 2035) may require more

1. The Preliminary Regional Water Supply Plan has identified policy values. Which of these key policy values are most important to you in meeting future water needs? Are there other policy values that are equally or more important to you? If so, what are they?
2. Do you agree with the recommended strategies contained in the Preliminary Regional Water Supply Plan? What strategies do you specifically not support and why?
3. What changes would you recommend for consideration in the final Regional Water Supply Plan?
4. Do you support the concept of forming a consortium of water providers through the adoption of an intergovernmental agreement when the final Regional Water Supply Plan is adopted? What types of functions do you think the region's water providers should carry out in a cooperative approach?

Each of the participating agencies held one or more public hearings before answering the four questions. All in all, more than 20 workshops and hearings were held between September 1995 and the start of the new year. Some held additional public workshops as well. The hearings process began in October. In some parts of the region the plan did not appear to be particularly controversial. However, numerous citizens attending hearings before the Portland City Council and the Metro Council raised a host of issues and concerns.

Subsequent to these workshops and hearings, the majority of the participant agency decision-making bodies submitted written responses to the four common questions. The questions were used to help facilitate and make comparable the agency responses. The responses reflected in large part the concerns that decision-makers had heard from the public during the hearings process.

Project planning staff compiled and provided a written summary of the agency responses. The summary highlights key policy issues, commonly held values and priorities, and areas of major concern or disagreement among the project participants. The summary of participant agency responses is provided as Appendix F of this document.

Issues raised in the agency responses were grouped into four main categories. The Steering and Participants Committees generated a list of plan revision concepts to address the agency concerns and conflicts. The issues and revisions concepts are summarized below.

- System Reliability - The participants have expressed diverse opinions regarding which level(s) of future system reliability the plan should establish. For purposes of this planning effort, the term "system reliability" has been defined in terms of the frequency and magnitude of supply shortages that could occur during future summers and early autumns. The IRP model (discussed in Chapter X) estimated that existing and committed resources system capacities should be able to meet projected future demands on all but the hottest days during future summers.

Many of the participants have expressed strong support for establishing a 100 percent system reliability (or summer water availability) level in the plan. Others feel that the economic and environmental costs are too high to size and time water system development to meet 100 percent of the demand on the hottest days. Some recommend that peak water use be curtailed occasionally during the hottest days to reduce costs and impacts.

After much discussion, the participants agreed that the Regional Water Supply Plan should give future decision makers flexibility in determining the appropriate level of reliability to pursue. They agreed that the plan should not at this time establish specific standards for future supply related reliability levels. However, the revised plan does direct the providers to initiate a region-wide discussion of system reliability issues and tradeoffs in the near-term.

- Water Source Options - The majority of participants expressed support for resource strategy 5 (then called Strategy 1.5) and the accompanying implementation actions recommended in the preliminary plan. A few did not and recommended a number of changes.

There was, and continues to be unanimous agreement among all participants that each of the water supply options should remain viable for consideration as potential future water sources. However, some participants stated that the preliminary report was not specific enough about how near-term local water demands would be met. Others felt that the report was too specific in establishing which new water sources will meet water demand projected to occur 40 or more years in the future.

A number of citizens and stakeholders gave testimony expressing substantial concern and opposition to the proposed inclusion of the Willamette River in the package of future regional water sources. These concerns were raised primarily in hearings before the Portland City Council and the Metro Council. In response, Metro encouraged additional study and improvement of water quality prior to using the Willamette as a potable source in the region. Portland expressed its intention to continue relying on Bull Run as its sole source of water (with the exception of seasonal and emergency supplements as needed from the Columbia South Shore Wellfield and other sources identified in the City's Seasonal Water Contingency Plan). Several other participants also expressed some concern about selecting the Willamette for future potable use at this time.

In addition, several participating agencies requested that the revised plan include additional emphasis on environmental stewardship, including protection of water source water quality and fisheries. Several agency responses contained questions about the technical viability and water quality uncertainties associated with aquifer storage and recovery.

The participants agreed that the plan must highlight the need to keep each of the sources evaluated in the plan available and viable for potential future use. However, it was felt that the revised plan should provide more specific direction for near-term implementation and less specificity in terms of long-term actions and decisions. For example, the revised plan must recognize that some parts of the region have imminent water demands which need to be met through conservation, new transmission, and/or additional supply from one or more of the sources under consideration (including the Willamette). The role of transmission should be clarified. The plan would emphasize that key uncertainties (e.g., population growth, reliability choices, regulatory changes, etc.) will influence actual plan implementation decisions in the future.

It was agreed that the revised plan concept would include near-term committed resources, new conservation programs, exploration and implementation of viable non-potable options, exploration and implementation (after 2024) of viable ASR projects, and up to 50 mgd of additional development (after 2030) on the Clackamas River (over and above the 22.5 mgd planned for development by 2005). The plan strategy acknowledges that additional demands (e.g., sometime after 2035) may require more

supply resources, but no specific source option is earmarked to meet this demand. Future decisions to specify a source would be made pending further study and analysis.

The participants agreed that the plan policy objectives should more clearly highlight the value of source protection and environmental stewardship. They also decided that plan revisions should assign the water providers a participatory role in efforts to maintain source viability, protect and enhance source quality, and prevent source pollution.

- Conservation and Non-potable Source Options - Many participant agency responses included strong support for conservation as proposed in the preliminary plan. No agencies asked to reduce the emphasis on conservation. Portland and Metro requested that the revised plan provide more focus on conservation education, cost effective non-residential and indoor conservation (in addition to the outdoor conservation programs proposed in the preliminary report), and non-potable source exploration and implementation to delay the need for new supplies. Portland suggested that the plan present conservation targets to help participating agencies monitor plan implementation effectiveness over time. Metro expressed interest in having a role in implementing conservation in the region.

The participants agreed that conservation education is a necessary prerequisite to achieving success in implementing more aggressive conservation programs. The revised plan concept includes conservation education explicitly, along with the more aggressive outdoor conservation programs contained in the preliminary report. It also includes programmatic conservation water savings targets to help monitor program effectiveness.

The participants agreed that the plan should direct the regional water provider consortium and individual providers to continue exploring opportunities for conservation in the industrial, commercial, and institutional sector. The revised plan encourages providers to explore and pursue cost-effective non-residential and indoor programs as appropriate based on customer base characteristics and other relevant factors. Metro's role in the conservation effort would be explored as part of the plan implementation process.

The revised plan also includes clearer direction to the providers regarding the exploration of non-potable source options to begin in the near-term (e.g., before the next plan revision).

- Regional Water Provider Consortium - During public review of the preliminary plan, there was considerable input regarding the need to ensure that the plan was not only completed but implemented in a timely and effective manner. There was general support for the formation of a regional water provider organization as suggested in the preliminary plan.

Mirroring this public input, the participating agency responses expressed virtually unanimous support for the formation of a regional water provider consortium to implement the plan. In general, the providers support the creation of a cooperative organization which individual agencies would be able to join voluntarily, and which recognizes the individual missions and responsibilities of each member. A number of providers stated their opposition to creating "another layer of government."

Several agencies submitted suggestions regarding the potential role for the consortium. The participants agreed that the revised plan would make clear that the consortium would be established voluntarily, by inter-governmental agreement (IGA). The plan would also lay out a general mission statement and objectives to clarify the purpose for a regional water provider consortium. They also agreed to expand and refine the list of potential consortium functions contained in the plan.

In addition to these issues, some participating agencies requested that the final plan clarify the importance of cost-equity (e.g., those who benefit should pay) and land use in facilitating effective plan implementation. The revised plan includes new or refined policy objectives, implementation actions, and consortium functions to address these issues.

The conceptual revisions discussed above provided the basis for the subsequent written revision of plan policy objectives, plan strategy concept, and implementation actions. In late March 1996, the participants released a packet of proposed revisions to the preliminary plan. The revisions were circulated for public review from April through July. Stakeholder and public workshops were held to solicit comments on the revisions. The participants requested feedback from their respective decision-making bodies to ensure that the revisions captured and addressed expressed concerns.

Public, stakeholder, and participant feedback on the plan revisions was positive for the most part, indicating that major concerns expressed during the preliminary plan review phase had been recognized and adequately addressed. Most of the comments received were applicable to the plan implementation phase rather than at changing the plan itself. Citizens and stakeholders did, however, request a few additional plan changes. Project participants also confirmed their general comfort with the plan revisions while requesting several minor additional revisions be incorporated in the final plan. Workshop summaries and written correspondence on the revisions are attached as Appendix G *Comments on the March 1996 Proposed Revisions to the Regional Water Supply Plan Preliminary Report*.

The following few additional plan revisions have been made as a result of the review and comments on the proposed revisions to the preliminary plan:

- A *Purpose* section has been added to plan report at the outset of Chapter I *Introduction*.
- Implementation actions have been modified to emphasize that wellhead protection for ASR needs to start early and that the participants need to address potential ASR interference issues (i.e., with aggregate mine pits). Plan text has also been augmented to emphasize the need for more data regarding the opportunities and potential impacts of ASR.
- Plan text and implementation actions have been modified to further acknowledge public and agency concerns about Clackamas River streamflows and fisheries. The plan clarifies the water providers' commitment to study Clackamas River fishery issues as needed to learn how future water supply increments should be developed to maintain and enhance important fish resources.
- Implementation actions and plan text have been amended to encourage participation in source protection efforts, emphasize the need to assess the full costs of source protection, and note that water quality monitoring should be conducted under varying flow conditions.

- Plan graphics have been amended to show explicitly that: 1) pilot studies have been done and may be expanded or augmented prior to development of the non-specified "source increment" proposed to come on-line sometime after 2035; and, 2) public health information would be considered during plan revisions and implementation decision points.
- The lists of plan implementation actions and potential Regional Water Providers' activities were augmented to encourage coordination and decision-making in consideration of inter-relationships between land use, growth management, community livability and water resource sustainability.
- Plan text was amended to make clear that the policy objectives are not displayed or ranked in any priority order.
- Policy objectives were modified to acknowledge that: 1) conservation has a role in relation to environmental stewardship; 2) consideration of conservation should include both current and emerging opportunities; and, 3) water shortages can be managed through a variety of methods including supply- and demand-side management, and watershed protection.

The remainder of the chapter sets forth the final plan policy objectives, resource strategies and implementation actions in accordance with interim and final revisions described above.

POLICY OBJECTIVES

The policy objectives shown in Table XII-1 are meant to capture the full range of issues and concerns facing the region as it attempts to meet future water demand. They are used both as a basis for designing and evaluating resource alternatives, and as a framework to help guide future plan implementation decisions and actions. As mentioned above, several policy objectives have been amended or added to address key issues raised by the public and participating agencies as described above. The revised objectives form the basis for the proposed final strategies presented in this chapter.

One or more evaluation criteria and/or implementation actions have been crafted to correspond with, and measure how well each policy objective is being met. For a complete presentation and explanation of the role of the policy objectives, evaluation criteria, and corresponding implementation actions, refer to Chapter IV of this report.

Like the resource strategies presented in Chapter XI, the final resource strategy and implementation actions reflect a weighing and balancing of the policy objectives to meet multiple goals and priorities shared by citizens, stakeholders, and participating agencies during public review of the preliminary Regional Water Supply Plan. The policy objectives presented in tables and text are not weighted or presented in any particular priority order.

**Table XII-1
Regional Water Supply Plan -- Policy Objectives**

Efficient Use of Water

- Maximize the efficient use of water resources, taking into account current and emerging conservation opportunities, availability of supplies, practicality, and relative cost-effectiveness of the options.
- Make the best use of available supplies before developing new ones.

Water Supply Shortages

- Minimize the frequency, magnitude and duration of water shortages through a variety of methods including development and operation of efficient water supply systems, watershed protection, and water conservation.
- Ensure that the frequency, duration and magnitude of shortages can be managed.
- Ensure that decision makers retain the flexibility to choose appropriate risk of peak event shortages given applicable future conditions, constraints, and community values.

Impacts of Catastrophic Events

- Minimize the magnitude, frequency, and duration of water service interruptions due to natural or human-caused events, such as earthquakes, landslides, volcanic eruptions, floods spills, fires, sabotage, etc.

Operational Flexibility

- Maximize operational flexibility to best meet the needs of the region, including the ability to move water around the region and to rely on back-up sources as necessary.
- Ensure that the plan includes flexible strategies for meeting both sub-regional and regional water demands in the year 2000 and beyond.

Economic Cost and Cost Equity

- Minimize the economic impact of capital and operating costs of new water resources on customers.
- Ensure the ability to allocate capital and operating costs, e.g., rate impacts for new water supply, related infrastructure, and conservation water savings, among existing customers, future customers, and other customer groups, proportional to benefits derived by the respective customer group(s).
- Maximize cooperative partnerships to co-sponsor projects and programs that provide multiple benefits.

Table XII.1 continued
Regional Water Supply Plan -- Policy Objectives

Water Quality

- Meet or surpass all current federal and state water quality standards for finished (tap) water.
- Utilize sources with the highest raw water quality.
- Maximize the ability to protect and enhance water quality in the future, including support and participation in watershed protection and pollution prevention based approaches.
- Maximize the ability to deal with aesthetic factors, such as taste, color, hardness and odor.

Environmental Stewardship

- Minimize (i.e., avoid, reduce, and/or mitigate) the impact of water resource development on the natural and human environments.
- Foster protection of environmental values through water source protection and enhancement efforts, and conservation.

Growth and Land Use Planning

- Be consistent with Metro's regional growth management strategy and local land use plans.
- Facilitate and promote effective Regional Water Supply Plan implementation through local and regional land use planning and growth management programs.

Flexibility to Deal with Future Uncertainty

- Maximize the ability to anticipate and respond to unforeseen future events and changes in forecasted trends.

Ease of Implementation

- Maximize the ability to address existing and future local, state, and federal legislative and regulatory requirements in a timely manner.

These policy priorities are described further in conjunction with the recommended strategies presented in the following section.

RECOMMENDED WATER RESOURCE STRATEGY AND IMPLEMENTATION ACTIONS

The final recommended water resource strategy ("recommended strategy") is depicted conceptually in Figures XII-1 and XII-2. Notably, these graphics illustrate the dynamic and flexible nature of the plan. Resource increments are shown in Figure XII-2 to come on-line during an anticipated span of years rather than a set point in time. Decisions to develop new resource increments will depend on multiple factors, as listed in Figure XII-1, which can not be predicted with certainty at this time.

Figure XII-1
Generic Resource Strategy

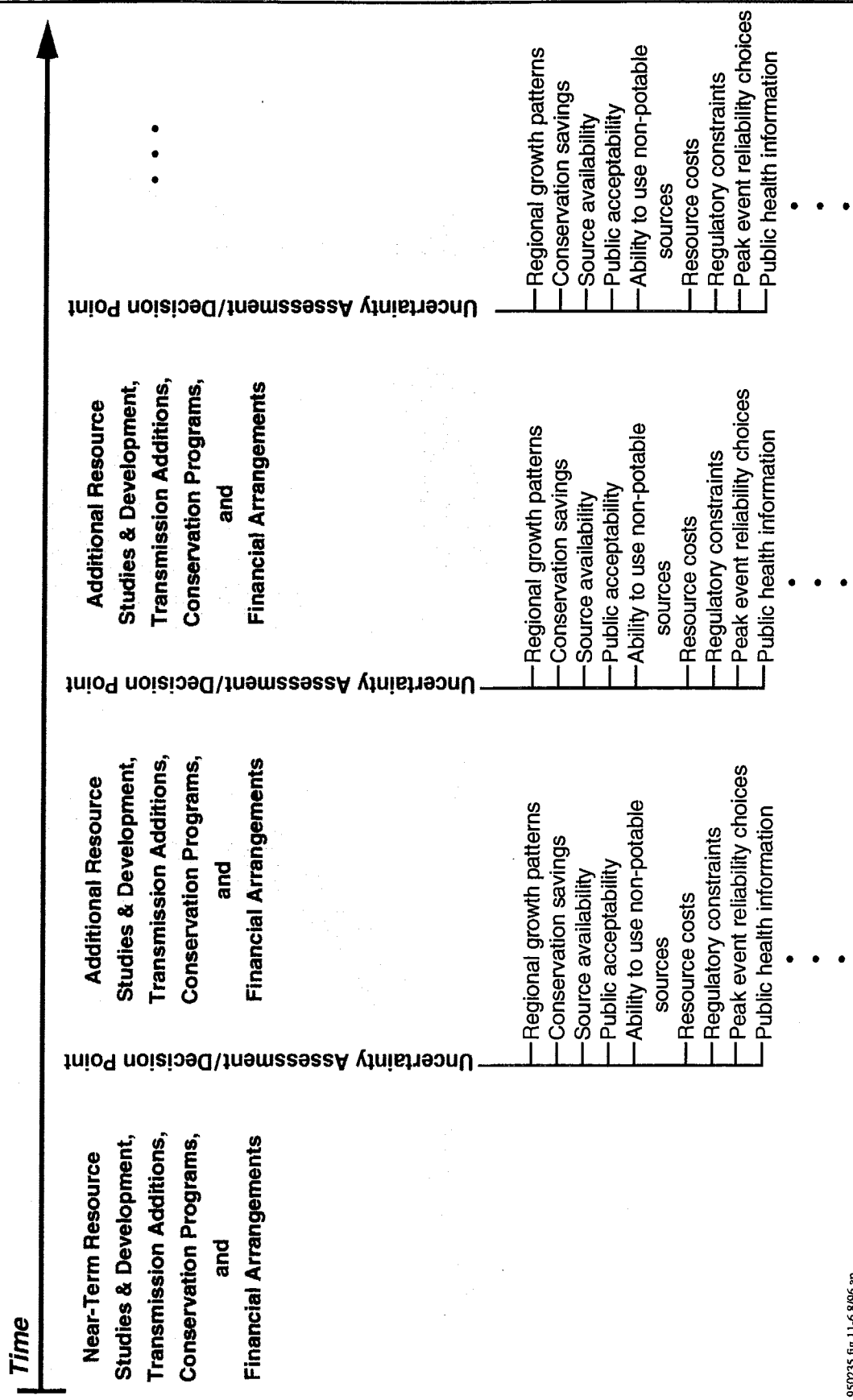
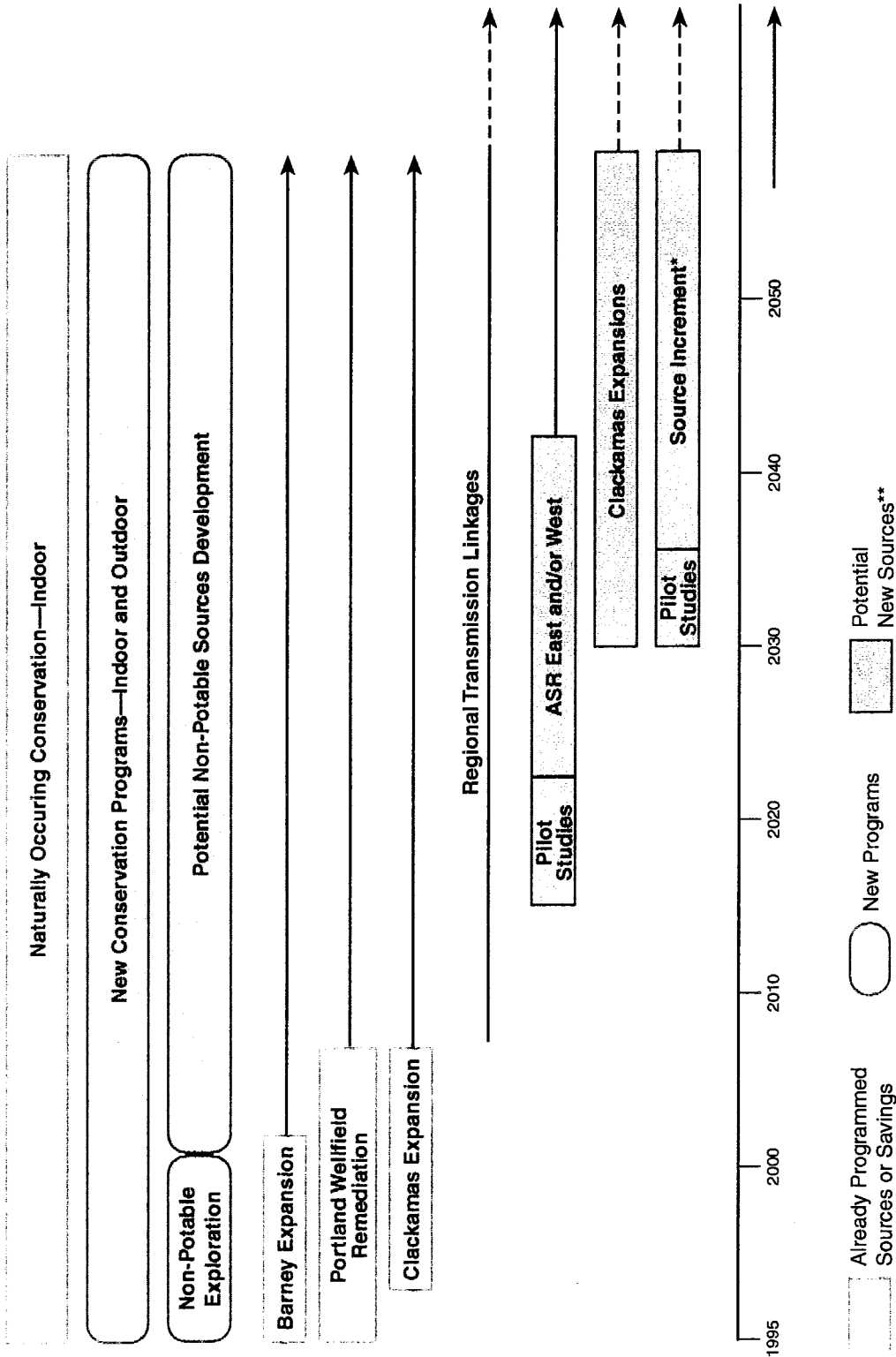

Figure XII-2
**Recommended Resource Strategy—
 Regional Water Supply Plan**



*Last Source Increment is unidentified, but could be Bull Run, Columbia, or Willamette

--> Option may not be needed until after 2050

**The need and timing for the Potential New Sources will depend on factors such as growth of demand, the need to meet all hottest peak events, transmission, small source development, and the actual savings due to conservation programs and development of non-potable sources. The time bands represent the possible years within which these sources might be needed and developed.

Key uncertainty factors include population and economic growth trends, water quality and regulatory trends, the availability of existing sources, and the effectiveness of bringing programmed sources, naturally occurring conservation, new conservation and non-potable programs on-line. The timing of bringing new resource increments on-line will be affected by the outcome of these types of uncertainties as well as choices the level of water supply reliability chosen by the region (or sub-regions). The implications of two key uncertainties, those associated with future water demand and water supply shortage reliability choices, is illustrated in Figure XII-3. The Regional Water Supply Plan will need to be kept current and revised as necessary to reflect changing conditions and outcomes over time.

As mentioned in the previous section, the final resource strategy has been designed to meet multiple policy objectives. The policy objectives reflect key priority issues expressed by citizens and stakeholders throughout the planning effort and during review of the preliminary plan.

The key elements of the strategy are grouped for illustrative purposes into *already programmed sources or savings*, *new programs*, and *potential new sources*. These key elements, along with accompanying implementation actions, are described below. Information produced as the host of implementation actions are carried out will need to be incorporated into the Regional Water Supply Plan updates in a meaningful and timely manner.

ALREADY PROGRAMMED SOURCES AND SAVINGS

Already programmed sources or savings include:

- naturally occurring and price induced conservation;
- expansion of the Barney Reservoir
- phased remediation of the Columbia South Shore Wellfield (by 2005); and
- expansion of Clackamas River water supply facilities (22.5 mgd by 2005).

Figure XII-3
Recommended Resource Strategy

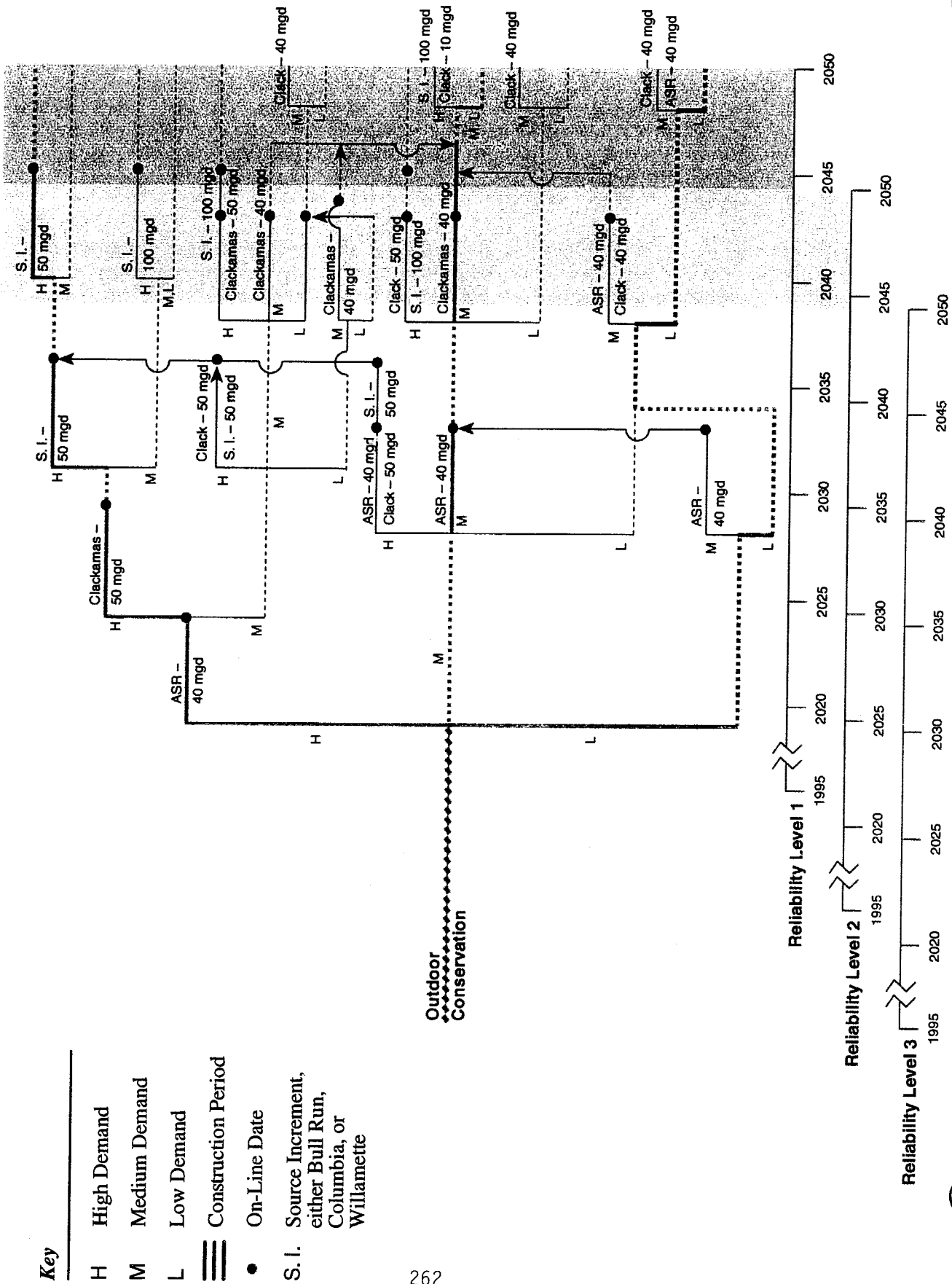

Naturally Occurring and Price-Induced Conservation

Naturally occurring conservation is that reduction in water demand which is expected to occur over time due to changes that affect water service technologies including building codes, appliance standards, and innovations in the marketplace. Naturally occurring conservation is assumed to occur without any additional program intervention on a water providers' part. For purposes of this project, naturally occurring conservation was factored into the regional demand forecasts to reflect the impact of new efficiency standards which are in effect for toilets, shower heads, and faucets, along with some assumed increase in market shares for high efficiency clothes washers and dishwashers. An additional reduction in demand was assumed to occur in conjunction with increases in real price over time. These incremental demand reductions were factored into the demand forecasts as well. The demand reductions associated with naturally occurring conservation and price net effects are substantial. By the year 2050, average peak season savings is estimated to reach 65.2 mgd. (Refer to Chapter V for additional detail.)

Expansion of Barney Reservoir

During the preparation of the Regional Water Supply Plan, steps have been taken to obtain the permits, funding, and design work needed to expand the existing 4,000 acre-foot Barney Reservoir on the Trask River. This expansion would increase available storage supply for the Joint Water Commission (serving Hillsboro, Beaverton, and Forest Grove) and the Tualatin Valley Water District by 16,000 acre-feet. Construction of the project began in 1995, and is scheduled for completion by 1998. It is also assumed that the Joint Water Commission Treatment Plant (on the Tualatin River) plant improvements to accommodate the additional water from Barney Reservoir will be complete by 1997.

Maintenance, Upgrades, and Remediation of the Columbia South Shore Wellfield

The City of Portland began construction of the Columbia South Shore Wellfield in 1980. The 22 well, 90-mgd capacity facility was completed in 1984. It was designed to serve as an emergency backup system and as a seasonal supply supplement to the Bull Run surface water system. In 1986, groundwater contamination was discovered. Use of the wellfield has been restricted to prevent migration of the contamination plumes. The City of Portland has committed significant resources toward restoring the wellfield to its full productive capacity. For purposes of this project it is assumed that by 2005 the wellfield will continue to serve as a backup source and will be available to provide at least 72 mgd to augment summer supplies for at least 90 days. Achieving these objectives will require the continuing efforts of Portland and its wholesale customers in conducting wellfield treatment evaluation, potential upgrades and maintenance. The City and the region will be relying on the cooperation of responsible parties and regulatory agencies to ensure that remediation efforts are successfully completed.

Clackamas Expansion(s)

For purposes of this project, it is assumed that the Clackamas area water providers will develop 22.5 mgd of additional supply capacity on the Clackamas River by 2005. A sub-regional group of providers is currently sponsoring a study to determine the appropriate location(s) for these near-term expansions. The study will also address potential long-term Clackamas expansions discussed below.

NEW PROGRAMS

New Programs include the initiation and implementation of a region-wide outdoor conservation effort and exploration/implementation of non-potable source options. These elements are outlined in more detail below.

Conservation

Conservation plays a key role in the proposed final resource strategy. Effectively implemented, water savings from both naturally occurring and outdoor conservation will, by the year 2050, provide about 126 mgd on a peak season basis. This projected savings provides substantially more "supply capacity" than any other single resource option identified in the final resource strategy.

Placing a strong emphasis on conservation helps to meet several key policy objectives. As described in Chapter XI, focusing on outdoor conservation can provide substantial water savings at a relatively low to moderate cost. Focusing conservation efforts on outdoor water uses makes efficient use of existing water resources. It will also provide environmental benefits by reducing water demand during periods of low streamflow. By targeting peak demand, the water providers can most effectively delay the need for new supply capacity which has both cost and environmental benefits.

The revised recommended strategy includes these conservation program concepts:

- Conservation education (focused on outdoor uses)
- Outdoor water audits (residential, industrial, commercial, institutional)
- Incentives to install water efficient irrigation and landscapes
- Landscape and irrigation ordinances for new developments
- Conservation pricing structures

The program concepts apply to all customer classes. The projected water savings associated with these outdoor conservation concepts is substantial. (For additional detail, refer to the *Conservation Program Descriptions* final report, Barakat & Chamberlin, Inc., May 17, 1995.) Table XII-2 shows regional peak season targets for water savings to be acquired through new programs. The targets reflect water savings which are projected to be achievable given the mid-range growth/demand forecast scenario. Peak season targets were chosen (vs. average annual or peak day targets) since the key conservation programs contained in the recommended strategy are designed to focus on demand throughout the peak summer season.

Table XII.2 - Conservation Savings Targets for New Programs*
(millions of gallons per day)

Forecast Yr.	2000	2010	2020	2030	2040	2050
Avg. Peak Season Savings (% of Avg. Peak Season Demand)	12.5 mgd (5.5%)	19.3 mgd (8.1%)	27.4 mgd (10.7%)	37.8 mgd (13.4%)	50.6 mgd (16.2%)	65.2 mgd (18.6%)

* Does not include savings estimates for naturally occurring conservation.

The final strategy involves initiating the region-wide outdoor conservation efforts immediately upon plan completion. Implementation actions include the following:

- Develop an operations level work plan for bringing new outdoor programs on-line on a regional, sub-regional, and/or individual provider basis. The work program will involve honing the programs to be implemented by individual providers, provider groups, and region-wide. It is anticipated that conservation programs may differ among participating providers.
- Establish budgetary resources and initiate implementation of conservation work programs.
- Establish mechanisms for addressing revenue impacts associated with conservation efforts. Incorporate into financial planning efforts.
- Develop a process for monitoring conservation program effectiveness over time. The programs will take some lead time to establish across the region, and to "ramp up" over time. It will be important to track whether conservation program investments are paying off in terms of water savings and whether conservation program targets are being met. The conservation targets presented above will be used in monitoring the effectiveness of conservation programs over time. The results of program effectiveness monitoring will be factored into plan revisions as needed.
- Continue to explore opportunities for viable indoor conservation program development. Investigate opportunities for substantial water savings by focusing on high-volume users (e.g., high-tech manufacturing industries). Implement viable programs as appropriate given customer mixes and values held in various provider service areas.

It is envisioned that the proposed regional water provider consortium will be responsible for coordinating and overseeing conservation program implementation and monitoring. The Columbia-Willamette Conservation Coalition provides an established cooperative network that can provide extensive conservation staff support to the consortium in carrying out this element of the RWSP.

Water Reuse, Recycling and Non-Potable Direct Source Options

As discussed in Chapter IX, there appears to be some substantial potential for water reuse, recycling, and direct use of non-potable sources for non-potable purposes in the

region. It is expected that implementing such "alternative sources" would meet several key policy objectives relating to water use efficiency, environmental stewardship, reliability, impacts from catastrophic events, and flexibility.

There are, however, a number of key considerations that need to be addressed in order to determine the viability and applicability of the different options in the region. Additional information on water quality, costs, markets, benefits, and impacts is needed to better define the role of these options in meeting future water demand.

The proposed final plan strategy involves prompt initiation of studies and pilot projects that will shed light on the potential usefulness of non-potable options. Under this strategy, substantial information will be developed by the year 2000 to help project participants hone the role of non-potable options and pursue implementation of viable options in a timely fashion.

It is important to continue serious exploration of these non-potable source options in the near-term since studying and piloting the options may take some time. It is also important to take advantage of viable opportunities as growth and new development are occurring and avoid the need to install costly retrofits after development is completed.

Implementation actions are as follows:

- Evaluate baseline non-potable uses and trends.
- Assess markets and costs for reclaimed wastewater region-wide.
- Analyze direct use/dual systems options.
- Examine potential for water reuse and recycling in the non-residential sector, with a focus on high-volume users (e.g., high-tech industries). (Also proposed under conservation section above).
- Explore potential for graywater sources and possible regulatory changes.
- Assess the potential to transfer water uses (e.g., points of diversion, places of use, and types of use) under existing water rights (e.g., irrigation to municipal, surface water to groundwater) to meet multiple purposes.
- Investigate public education needs.

No specific water savings are projected in conjunction with non-potable source options at this time. However, findings from these analyses (e.g., projected water savings, infrastructure requirements, etc.) will be incorporated during updates of the Regional Water Supply Plan. Such findings may indicate that the need to bring potential new sources on line can be delayed. It is envisioned that one or more water providers, in partnership with wastewater agencies or others, would implement viable projects as needed to meet demand and defer or delay new source development.

Regional Transmission Linkages

In the preparation of the resource strategies the need to add regional transmission linkages was evaluated for each set of strategies. The timing is linked to achieving different levels of system shortages during peak events. The need for new supplies was

preceded by first adding transmission capacity between and/or within nodes. New supplies are added only when necessary and are accompanied by the minimum necessary inter-nodal transmission capacity to move the new supply to appropriate demand node(s). In the final strategy the earliest inter-nodal (or regional) transmission addition is programmed for 2010. It is recommended to provide system redundancy for catastrophic protection and potentially the need to serve local areas of demand utilizing existing sources of supply. The actual timing of these regional transmission linkages will need to be evaluated as the RWSP is reassessed and revised over time.

Later needs for regional transmission facilities will be determined based on the timing established for new source increments. The selection and location of the last non-specific source increment, regardless of its timing, are important future decisions which will be necessary before implementing further regional transmission linkages. In the meantime, local transmission additions should be programmed with consideration of the potential future supply sources identified in the RWSP.

POTENTIAL NEW SOURCES

Potential New Sources shown as part of the final resource strategy include development of regional scale aquifer storage and recovery facilities, additional capacity on the Clackamas River, and supply capacity on one or more, as yet unspecified, sources including the Willamette River, Columbia River, or Bull Run Watershed. These potential new sources are characterized in Chapter VII and XI of this report. Their respective roles in the final strategy, along with near-term, long-term, and ongoing implementation actions are described below.

Aquifer Storage and Recovery (ASR) Option

Figure XII-2 indicates that the successful implementation of programmed sources and savings, plus water savings from new conservation programs could delay the need for new regional-scale sources until at least 2020. The proposed resource strategy recommends that ASR be implemented to provide up to 40 mgd of supply to meet demands forecasted to occur between about 2020 and 2040. (Implementation of viable non-potable source options could delay this need further).

As described in Chapter VII, ASR seems to be a promising option to help optimize the use of existing supplies and provide seasonal source augmentation on both the west and east sides of the region (Cooper-Bull Mountain and Powell Valley, respectively). Based on analysis to date, this technology would appear to meet several key policy objectives. The costs appear to be low relative to other alternative source options. Environmental impacts are also expected to be relatively low since this technology would help take demand pressure off rivers and streams during low flow periods. Water quality values can be factored into future decisions regarding which source(s) of water to store and recover using ASR.

Additional information will be generated to assess the potential costs and impacts (including effects on peak streamflows) of ASR through required permitting and pilot procedures. Additional study will also be necessary to confirm the hydrogeologic feasibility of ASR in the region as well as the effects on local hydrologic conditions, water quality, environmental values, and existing groundwater users near potential facility sites. Recently adopted Oregon Administrative Rules require pilot testing (which can last up to five years) before the Water Resources Department can process permits for permanent facilities. Several tests may be needed to find a viable facility site. Initiation

of pilot testing needs to begin well in advance of when the actual source increment is needed.

Implementation actions to confirm the viability of ASR, maintain ASR viability over time, and facilitate ASR testing and development (when it is needed) include the following:

- Conduct, leaving sufficient lead-time before ASR is needed, studies and/or pilot tests as needed to determine the hydrogeologic feasibility, reliability, costs, and potential effects on hydrologic conditions, environmental values, and existing groundwater users.
- Consider pursuing acquisition of right-of-way or land as needed to facilitate ASR development in the future.
- Begin wellhead protection and mitigation opportunities prior to the pilot test phase of ASR development.
- Begin coordination with local land use agencies and Metro to ensure that land use planning and growth management efforts are carried out in recognition of potential ASR development. Examples might include identifying and managing potentially conflicting land uses and/or actively protecting existing groundwater sources in areas where ASR may be considered.
- Work with land use agencies to assess and manage potential interactions between ASR projects and aggregate mine pits (Cooper-Bull Mountain).

Clackamas River Option

As shown in Figure XII.2, demand for the next potential water supply increment following the ASR increment described above is projected to occur as early as 2030. The final resource strategy shows that this demand increment would be met by up to 50 mgd of additional supply from the Clackamas River.

Development of additional supply from the Clackamas River is desirable in terms of meeting the plan policy objectives. Clackamas river water rates highly in terms of both raw and treated water quality. Developing an additional increment (at a consolidated site) was determined to be more economical than other resource alternatives with the exception of certain conservation programs and ASR. Additional reliable supply can be developed using existing water rights. While there is concern about the status of Clackamas River fisheries, experts expect that a new increment not to exceed 50 mgd should not have severe adverse environmental impacts. The health of fisheries and ecosystems will need to be monitored and values preserved as plan implementation proceeds.

Implementation actions to maintain and enhance the viability of the Clackamas source option include the following:

- Complete, by 1997, the Clackamas-water-provider sponsored study to determine how programmed near-term supply from the Clackamas River (22.5 mgd) should be developed and further evaluate longer-term source increment options.

- Determine the scope of further study (e.g., Instream Flow Incremental Methodology (IFIM)) needed to learn how near- and long-term increments should be developed in a manner that can sustain and potentially enhance aquatic and fishery resource values. Conduct further study in accordance with this determination.
- Seek protection of the source and associated watershed(s). Participate as appropriate in relevant administrative and legislative efforts (including watershed councils) to manage riparian areas and uplands, forest and agricultural practices, industrial discharges and stormwater. Participate in local, regional, state and federal studies pertaining to water quality or other relevant studies on the Clackamas River.
- Coordinate with land use planning and growth management efforts to maintain and enhance source viability.
- Continue water quality monitoring efforts at varying flow conditions.

Source Increment (Non-Specified)

Figure XII.2 shows that the last resource increment may be needed to meet additional demand sometime between 2035 and sometime after the end of the planning horizon. The final resource strategy specifies which source(s) would be expected to meet demands beyond those to be met by conservation and supply options identified above. Rather than specify particular sources, it is assumed that additional capacity would, if needed, be obtained from the Willamette River, the Columbia River, and/or additional storage in the Bull Run watershed. For detailed description and evaluation of these sources for their consistency with policy objectives and criteria, refer to Chapters VII and XI of this report.

Deferring the selection of specific source(s) which may be needed to meet very long-term demands will enable participating agencies to develop information to further address priority issues raised during public review of the preliminary plan. Key issues include conservation and non-potable options potential, water quality in the Willamette and Columbia Rivers, environmental impacts of new storage in the Bull Run, etc.

The final resource strategy includes implementation actions designed to confirm, maintain, and/or enhance viability so that any of the three choices would be available at such time it might be needed in the future. These actions focus on obtaining additional water quality and environmental information, coordinating with relevant regulatory activities, participating in source protection and enhancement efforts, and identifying water quality and environmental mitigation and enhancement opportunities.

Implementation actions specific to each source option are as follows:

Willamette River Option

- Conduct further pilot treatment testing and water quality monitoring and analysis.
- Consider new information generated by the Willamette River Water Quality Study coordinated by the Oregon Department of Environmental Quality.
- Participate financially and with in-kind services in the Willamette Reauthorization Study sponsored by the State of Oregon and the U.S. Army Corps of Engineers.

- Seek protection of the source and associated watershed(s). Participate as appropriate in relevant administrative and legislative efforts, including watershed councils established in the lower Willamette Basin, to manage riparian areas and uplands, forest and agricultural practices, industrial discharges and stormwater. Support the efforts of watershed health and restoration efforts basin-wide.
- Participate in reservation review and water rights adjudication processes for the Willamette Basin.
- Support and participate as appropriate in efforts to insure maximum prevention and clean-up of pollution in the Willamette River.
- Monitor the performance of any local source development which may occur to meet imminent needs in parts of the region.
- Coordinate with local and regional land use planning efforts to assist in maintaining source viability.
- Continue water quality monitoring efforts at varying flow conditions.

Columbia River Option

- Continue monitoring and analysis of water quality.
- Consider new materials generated by the Lower Columbia River Bi-State Water Quality Study and National Estuary Program.
- Coordinate with local and regional land use planning efforts to assist in maintaining source viability.
- Participate in activities concerning policy, rules, or legislation affecting the Lower Columbia River.
- Seek protection of the source and associated watershed(s). Support and participate as appropriate in efforts to insure maximum prevention and clean-up of pollution in the Columbia River. Participate in relevant administrative and legislative efforts (including watershed councils) to manage riparian areas and uplands, forest and agricultural practices, industrial discharges and stormwater.
- Continue water quality monitoring efforts at varying flow conditions.

Storage Options in the Bull Run Watershed

- Seek protection of the source and associated watershed(s). Participate as appropriate in relevant administrative and legislative efforts including implementing the Clinton Forest Plan (Option 9 of the Record of Decision) for the Mt. Hood National Forest to protect the option to develop more storage in the Bull Run Watershed.
- Participate in Sandy Basin watershed councils.
- Participate in fisheries studies being conducted for the Sandy Basin.
- Participate in the adjudication of Sandy Basin water rights.

- Advocate protection of the Bull Run source. Also advocate protection of the Little Sandy Basin as a potential long-term municipal water supply source in case alternative source options outlined in this plan were to become non-viable.
- Conduct additional reconnaissance studies of the Log Creek Dam 3 option to answer questions relevant to protecting the option over the long-term.
- Coordinate with land use planning and growth management efforts to ensure viability of transmission options.
- Continue to explore the potential for avoidance or mitigation of environmental impacts from additional storage in the Bull Run. Incorporate new information on potential flow augmentation opportunities into future options analysis.
- Continue water quality monitoring efforts at varying flow conditions.

Given the dynamic and iterative nature of the final resource strategy, it is not possible to generate specific cost estimates for the strategy as a whole, particularly since the last potential source increment is not identified at this time. Information on the present value costs of specific conservation programs and source options is contained in Chapter XI. In addition, new information obtained via early phase plan implementation actions (e.g., conservation program implementation, further study and pilot testing projects for potable and non-potable source options, transmission, and ASR, etc.), will help the providers to refine the costs of future actions over time.

MEETING IMMINENT WATER SUPPLY NEEDS IN SPECIFIC LOCALITIES

The Regional Water Supply Plan process has focused primarily on regionally significant demands and resource options. The process did not address in detail the fact that certain localities in the region are facing more imminent needs than others. Examples of those entities which are likely to need new resource capacity prior to 2000 include the cities of Wilsonville, Tigard, Sherwood, Canby, and possibly the Damascus Water District.

This plan recognizes that steps must be taken in the near-term to meet these demands. Addressing these needs is identified in the next section of this chapter as a high priority implementation item for the proposed regional water provider consortium. It is not known at this time which resource options will be selected to meet near-term local needs. Conservation would be expected to help manage demand in these areas. Non-potable options such as direct use of river or groundwater could also contribute. On the supply side, seemingly plausible source options (due to availability of existing systems, proximity to alternative sources, and water rights availability) include connection and contracted purchase of water from existing systems (e.g., Bull Run, Clackamas), ASR, or construction of first phase supply facilities on the Willamette River. These near-term needs should be met, to the extent possible, in a manner consistent with the policies and long-term strategies set forth in this plan.

All of these resource options will be considered for their potential to help meet near-term demands. The region's providers may obtain important information on the viability of conservation, transmission, and source options based on the results of anticipated near-term projects. New information gained in bringing new local resources on-line will be integrated into the Regional Water Supply Plan to help guide future decisions in the region (e.g., transmission needs and location).

FORMATION OF REGIONAL WATER PROVIDERS CONSORTIUM

The sections below will discuss some of the overall institutional issues that have been a part of the formation of the Regional Water Supply Plan. The first section presents a brief overview of the institutional issues affecting water delivery service in this region, the second section presents the regional consortium recommendation, and the last section discusses the roles of Metro and the region's water providers.

Institutional Issues Discussion

The RWSP's basic premise has been that the appropriate institutional structure to deliver the region's water service will be driven by the resource strategy chosen. Thus, it is premature to recommend specific institutional arrangements. Regional providers and their customers will discuss any necessary changes over the next several years through a regional or sub-regional dialogue. It is, however, useful to list and briefly describe the existing types of institutional possibilities.

The current institutional structure for water supply includes a mixture of cities and special districts. Although a few water sources dominate, a much greater variety and number of entities distribute water. This has been changing in the last few decades, and the number of individual providers has fallen due to mergers or through annexation by cities.

Some of these entities are associations, such as boards or utility commissions, primarily made up of smaller cities that jointly operate their systems (e.g., the South Fork Water Board and the Joint Water Commission).

The following are brief examples of potential future institutional frameworks that could meet the region's water supply needs:

- (1) **Current structure.** The current structure of cities, special districts, and joint management agencies could be maintained. Any changes in the entities would be based upon the circumstances of the specific entities involved. Entities could agree to continue to meet informally, as the Regional Providers Advisory Group did before the RWSP process began.
- (2) **Consolidation or mergers into larger water provider entities.** Reducing the number of individual provider entities could be explored to achieve planning or operational efficiencies. This is exemplified by the 1995 formation of Clackamas River Water and the 1991 merger of Metzger with the Wolf Creek Water District to form the new Tualatin Valley Water District. In addition, annexation by cities has resulted in absorbing service districts into existing city water departments, such as the assimilation of the Richland, Rose City, Parkrose and Hazelwood water districts into adjacent cities and a PUD.
- (3) **Special joint agencies or new entities:** These could be formed as ORS 190 agreements (such as the Joint Water Commission and the South Fork Water Board) where constituent entities remain. New entities under various state statutes (special districts, PUDs) could be formed, including the formation of total water management agencies that deal with overall water management. Currently, these joint services are provided by some all-purpose cities, but could be done as special districts as well.

- (4) **Formation of water authorities.** Sub-regional or regional water authorities can pool water rights, facilities, and staff. These can be formed under ORS 450. Such entities could be retailers, wholesalers or both.
- (5) **Metro as a regional water provider.** Metro could become a regional water supplier as a wholesale entity or a full-service supplier/distributor (ORS 268.342). This may need to be established by ballot. Recent discussions with Metro have indicated that there is no desire at this point to take on the role of actually operating or managing water supply or distribution systems.

In the Portland region, cooperation among the numerous and diverse water providers has been, and will continue to be instrumental in evaluating, planning, and implementing conservation and supply system enhancements as proposed in this plan to meet future demand. Since 1989, water providers serving nearly 95 percent of the region's population have coordinated their water supply planning efforts. Metro joined this effort in 1994.

This level of commitment and cooperation among numerous and diverse water providers is virtually unprecedented nationally. The agencies, working with a multi-disciplinary consultant team, have provided the technical expertise, management skills, and funding to carry out a complex and innovative integrated resources planning project to its completion. It is critical now that appropriate mechanisms are established to implement the plan effectively and efficiently.

Although specific institutional changes to water supply entities are not being proposed as a part of this plan a recommendation to continue and improve institutional coordination is proposed. As mentioned earlier in this chapter, the participating agencies are supportive of developing a regional water provider consortium to be formed by intergovernmental agreement to cooperatively address key water resources issues and ensure that the plan is carried out. Participation in the consortium would be voluntary and at the discretion of agency decision-making bodies. This consortium would operate under existing institutional structures and would not involve formation of any new governmental entity.

PURPOSE, MISSION, AND FUNCTIONS OF A REGIONAL WATER PROVIDERS CONSORTIUM

The main role of the consortium will be to coordinate and oversee implementation of the Regional Water Supply Plan. In responding to the question about the formation of a regional consortium the decision making bodies expressed support but also some concerns about the scale and scope of such an organization. The RWSP therefore contains the recommendation to form a consortium, but recognizes that as a first step such an organization will need to be flexible and able to grow over time into the proposed functions contained in this section of the plan. The consortium's mission will be contained in the intergovernmental agreement which will need to be adopted by each participating entity. The mission will recognize that participants retain authority over individual water supply systems and related policies. Any changes in institutional arrangements would be voluntary. The consortium will be based on the premises of:

- coordinating to ensure that participant activities are consistent with the policies, strategy concepts, and implementation actions in the Regional Water Supply Plan.

- encouraging and facilitating of partnerships to responsibly enhance water supply and reduce water demand.
- anticipating the need for timely implementation of planning decisions.
- ensuring that the costs of water supply projects and programs are allocated equitably to beneficiaries.

Anticipated consortium functions are as follows:

- 1) **Consortium Administration & Operation** - Establish by-laws or some other framework to govern consortium administration and operations. Establish membership criteria. Develop a consortium work program and associated budget. Obtain staff resources as necessary to carry out the work program.
- 2) **Plan Implementation & Monitoring** - Coordinate and oversee the implementation of the Regional Water Supply Plan. The consortium would be responsible for ensuring that:
 - key information, databases, and models (e.g., demand forecast, IRP model) are maintained and enhanced as needed;
 - near-term local needs are met in a manner consistent with and supportive of the Regional Water Supply Plan;
 - the status and effectiveness of bringing on-line of near-term and programmed water system enhancements, conservation programs, and the exploration and potential development of non-potable source options are monitored.
 - implementation actions outlined in this chapter are undertaken in a timely and effective manner to successfully meet future demand and protect and preserve resource options.
 - the Regional Water Supply Plan policy objectives, evaluation criteria, technical information, resource strategies, and implementation actions are reviewed and updated at least every five years and as needed to reflect new information and evolving priorities .
 - a strategy for overall monitoring of plan implementation is developed, including the setting and use of targets and milestones, and honing criteria to trigger plan revision.
 - partnerships are actively explored to facilitate the pilot work needed for developing regional aquifer storage and recovery strategies, for pilot tests of other surface water sources, and for non potable water system development.
- 3) **Intergovernmental Coordination** - Coordinate with local governments and Metro to identify and pursue opportunities within their jurisdictions to facilitate and promote plan implementation through land use plans, zoning codes, and growth management efforts (e.g., Region 2040 and the Regional Framework Plan). Promote decision-making in consideration of inter-relationships between land use, growth management, community livability and water resource sustainability.

- 4) **Source Protection Strategy** - Formulate a strategy for identifying priority source protection issues and activities which are underway or should be undertaken to protect and enhance the raw water quality and watershed health of existing or potential regional water sources. Initiate, support, and/or participate in such efforts as warranted to achieve source protection and enhancement objectives. Evaluate relative costs and benefits.
- 5) **Further Conservation Program Exploration** - Coordinate the exploration of subregional or regional opportunities for viable indoor conservation programs and facilitate the evaluation of these strategies by the Columbia-Willamette Conservation Coalition.
- 6) **Non-potable exploration and Development** - Facilitate the development of partnerships to conduct further studies and pilot programs to develop non-potable water systems in areas of the region where opportunities for these systems are most promising.
- 7) **Shortage Management Discussion** - Initiate, in the near-term, a region-wide discussion how choosing and pursuing different levels of peak hot weather event water supply reliability (relative to projected future demand) would affect key public concerns including the frequency and magnitude of shortages, cost and rates, and environmental values. Involve citizens and stakeholders discussing the tradeoffs.
- 8) **Catastrophic Event Coordination** - Explore the development of strategies for dealing with catastrophic events on a regional basis.
- 9) **Provider Representation & Coordination** - Represent the region's water providers as appropriate in various forums including but not limited to the activities of Metro, state and federal agencies, the Governor's office, and the Oregon State Legislature. Facilitate resolution of conflicts among water provider participants. Attempt to resolve apparent inconsistencies between individual providers' or groups of providers' activities, and the region's long-term interests.
- 10) **Public Education** - Coordinate the development and implementation of public education, information, and involvement in plan implementation and updates. Develop strategies to let citizens know about various activities, accomplishments and concerns.
- 11) **Finance Coordination** - Coordinate the evaluation of potential equitable arrangements to finance Regional Water Supply Plan implementation with particular emphasis on the following:
 - Develop guidelines and methodologies with which to determine how capital and operating costs for new water supplies should be allocated at regional and/or sub-regional levels.
 - Develop methodologies and mechanisms for identifying, anticipating, and addressing short- and long-term revenue impacts associated with implementation of conservation programs.
 - Identify and pursue partnerships with other agencies and the private sector to cost-share and co-participate in plan implementation strategies that provide multiple benefits.

- 12) **Institutional Forum** - Examine and make recommendations as appropriate on roles and responsibilities (e.g., Metro's role in conservation program implementation) and possible changes in institutional arrangements.

THE REGIONAL CONSORTIUM ROLE AND METRO'S ROLE

Metro is the area's regional government. It is the only elected regional government in the United States. Its powers are granted through Oregon Statutes (ORS 268), and it has a regionally adopted Charter. Metro's boundaries cover most, but not all, of the area covered by the RWSP.

Metro has the authority and responsibility to adopt and enforce the region's urban growth management strategy, including the adoption and revision of the Urban Growth Boundary (UGB). The UGB and growth management program applies to all water provider participants in the RWSP except the cities of Sandy and Canby. These cities also have mandatory urban growth boundaries, as required by Oregon planning program statutes and rules. In addition, Metro manages some of the region's open space programs, solid waste, and convention centers. As the water providers began to examine regional water supply needs, Metro also began a program to refine its urban growth management strategies. Called "Region 2040," it includes adoption of a long-range growth concept, a vision statement, and a Regional Framework Plan.

The region's water providers have designed the RWSP to meet the urban growth management programs as adopted by Metro, and the demand forecast is based upon growth projections provided by Metro. Metro became a formal RWSP participant in mid-1994. Subsequently, the Metro Council agreed to be a part of the RWSP adoption process along with all of the region's water providers. In the summer of 1995, the regional water provider participants began a dialogue with Metro staff, advisory committees, and Council about the future roles and relationships of the water providers and Metro, particularly after the RWSP's adoption.

The region's water providers requested and Metro adopted specific language in the Regional Urban Growth Goals and Objectives (RUGGOs) that details the requirement of the Metro Charter to adopt an Urban Water Supply and Storage Element in its Regional Framework Plan. The language would require Metro to base its water supply plan element on the adopted RWSP.

The region's water providers anticipate that Metro will join the regional consortium. Some of the functions of the consortium listed above are intended to refine the respective roles of the region's water providers and Metro. The following priorities for defining mutual roles are recommended as a part of this plan:

- The region's water providers and Metro should work to develop an ongoing, mutually supportive partnership.
- The number of water providers in the region presents an obstacle to putting a coordinated water supply plan and implementation strategy into action. If adopted by a significant majority of water providers, the RWSP will establish a document that reduces these barriers and provides a mechanism to ensure that water supply needs are met in a coordinated and efficient manner that recognizes a broad range of expressed public values.

- The region's water providers recognize Metro's overarching responsibilities for growth management. The RWSP is developed and will be revised based upon Metro's demographic and employment projections and on adopted elements of Metro's growth strategy. The RWSP also will be evaluated over time to reflect Metro's updated growth projections, the UGB, the Regional Framework Plan, and local comprehensive plans. The region's water providers do not wish to be placed in a position of either restricting approved growth patterns or encouraging inappropriate growth. Metro's role is important to the RWSP's development, adoption, and revision over time.
- Given the water providers' responsibility for supplying water, they will finance and construct any necessary improvements. They should provide the primary plan and strategies of any Urban Water Supply Element of the Regional Framework Plan for Metro's adoption or update.
- Metro is a participant in the RWSP and is a part of the adoption process. This ensures that Metro's concerns will be considered as the RWSP is developed, adopted, and updated.
- Metro's regional role in facilitating water conservation should be developed jointly, with participation by the region's water providers, wastewater agencies, and Metro.

CONCLUSION

The development of the Regional Water Supply Plan has taken a number of years to accomplish and could not have been done without the leadership and dedication of the region's water providers to continue regional cooperation. The Plan takes a balanced approach to meeting the region's future water needs and is based on an important public involvement effort to understand the public's primary policy values. The water providers then used these policy values as the centerpoint for the development of alternative resource program strategies. The strategy for meeting the region's future water needs is based on what the decision makers of the 27 entities involved in this planning effort felt was important after they had an opportunity to hear from their involved citizens.

First and foremost the plan emphasizes conservation, water use efficiency, non-traditional sources of supply (aquifer storage and recovery and non-potable supplies), and transmission interconnection to utilize existing sources before the development of new regionally significant sources of supply. There is significant work ahead to implement the plan in a timely and responsive manner.

The region's water providers are committed to implementing this plan. They recommend formation of a regional water providers consortium to continue the regional cooperation which has heralded the development of this plan. The region will need the individual entities to act in a continuing partnership effort in order to implement the plan in a manner which will avoid higher economic costs and significant environmental impacts. Together with Metro, the region's water providers are prepared to continue the regional dialogue, both among themselves, and with the public, to ensure that this plan continues to reflect the values of both current and future residents.

APPENDICES

Appendix A
REFERENCES

REFERENCES

REGIONAL WATER SUPPLY PLAN

Barakat & Chamberlin, Inc., *Results of Economic Screening of Conservation Measures*, April 1994.

Barakat & Chamberlin, Inc., *The Value of Water Supply Reliability: Results of a Contingent Valuation Survey*, Technical Report, May 1994.

Barakat & Chamberlin, *Conservation Program Descriptions—Final Report*, May 17, 1995.

Barakat & Chamberlin Inc., *Water Conservation Universe of Measures and Qualitative Screen*, October 1993.

Barakat & Chamberlin Inc., *RWSP Demand Management and Conservation Element*, July 7, 1994.

Barakat & Chamberlin, Inc., *Final Draft—Conservation Measure Technology Profiles*, May 11, 1994

Barney & Worth, Inc., *Regional Public Information and Involvement Plan for Phase 2 of the Regional Water Supply Plan*, September 1993.

Barney & Worth, Inc., *Stakeholder Interview Report for Phase 2 of the Regional Water Supply Plan*, October 1993.

CH2M Hill, *Water System Demand Study*, 1991.

McArthur & Associates, *Public Opinion Research*, March 1994.

McArthur & Associates, *Focus Group Research*, June 1995.

Montgomery Watson, *Review of Existing Information and Assumptions*, August 1993.

Montgomery Watson, *Willamette River Water Treatment Pilot Study*, prepared for the Tualatin Valley Water District, August 1994.

Montgomery Watson, *Water Quality Analysis*, Technical Report, February 1994.

Montgomery Watson, *Water Treatment Analysis*, Technical Report, May 1994.

Montgomery Watson, *Summary of Sub-Regional Supply Sources*, May 1994.

Montgomery Watson, *Aquifer Storage & Recovery Detailed Analysis Report*, May 1994.

Montgomery Watson, *Surface Water Availability*, Technical Report, July 1994.

Montgomery Watson, *Memorandum to Gary Fiske, from Garry Wohlgemuth; Phase 2 Wastewater Reuse—Evaluation as a Supply Side Resource*, May 23, 1994.

Murray Smith and Associates, Inc., *Evaluation of Water Rights and Water Use Permitting Requirements*, March 10, 1994.

Murray, Smith & Associates, Inc., *Definition/Analysis of Existing Infrastructure*, February 1994.

Murray, Smith & Associates, Inc., *Regional System Efficiency and Transmission Element, Task 1: Definition and Analysis of Existing Infrastructure*, February 8, 1994.

Murray, Smith and Associates, Inc., *Regional System Efficiency and Transmission Element: Task 3 Development of Regional Transmission and Storage Facility Options, Final Interim Technical Memorandum*, August 1995.

Parametrix, Inc., *Appendix I, Subtask 4.2 Bull Run Dam No. 3., Preliminary Site Selection of Potential Dam Sites Comparative Environmental Analysis*, October 1993.

Parametrix, Inc., *Environmental Analysis of Future Water Source Options*, December 1994.

Squier Associates, Inc., *Bull Run Dam No. 3 Preliminary Site Selection Evaluation of Potential Dam Sites*, February 3, 1994.

Squier Associates, Inc., *Preliminary Site Evaluation of the Log Creek Dam Site, Bull Run River*, April 19, 1995.

Squier Associates, Inc. and Montgomery Watson, *Screening of Potential Aquifer Storage and Recovery Areas*, January 31, 1994.

Squier Associates, Inc. and Montgomery Watson, *Bull Run Dam No. 3 Preliminary Site Selection Evaluation*, February 1994.

OTHER

American Water Works Association, *Integrated Resource Planning: A Balanced Approach to Water Resources Decision Making*.

Black & Veatch in Association with Lee Engineering, *Columbia River Water Treatment Pilot Study*. Prepared for Rockwood Public Utilities District, May 20, 1994.

CH2M Hill, *Water Source Options Study*, February 1992.

CH2M Hill, *Tri-County Pipeline System Conceptual Study*, February 1992.

Economic and Engineering Services, Inc., in association with Richard Bennett, CH2M Hill, Jeanne Lawson Associates, and the Xeris Group, *City of Portland, Water Conservation Study*, February 14, 1992.

HDR Engineering, Inc., in association with Barney & Worth, Inc., Cascade Earth Sciences, CH2M Hill, Jeanne Lawson Associates, Public Financial Management, Robert A. Gearheart, and Wetland Management Services, *Recycled Wastewater Master Plan-Draft*, Unified Sewerage Agency of Washington County, August 1991.

Hegwald, Leslie, Mid-Willamette Valley Council of Governments, Personal Communication, May 11, 1995.

Kennedy Jenks Consultants, *Final Evaluation of Water Reuse, Direct Use Alternatives—Bull Run Water Supply System*, prepared for the City of Portland Bureau of Water Works, September 1993.

KOLLT Report 2, Final, May 1, 1994.

Metropolitan Planning District, *The Regional Forecast, Portland-Vancouver Metropolitan Area: Forecast 1990-2040*, November 1993.

Metropolitan Planning District, *Region 2040 Recommended Alternative Decision Kit*, September, 1994.

Montgomery Watson, *Willamette River Water Treatment Pilot Study*, prepared for the Tualatin Valley Water District, August 1994.

Montgomery Watson, *Water Treatment Pilot Study*, prepared for Portland Water Bureau, April 1992.

Oregon Water Resources Department, *Willamette Basin Report*, 1992.

Portland Water Bureau in Partnership with the Region's Water Providers, *Water Supply—2050 Portland Metropolitan Region*, February 1992.

R2 Resource Consultants, prepared for Portland Bureau of Water Works, Review of Regional Water Supply Plan (RWSP), *Fish Resource Impact Ratings for Bull Run Dam 3 Water Supply Options*, March 1996.

U.S. Geological Survey, *Statistical Summaries of Streamflow Data in Oregon: Volume 1—Monthly and Annual Streamflow and Flow-Duration Values*, Open File Report 90-118, 1990.

U.S. Army Corps of Engineers, Portland District, *Final Environmental Impact Statement, Barney Reservoir Expansion*, May 1994.

Appendix B
DEVELOPMENT OF EVALUATION RATINGS

DEVELOPMENT OF EVALUATION RATINGS

Tables B-1 through B-4 show the manner in which the ratings for each source options against the evaluation criteria were developed. Several of the ratings are themselves composites of other ratings. In a few cases, those subcomponents in turn are built up from lower level ratings.

For example, as illustrated in Table B-1, the rating for raw water quality is an average of ratings for seven constituents. As shown in Table B-2, the overall rating for impacts to the natural environment are based on ratings for each of the five natural environment components (fish, geotechnical and natural hazards, threatened and endangered species, wetlands, and wildlife & habitat). The rating for fish impacts, in turn, is a composite of ratings on instream flows, fish habitat, threatened and endangered species impacts, and impacts on non-T&E species.

In cases where it is felt that adverse ratings on any one of the subcomponents would disproportionately affect the composite rating, a weighting procedure was used to combine the subcomponent ratings. These are indicated in the tables by the phrase "weighted average" rather than the word "average."

In those cases, the formula used to combine the subcomponent ratings was as follows:

$$\text{Composite rating} = \frac{\text{Rating}_1^3 + \text{Rating}_2^3 + \dots + \text{Rating}_n^3}{\text{Rating}_1^2 + \text{Rating}_2^2 + \dots + \text{Rating}_n^2}$$

**Table B-1
COMPONENTS OF RAW WATER QUALITY AND AESTHETICS RATINGS**

Source Option	RAW WATER QUALITY										AESTHETICS		
	Physical	Inorganics	Organics		Micro-biological	Nutrients	Radio-nuclides	Average	Hardness	Taste & Odor	Average		
			DBP Precursors	Synthetics									
Bull Run Dam 3	1	1	2.5	1	1	1	1	1.2	1	1	1.0		
Columbia	2	2	2.5	2	2	2	2	2.1	3	2	2.5		
Willamette	2	2	2.5	2	3	3	1	2.2	2	2	2.0		
Clackamas	2	1.5	2.5	1.5	2	2	1	1.8	2	2	2.0		

Note: Ratings range from 1 to 5; lower scores are preferred.

**Table B-2
COMPONENTS OF NATURAL ENVIRONMENT RATING**

Source Options	Fish							Threatened & Endangered Species (Other Than Fish)	Wetlands	Wildlife & Habitat	Weighted Average
	Instream Flows	Fish Habitat	Threatened & Endangered Species	Non T&E Species	Weighted Average	Geotechnical and Natural Hazards					
Bull Run Dam 3*	N/A	5.0	3.0	5.0	4.7	1	5	5	5	4.9	
Columbia	1.0	1.0	1.0	1.0	1.0	3	1	0	0	2.6	
Willamette	1.0	1.0	1.0	1.0	1.0	1	1	0	0	1.0	
Clackamas (> 50 mgd)	3.0	3.0	3.0	3.0	3	1	1	1	1	2.4	
Clackamas (≤50 mgd)	1.0	1.0	1.0	1.0	1.0	1.0	1.0	1.0	1.0	1.0	
ASR	1.0	1.0	1.0	1.0	1.0	1.0	1.0	2.0	1.0	1.5	

Note: Ratings range from 1 to 5; lower scores are preferred.

* Scores for this option do not factor in potential to provide environmental mitigation or enhancement.

**Table B-3
COMPONENTS OF HUMAN ENVIRONMENT RATING**

Source Option	Cultural	Hazardous Materials	Land Use			Recreation Resources	Scenic Resources	Weighted Average
			Non-Compatibility	Inconsistency	Weighted Average			
Bull Run Dam 3	1.0	1.0	1.0	4.5	4.3	1.0	3.0	3.6
Columbia	1.0	3.0	1.0	1.0	1.0	0.0	1.0	2.5
Willamette	1.0	3.0	0.0	1.0	1.0	0.0	1.0	2.5
Clackamas	1.0	1.0	1.0	1.0	1.0	1.0	1.0	1.0
ASR	1.0	1.0	1.0	3.0	2.8	1.0	1.0	2.2

Note: Ratings range from 1 to 5; lower scores are preferred.

Table B-4
COMPONENTS OF VULNERABILITY TO
CATASTROPHIC EVENTS RATING

Source Options	Volcanic	Slide	Spills	Fire	Average
Bull Run Dam 3	4 [1]	4	1	5	3.5
Columbia	5	1	5	2	3.3
Willamette	3	1	4	2	2.5
Clackamas	2	3	2	3	2.5
<p>[1] Bull Run vulnerability to a volcanic event would be substantially reduced if the Sandy River conduit crossings were reinforced. Note: Ratings range from 1 to 5; lower scores are preferred.</p>					

Appendix C
DEMAND FORECASTING METHODOLOGY

DEMAND FORECASTING METHODOLOGY

OVERVIEW OF THIS TECHNICAL APPENDIX

This appendix presents a conceptual and technical overview of the water demand forecasting model prepared for the Portland Regional Water Supply Study. This appendix also provides documentation with respect to adapting the regional model to the specific forecasting needs for the City of Portland Water Bureau.

The first section of this appendix addresses the conceptual framework used to develop and implement the demand forecast model. It specifically addresses:

- Improvements of this model over previous demand forecast models developed for the Portland metropolitan region;
- Econometric modeling of water demand;
- Vintaging and naturally occurring water conservation;
- Peak day water demands; and
- The model's treatment of uncertainty.

The second section of the appendix describes the data used to develop and model water demands. Included is a discussion of the various sources and types of data collected, a description of units of measurement particular to this model, and storage of this data in SAS dataset format.

PHASE 2 WATER DEMAND FORECAST FRAMEWORK

Calibration of Billing Data to Production Data

For each agency our first task was to calibrate customer sales to water production. We used a distributed lag model to adjust sales per customer class by distributing it across previous ("lagged") periods of production. This distribution is given by the regression coefficients for each lagged production variable in the model. The number of lagged production periods was largely determined by the number of months in each water agency's billing cycle. The general form of the model is:

$$\text{SALES}_i = f(\text{INT}, \text{PROD}_i, \text{PROD}_{i-1}, \text{PROD}_{i-2}) \quad (1)$$

where

SALES_i is the calibrated sales per customer class in month i ;
 INT is the regression intercept; and
 PROD_i is total production in the relevant subregion in month i .

Adjusted billing demand for each class is given by summing the regression coefficients for lagged production and multiplying this sum by the production total in each month, then adding the intercept term. We refer to this as production-normalized sales.

The theoretical reason for normalizing sales to production is to redistribute water demand to the period in which it was consumed, instead of the period in which it was billed. The practical result of this calibration method is that it shifts each year's sales peak backwards one or two months. This is the desired effect, since billing demands are a composite of actual consumption from one and two months prior.

Usage Per Customer Framework

The next task was to convert sales into sales per account for each customer class. This removed the effect of population growth and account variation from the regression portion of the forecasting framework. Alternative population growth scenarios by customer class and provider were considered directly in the uncertainty analysis.

Class-specific sales histories of three years or longer were developed from data provided by 15 jurisdictions. These jurisdictions include: Tualatin Valley, Forest Grove, Hillsboro, Clackamas, Mount Scott, Oak Lodge, Clairmont, West Linn, Canby, Oregon City, Portland, Sandy, Troutdale, Gresham, and Rockwood.

Weather Impacts

The influence of weather on water demands was determined by applying two types of variables in the econometric framework. The first type is a seasonal index of water consumption, which captures the impact of normal weather on per customer usage

each month.³⁷ The second type of variable captures the impacts of deviations from normal weather on water usage.

The first step in developing the seasonal index was to calculate a thirteen-month moving average of water sales. The current month, the previous six months, and the subsequent six months were averaged to derive this moving average.³⁸

The second step was to divide calibrated sales for each period by the moving average for that period. This estimates the ratio of actual sales to moving average sales. Then the ratios for each month across all the years in the analysis (i.e., all the January's, all the February's, and so on) were averaged. For example, we averaged the ratio for January 1984, January 1985, and so on through January 1992. This yields the average ratio of actual January sales to moving average January sales. Applying this method to each month provides a stream of 12 constants representing a "normalized" cyclical pattern of consumption.

Deviations from normal weather were derived from Portland Airport and North Willamette Experimental Weather Station (NWES) weather data. Normal weather is given by the average values from 1961 to 1992 for daily precipitation and for daily average temperature. The NWES data was used for Clackamas County-based providers, and the Portland Airport weather was used for all other providers.

Exploratory Analysis and Model Development

The econometric models initially included economic variables (water prices, economic activity) along with weather variables. Jurisdiction-specific regression models for residential and nonresidential customer classes were based on the following equations:

³⁷This approach is based on previous research by Jack Weber of Montgomery Watson. See "Final Report: Conservation Rate Study, Tualatin Valley Water District," by Montgomery Watson, completed June 1993; "Forecasting Demand and Measuring Price Elasticity," published by *Management and Operations*, May 1989.

³⁸We refer to previous periods as lags, and to subsequent (or future) periods as leads. Prior to calculating the moving average, the sixth lag and the sixth lead were initially divided by 2. In this way, the impact of these outer periods on the moving average was reduced. Then the six lags, the six leads, and the current month's sales were added, and the sum was divided by 12.

Residential: $NSPA = f(SI, DPRECIP, DTMEAN, DPCPSUM, DTMNSUM, RATE, INCOME)$ (2)

Nonresidential: $NSPA = f(SI, DPRECIP, DTMEAN, DPCPSUM, DTMNSUM, RATE, EMP)$ (3)

where

NSPA is the calibrated sales per account;

SI is the seasonal index of normal consumption;

DPRECIP is the deviation of daily precipitation from the 30 year average;

DTMEAN is the deviation of average daily temperature from the 30 year average;

DPCPSUM measures the additional impact of DPRECIP in summer months;

DTMNSUM measures the additional impact of DTMEAN in summer months;

RATE is the real price of water by class and provider;

INC is per capita county income; and

EMP is county employment.

Exploratory analyses indicated that seasonal usage patterns and deviations from normal weather were key drivers affecting per customer water usage across all customer classes. The economic drivers were inconsistent in these regressions. In most cases the coefficients had the wrong sign or were statistically insignificant. This was probably due to the fact that water prices and economic activity in the Portland area were fairly stable and exhibit little variation over the historical billing period. As with population growth, hypothetical water price changes were addressed in the uncertainty analysis.

Development of Gross Water Demand Forecast per Customer

Development of the econometric/gross forecast model per customer consisted of three additional steps:

- Estimate final regression models (without price, income, and employment) for each class and provider.
- Apply the appropriate regression model(s) and other data to providers that did not have class-specific billing data and develop “synthetic” estimates of historical water usage for each class, jurisdiction, and county.
- Calibrate (and revise as necessary) the synthetic estimates to historical data for each provider based on the following jurisdiction-specific parameters:
 - Average annual sales
 - Average monthly sales
 - Ratio of peak month sales to average annual sales

The gross water demand methodology developed in this section should be viewed as the starting point for water forecasting. It represents a “business-as-usual” case where total consumption is driven by the seasonal usage patterns, the weather, and the number of customers. Per customer usage is constant over the forecast horizon.

Development of Gross Water Demand Forecast

After developing the econometric models for sales per customer, we estimated the total demand forecast by multiplying sales per customer by the number of customers in each customer class served by each provider. The number of customers per class and provider were estimated in the following way:

- We collected billing data from each provider, including number and type of customer classes, and customers per class in January 1992.
- We calculated average annual growth rates (AAGR) between 1992 and 2040 for households and employment for each provider’s service area, based on Metro’s regional land use planning model. Specifically, the Preferred Alternative scenario was used as the final regional land use scenario.³⁹ Since Metro did not forecast growth through 2050, we assumed that growth from 2040 to 2050 would follow the same growth rates as in the 1992 to 2040 period.

³⁹These estimates are available from Stuart Todd at Metro.

- We estimated the number of accounts per residential class (single-family, multifamily, and apartments) in each year through 2050 as the sum of the previous year's accounts plus the compounded increase indicated by the AAGR. We interpolated the monthly number of accounts within each year as a straight-line average between December of the previous year and December of the current year.
- We also estimated high and low growth scenarios based on Metro's alternative population scenario simulations. Metro estimated the high and low potential growth for the region relative to the baseline forecast.⁴⁰
- We calculated the ratio of 2040 high and low scenarios to the baseline from Metro's forecast and applied this ratio to the provider billing data to estimate the high and low number of customers for each customer class and provider in 2040. We then recalculated the AAGR for high and low scenarios for each customer class.

Vintaging and Naturally Occurring Water Conservation

Changes in water services technologies, through building codes, appliance standards, and the competitive marketplace, will impact per customer water consumption over time. Technological change will reduce usage as processes and equipment efficiently using scarce resources replace less efficient equipment types. We refer to all of these changes, whether driven by the marketplace or regulation, as naturally occurring conservation. Naturally occurring conservation covers the installation and use of all water saving technologies that is independent of provider-sponsored programs.

Building and Equipment Vintaging

Barakat & Chamberlin's approach to developing estimates of naturally occurring conservation relied on the turnover or vintaging of buildings and equipment. We combined information on the expected lives of buildings and equipment, the saturation rates of water using equipment, the penetration rates of efficient and inefficient equipment within each end use, and the expected consumption of each end use.

⁴⁰Metro (1993). *The Regional Forecast: Portland-Vancouver Metropolitan Area Forecast 1990-2040*. Available from Metro's Planning Department (Data Resource Center).

The vintaging model starts with penetration and saturation rates of each end use by efficiency level. Estimates of water usage change over time with the growth of the building stock in each jurisdiction, the natural decay of existing building stock, and the turnover of end-use equipment.

Customer classes were separated into three groups. Residential customers comprise the first, where naturally occurring conservation affects major indoor end uses, and where information on end use consumption and penetration rates were readily available. The second group consists of commercial customers where a number of end uses will likely be impacted, but little information is available on individual end-use consumption. The last group is comprised of classes, such as industrial and agricultural customers, where naturally occurring conservation was expected to have little impact on per customer consumption.

Market Share Assumptions

Residential plumbing codes for the Tri-County area began affecting the efficiency of water-using equipment in 1978 by requiring toilets to have a minimum efficiency of 3.5 gallons. Later codes further affected the efficiency of toilets, showerheads, and faucets. Clothes washers and dishwashers are not covered by plumbing codes, but clothes washers are affected by energy standards that reduce the amount of water used. Efficiency standards in commercial, toilets, faucets and showerheads have also increased throughout the 1980s.

Information also exists on new technologies' introduction and market share throughout the last 15 years. Applying secondary data and conversations with manufacturers and experts in the field, we estimated the annual market shares of each technology and efficiency type. Table 1 contains our assumptions of market shares for low, medium, and high efficiency equipment from 1977 through 2000.

**Table C-1
PENETRATION RATES OF END-USE EQUIPMENT**

	Low Efficiency	Medium Efficiency	High Efficiency
Toilets			
Pre-1978	100%		
1978		100%	
Post-1991			100%
Faucets			
Pre-1980	100%		
1980-1983		100%	
1984-1991		25%	75%
Post-1991			100%
Shower			
Pre-1980	100%		
1980-1983		100%	
1984-1991		40%	60%
Post-1991			100%
Clothes washer			
Pre-1982	100%		
1982-1991		100%	
1992-2000		98%	2%
Post-1991		95%	5%
Dishwasher			
Pre-1982	100%		
1982-1991	40%	60%	
Post-1991		90%	10%

Equipment Lifetimes

The changing composition of equipment efficiencies in the population is dependent on the turnover of old equipment and the addition of new housing as well as on the efficiency of new equipment. Existing equipment turnover is dependent on the expected useful lifetime of the equipment. Barakat and Chamberlin's assumptions about equipment lifetimes were developed by contacting manufacturers and experts in the field. The results are displayed on Table 2. Using this information, the vintaging model simulated the increasing penetration of more efficient equipment in the residential households of each jurisdiction over time.

Table C-2
EQUIPMENT LIFETIMES IN YEARS

End Use	Number of Years After Which 50% of End Uses Remain	Number of Years After Which 10% of End Uses Remain
Toilet	25	45
Showerhead	10	20
Faucet	15	25
Clothes washer	8	14
Dishwasher	7	13

Forecasting Existing and New Building Stocks

The annual account estimates used to forecast the initial demand for each jurisdiction and each residential class are used as a proxy for total annual building stock. New buildings are the difference between each year's total building stock and still existing building stock from the previous year. This is not the simple difference between the total building stock in the one year and the previous year, as some of the existing buildings will have been destroyed, completely gutted and renovated, or removed from the system in the course of a year. How many existing buildings are replaced each year depends on the stock of vintages and the overall decay rate.

Decay rates of existing 1992 base year stock and new stock were specified. Two different decay rates were specified, as the existing base year building stock was an

amalgam of vintages rather than buildings constructed in one year. An exponential decay function was specified for the 1992 building stock in the form:

$$S_t = S_b * (1-r)^t \quad (4)$$

where

S_t = Stock in year t
 S_b = Stock in 1992
 r = Annual decay rate

The decay rate is 0.005, causing one-half of one percent of the remaining 1992 stock to be removed each year. At this rate, 50% of the existing buildings will have been replaced or renovated in 140 years.

Due to its homogeneity of being built in one year, new building stock is assumed to have a logistic decay rate. The logistic function is a S-shaped curve that results in a small decay rate the first years, then increases dramatically before tapering off. The default logistic decay function is:

$$S_t = S_k * (1 - (1 / (1 + e^{(a+b*t)}))) \quad (5)$$

where

S_t = Stock in year t
 S_k = Stock of new buildings in base year k
 a, b = Logistic function parameters

The parameters a and b are set by specifying the periods and stock percentages remaining for any two years. The selected years 20 and 100 are respectively associated with 99% and 50%. This specification assumes that 99% of the building stock remains twenty years after construction, and that 100 years after construction only 50% of the buildings remain. The time period and the survival rates are then inserted into the above equation, producing two simultaneous equations:

$$\begin{aligned} 0.99 &= 1 - 1 / (1 + e^{(a+b*20)}) \\ 0.5 &= 1 - 1 / (1 + e^{(a+b*100)}) \end{aligned}$$

The two unknowns are estimated and solved for the equations:

$$b = ((\ln(0.99 / (1 - 0.99)) - \ln(0.5 / (1 - 0.5))) / (20 - 100)) = -0.05743$$

$$a = \ln(0.5 / (1 - 0.5)) - b * (100) = \ln(0.5 / (1 - 0.5)) - (-0.057) * (100) = 5.74$$

To visualize how the vintaging model operates, assume that the base year building stock and each subsequent year of new buildings are separate stocks with different decay rates (Table 3). Each year's new buildings are the difference between the total number of buildings forecast minus the existing building stock. These new buildings are the first entry in each column except for the total and 1992 stock. The existing building stock is the sum of the remaining 1992 base year building stock and the remaining building stock for each earlier year of new construction.

**Table C-3
DISTRIBUTION OF BUILDING STOCK BY YEAR: AN EXAMPLE**

Year	Total Stock	1992 Stock	1993 Stock	1994 Stock	1995 Stock	1996 Stock
1992	10,000	10,000				
1993	10,150	9,950	200			
1994	10,302	9,900	199	202		
1995	10,457	9,851	199	202	204	
1996	10,614	9,801	199	201	204	207

Mathematically this the new building stock is:

$$\text{New}_t = \text{Total}_t - S_b * (1 - r)^{(t)} - \sum S_k * (1 - (1 / (1 + e^{(a+b*t)}))) \quad (6)$$

New_t = New construction year t

Total_t = Total building stock year t

S_b = Stock in base year

r = Annual decay rate

S_k = Stock of new buildings in year k where $k < t$

a,b = Logistic function parameters

Forecasting Equipment Stocks

Equipment stocks are forecasted with similar methods. In the case of each end use three different stocks are forecast for each efficiency level. The new equipment stock installed each year are dependent on the growth and decay in housing, the natural replacement cycle of equipment, and the penetration rates of efficiency types. Housing and equipment decay are independent of each other. As with the building stock, decay rates for existing and new equipment take two different functional forms. Base year equipment stocks decay according to the specified turnover rate, while new equipment decays according to the logistic rate.

The initial penetration rates are estimated by utilizing each jurisdiction's annual average housing growth rate during the 1980s, then backcasting using the vintaging model. Regional averages were considered inappropriate as almost half the housing in some jurisdictions was built during the 1980s. This resulted in differing base year equipment efficiency penetration rates for each jurisdiction. Saturation rates were assumed to be 100% for all end uses except clothes and dishwashers. Initial clothes and dishwasher saturation rates were estimated using data from the Pacific Northwest Residential Appliance saturation survey of 1988, and the 1988 Residential Portland Water Bureau Survey. Saturation rates were allowed to increase on the assumption that all appliances that removed from the existing stock would be replaced, and all new buildings would install them.

An example of the changing stock levels for toilets and showerheads can be seen on Table 4. The penetration level for each efficiency type is set in 1992, the base year of the forecasts. Plumbing code requires that only high-efficiency toilets and showerheads are installed after the beginning of 1992. Due to this change in the building code, the share of high efficiency equipment in each year's total existing equipment stocks increases over time. The model assumes that negligible numbers of low and medium efficiency equipment have been installed since 1991.

**Table C-4
DISTRIBUTION OF EQUIPMENT STOCK BY YEAR AND
BY EFFICIENCY LEVEL: AN EXAMPLE**

Year	Low Efficiency Shower Heads	Medium Efficiency Shower Heads	High Efficiency Shower Heads
1992	1,912	1,420	1,727
1993	1,817	1,349	1,980
1994	1,726	1,282	2,226
1995	1,640	1,218	2,465
1996	1,559	1,157	2,699
1997	1,481	1,100	2,928
1998	1,407	1,045	3,151
1999	1,337	993	3,369
2000	1,271	944	3,583
2001	1,207	897	3,793
2002	1,147	852	3,999
2003	1,090	810	4,202
2004	1,036	769	4,402
2005	984	731	4,598
2006	935	695	4,792
2007	889	660	4,984
2008	845	627	5,173
2009	803	596	5,361
2010	763	566	5,547

Forecasting Consumption with Naturally Occurring Conservation

Two steps were required to complete the water demand forecast net of naturally occurring conservation:

- We applied the account vintage model to the forecasted water accounts (based on Metro and provider data) by class for each agency.
- We used the end-use vintage model and end-use consumption and saturation profiles to determine a naturally-occurring “net” sales forecast for each agency.

Information on water consumption by various end use equipment types was primarily derived from the seminal 1984 Brown and Caldwell study for the U.S. Department of Health and Urban Development. Average per capita per day consumption levels were estimated for each equipment type (Table 5). The equipment stocks forecast were then used to estimate saturation rates for each year, and to estimate a weighted average per capita per day consumption level for each end use.

**Table C-6
PER CAPITA DAILY CONSUMPTION**

	Low Efficiency gpd	Medium Efficiency gpd	High Efficiency gpd
Toilet	22	14	6.4
Shower	16.3	12.5	8.2
Volumetric Faucet	11.6	7	6
Non-Volumetric Faucet	1.7	1	1.7
Clotheswasher	16.5	13.2	8.4
Dishwasher	2.4	2	1.3

Average nonseasonal base load consumption per account was estimated by taking the average daily consumption for the period November through April. Seasonal consumption was the additional consumption over and above the base load consumption in May through October.

Miscellaneous end-use consumption was the difference between the average nonseasonal base load consumption per person and the total weighted consumption per person of end uses being tracked. As exact information on the number of persons per account was missing, the estimation was performed at the county level. This resulted in miscellaneous consumption constituting approximately 10% of the total base load.

The changing base load consumption over time was calculated by holding miscellaneous consumption, seasonal consumption, and the number of people per account constant. This change came about solely due to the increased penetration of high efficiency equipment in the building stock.

Little information was available for the water usage of commercial buildings. With codes affecting the efficiency of some plumbing fixtures, it was expected that commercial water use would be reduced on the per employee basis. Therefore, to model these efficiency improvements, it was determined that all new accounts and toilets would lead to a 5% decrease in the nonseasonal base load. With 50% decreases in toilet consumption, this 5% reduction is deemed quite conservative.

Unaccounted-For Water Demand

Unaccounted-for water typically includes water used for fire plugs, some municipal uses, and water distribution system maintenance. We estimated the unaccounted-for water percentage for each provider based on a comparison of the sum of billed sales for all customers across all providers served by each producer with the total amount of water coming through the start of the distribution system (sometimes called "headworks").

Since this comparison process required aggregation of water sales to a monthly timestep, it is possible that a loss of precision could have occurred during the unaccounted-for water estimation. Therefore, we routinely rounded the ratio of unaccounted-for water to total billed sales to five percent increments.

Peak Day Water Demand Forecast

Our approach to estimating peak day demands builds upon the approach used in the Phase 1 study, and consists of three steps:

- For each agency we started with the agency-specific peaking factors from Phase 1. These factors show the ratio between peak day usage and average daily usage based on normal weather. Using this annual load factor, a gross estimate of peak day water demands was developed for each provider.

- The next step was to convert the annual load factor to a peak month load factor under normal weather. This is given by dividing peak day usage by peak month usage.
- The final step is to develop “design day” peak demand estimates for each provider. This was estimated through the following formula:

$$\text{Design Peak Day demand}_{jt} = AA_{jt} * PF_{jt} * PMWA_{jt} * RPSAAA_{jt} \quad (7)$$

where for provider j and year t,

AA = Annual Average demand (measured in millions of gallons per day)

PF = Peak Factor

PMWA = Peak Month Weather Adjustment, and

RPSAAA = Ratio of Peak Season to Annual Average Adjustment

The annual average demand is a summary measure of the consumption of all customers of each provider in gallons per day. The peak factor is a ratio of demand on the peak day to the annual average (usually between 1 and 3).

The peak month weather adjustment is defined as the ratio of peak month demand under an extreme weather condition to peak month average weather demand. The extreme weather condition was simulated by estimating water demand for monthly precipitation and temperature at 95 percent confidence limits. This term captures the adjustment for peak weather conditions coinciding with peak water demands for planning concerns.

The ratio of peak season to annual average adjustment is a term used to capture the inherent change in the importance of the peak season as naturally occurring conservation continues to penetrate the market. Since naturally occurring conservation chiefly affects the residential customer classes with respect to indoor end uses only, the share of total demand represented by outdoor end uses is likely to grow over time. This implies that the ratio of the peak season to the annual average will also grow over time. As peak season demands become relatively larger, this will have an upward effect on the peak day factor, which is what this adjustment is intended to capture.

Treatment of Uncertainty

All forecasts and associated models are subject to uncertainty, including model structure, model parameters, and forecast drivers. In this study Barakat & Chamberlin concentrated primarily on uncertainty in population and employment drivers to develop two alternative scenarios: (1) A high growth, high demand case; and (2) A low growth, low demand case.

A secondary area of concentration here was price elasticity. As reasonable price elasticity estimates could not be generated with the econometric model from historical data, Barakat & Chamberlin used price elasticity information from secondary sources and applied real price increase assumptions to the alternative scenarios.⁴¹

Table 6 summarizes the elasticities and how we applied them in this study. Given the large projected reductions in indoor use in residential and multifamily buildings, winter elasticities were reduced by 50% to avoid double counting.

**Table C-6
PRICE ELASTICITY ASSUMPTIONS**

Customer Class Type	Long-Run Elasticity without Conservation	Assumption for Forecast Model
Residential (Single-Family)		
Indoor/Winter	-0.1	-0.05
Outdoor/Summer	-0.3	-0.3
Residential (Multifamily)		
Indoor/Winter	-0.05	-0.025
Outdoor/Summer	-0.1	-0.1
Nonresidential		
Indoor/Winter	-0.2	-0.15
Outdoor/Summer	-0.2	-0.2

⁴¹In particular, we relied on a recent literature survey of price elasticity estimates developed by Ben Dziegielewski, "Estimating Price Elasticity of Demand For Water: The Impact of Conservation Rate Structures," in *Rate Structures to Promote Conservation*, Proceedings of A Conference Organized by the Delaware River Basin Commission and the New York City Water Board, 1990, pp. 11-27.

All price increase scenarios in the forecast refer to real price changes other than those associated with potential resource options considered in this study. Thus, possible price changes from sewage treatment, environmental compliance, and fixing an aging distribution system are included, but new water source options are not included.

The most likely case assumes a 0.25% annual real increase in water prices, or about 16% higher relative to 1992 prices by the year 2050. The low case assumes an even greater annual increase of 0.5%, or about 34% higher relative to 1992 prices by the year 2050. The high demand case assumes no increase in water prices.

PHASE 2 WATER DEMAND FORECAST DATA

Barakat & Chamberlin collected four types of data to support the forecast development, including water sales, water production, weather, and economic data. This section describes the data sources and treatment.

Water Sales Data

We developed a comprehensive data collection instrument to gather a variety of information about each of the water providers participating in this study. This instrument was mailed to specific contacts at each of the 30 agencies. We asked for the following pieces of information:

- For the period January 1989 through December 1992, monthly totals of water sales, number of accounts, and revenues for each customer class.
- For the period January 1983 to December 1988, monthly totals of water sales, number of accounts, and revenues aggregated across all customer classes.
- The estimated monthly sales in 1991 for the top 10% and top 20% of residential class customers, including total sales and number of accounts in each group, for each residential class served by the agency.
- The estimated monthly sales in 1991 for each of the customers in the top 10% of each nonresidential class, including total sales and name of the customer (where available).

- A written description of each customer class, including a definition of what types of customers occupy each class (e.g., residential single-family, industrial, municipal, etc.).
- A copy of all rate schedules in effect since 1983.
- A brief description of sewer and storm water charges.
- Descriptions of any existing, prior, or planned conservation and/or curtailment programs.
- An estimate of unaccounted-for-water (i.e., simply the difference between production or wholesales and retail sales).
- Any future water sales projections developed by the agency.
- A map of the agency's service area.
- A list of providers to whom the agency wholesales water.

Water Production Data

We collected from eight primary water wholesalers in the region data regarding monthly water production during the historical portion of the study period. This includes Canby, Clackamas, the Joint Water Commission, Lake Oswego, Portland, Oak Lodge, South Fork, and Tualatin Valley.

Weather Data

Historical daily weather data for January 1960 to December 1992 was collected from the City of Portland Water Bureau's subscription to the National Climatic Data Center historical series on CD-ROM. Historical weather was compiled for two separate weather stations in the Portland region, including the Portland Airport and the North Willamette Experimental Weather Station (hereby abbreviated NWES, located in Clackamas County). These stations collected separate streams of weather information, including minimum temperature, maximum temperature, precipitation, and snowfall. The NWES weather data also included evapotranspiration, which was collected for potential use in the demand forecast equations (but was not subsequently included).

We calculated the mean daily temperature as the average of minimum and maximum daily temperature. We also calculated the 32-year arithmetic means of daily temperature and precipitation for each month (i.e., the average daily temperature and precipitation for all January months, the average for all February months, etc.). These represent the long-term monthly averages. We then calculated the average temperature and precipitation for each month and year from 1983 to 1992. These represented the actual monthly averages for the historical portion of the water demand forecast. We subtracted the long-term average temperature and precipitation from the actual averages to calculate the actual monthly difference from the long-term average.

We performed a statistical test of the equality of the long-term monthly means of daily minimum and maximum temperature and daily precipitation between the two weather stations (statisticians refer to this as a "t-test"). We were interested to see if there was a statistically significant difference between the monthly mean weather statistics. This would start to indicate any long-run variation in the weather across the region. We found no statistically significant differences in the means of any of the weather statistics except for minimum temperature (and these differences were fairly small, approximately on the order of one or two degrees). Despite the relatively small degree of these weather differences, we decided to retain both weather stations for use in the demand forecasts.

We applied the Portland Airport weather station data for all forecasts in Multnomah and Washington Counties, and the NWES weather station data for all forecasts in Clackamas County. Additionally, for a subsequent scenario analysis of water demand weather sensitivity, we calculated the standard deviation of daily temperature and precipitation about the mean for each month and year in the historical portion of the forecast period (i.e., January 1983 to June 1992). This permitted us to estimate the 95% confidence interval about the mean of daily temperature and pressure in a given month of the forecast period. This scenario analysis is described briefly in the section of this chapter describing forecasting results.

Economic Data

We collected estimates of historical (i.e., 1982 to 1992) and forecasted county-specific annual per capita income and monthly employment from the State of Oregon Bureau of Economic Analysis. We estimated monthly per capita income as a straight-line function between end-of-year annual estimates for the per capita income estimates. We also collected the Consumer Price Index (CPI) for All Urban Consumers in the Portland-Vancouver metropolitan statistical area (MSA) from the State of Oregon

Employment Division. We used the CPI to adjust the historical and forecasted income estimates into "real" dollars (using a base year period of 1982 to 1984).

Additionally, historical estimates of population (i.e., 1980 to 1992) were collected from the Portland State University's Center for Population Research and Census for each city in the three-county regional area.

Forecast Drivers

Long-term annual average growth rate estimates for population, households, and employment by county were initially collected from the Metro Planning Department's Base Case II Summary of its Regional Forecast, Allocation, and Transportation Model (dated June 28, 1993). These estimates were updated on August 8, 1994, with Metro's Preferred Alternative Scenario. The Metro data included:

- 1990 census data aggregated to match water districts for:
 - Population.
 - Occupied households by housing types (e.g., single-family, multifamily).
- Forecasts by 10-year increment through 2015, aggregated to match water districts for:
 - Population.
 - Occupied households by housing types (e.g., single-family, multifamily).
 - Employment broken down between retail and non-retail.
- Historical data from the 1980's aggregated to match water districts for:
 - Population.
 - Households by housing type.
 - Employment broken down between retail and non-retail.

Conservation Measure Data

Information on water consumption by various end use equipment types was primarily derived from the seminal 1984 Brown and Caldwell study for the U.S. Department of Health and Urban Development.

Peak Day Factors

Information on peak day factors was based on the Phase 1 forecast compiled by CH2M Hill. We additionally compiled a list of peak day weather adjustments, described in section 2.4 above. This weather adjustment was based on a combination of the weather response coefficients (estimated in the econometric models for sales per account) and estimates of extreme weather occurring in the peak month (estimated by the 95 percent confidence interval for deviations of precipitation and temperature from their long-run normal values for each provider's peak month). The peak month weather adjustment is defined as the ratio of peak month sales in a month with weather conditions at their 95 percent confidence interval to peak month sales in a month with normal weather.

These assumptions are included in the spreadsheet PEAKFACT.XLS included in the data library for this documentation.

Price Elasticities

Our primary source of water demand price elasticities was a recent literature survey of price elasticity estimates developed by Ben Dziegielewski, "Estimating Price Elasticity of Demand For Water: The Impact of Conservation Rate Structures," in *Rate Structures to Promote Conservation*, Proceedings of A Conference Organized by the Delaware River Basin Commission and the New York City Water Board, 1990, pp. 11-27.

Real Price Increases

Although we did not incorporate specific capital budget plans into the price response portion of this study, we did capture the effect of consumer response to rising prices for water in real dollars through a simulation process. The assumptions underlying this simulation are included in the spreadsheet PRICEIN2.XLS included in the data library for this documentation.

Appendix D
DESCRIPTION OF FLAVOR PROFILE ANALYSIS



CITY OF
PORTLAND, OREGON
BUREAU OF WATER WORKS

Mike Lindberg, Commissioner
Michael F. Rosenberger, Administrator
1120 S.W. 5th Avenue
Portland, Oregon 97204-1926
Information (503) 823-7404
Fax (503) 823-6133
TDD (503) 823-6868

Activity: FLAVOR PROFILE ANALYSIS (FPA)

Date: Tuesday, July 11, 1995

Location: Water Bureau Water Quality Laboratory,
1900 N Interstate (at Tillamook)
Control Center/Lab Conference Room

Time: 2:00 pm official panel convenes;
3:00 pm unofficial tasters convene

Participants:

Official flavor profile analysis panel
Unofficial taste testers: Mike Lindberg, Mike Rosenberger, Greg Nokes, et al
Observers: Lorna Stickel, Roberta Jortner
Panel Coordinators: Alberta Seierstad and Dick Thies WB Lab

Purpose:

Using a single sampling of existing drinking water supplies, we are asking the panel to explore the taste and odor characteristics of sources under consideration for future use in the Portland metropolitan region. The results will be used to better understand the potential influence of different treatment/disinfection regimes and different sources on taste and odor characteristics.

This particular session will be set up to observe potential differences in how taste and odor of these samples are perceived by trained and untrained tasters using a structured, non-biased (blind sample), industry-accepted analytical approach.

Relationship to Regional Plan

The water providers in the Portland metropolitan region, along with METRO, are examining different ways to meet growing future water demand. Each of the FPA samples come from *existing potable water systems that obtain water from sources that are being considered for future use in the Portland metropolitan region*. Each of these systems complies with federal and state drinking water standards.

The Regional Water Supply Plan project is examining key issues, opportunities and constraints associated with each of the sources, including water quality and treatability, cost, reliability, environmental impacts, and the potential for conservation (along with/compared to new supply sources.)

The FPA can demonstrate differences in how various drinking water sources taste and smell. Potential differences can come from aspects of raw water quality and from treatment. The samples collected for the FPA represent a host of different filtration and disinfection techniques currently and potentially being used in and around the region.

Important considerations for July 11 analysis:

- The FPA technique does not rank or rate these samples or sources. It identifies perceived tastes and odors and their intensities, using industry standardized techniques and descriptors. It identifies ranges rather than hierarchies of attributes.
- These samples are not fully representative of the sources under consideration in the Regional Supply Plan. Differences in sample intake location, treatment/disinfection processes, and current water quality conditions can result in significant differences in the taste and odor of treated water.
- Samples of the Columbia and Willamette were collected from treatment plants with significantly differently intake locations than the sites under consideration for our Regional Supply Plan. They also represent differences in treatment.
- These are single samples collected in the last 24 hours. Seasonal changes in source water quality can result in markedly different tastes and odors at different times of the year.
- The FPA panelists are trained in the standardized techniques and descriptors over several months and receive periodic refresher training. This allows panelists to become especially sensitive to tastes and odors.
- The FPA testing is conducted in an environment that minimizes extraneous taste and odor interferences. The method includes warming of samples to further improve the ability to detect subtle qualities.
- The FPA panelists can detect tastes and odors that go unnoticed by most consumers in typical settings.

How it works:

Principle: FPA uses a panel of four or more trained tasters to examine the sensory attributes of samples. Odor and flavor are evaluated by sniffing and tasting. Panelists identify individual components of odor and flavor in the order in which they are sensed, and assign intensities to each.

Samples are not "ranked" by this method or given any sort of overall subjective grade. FPA results for water samples cannot be used to form a list that ranks samples from best to worst any more than a taste test of different flavors of soft drinks can.

Cautions: Panelists cannot eat or drink at least 1/2 hour before the session. Perfume or cologne is not allowed. The session is held in an odor-free environment.

Training: Panelists receive extensive training weekly for six months. Panelists are screened to ensure their ability to taste and smell standard attributes. During training, panelists are calibrated using the taste and odor standards listed below.

Taste Standards: Taste standards cover the four basic tastes: sweet, sour, salt and bitter. The panel is trained with standards covering the entire intensity scale of 1 to 12. On this scale, 1 is at threshold (just detectable), 2 is very weak, 4 is weak, 6 is weak to moderate, 8 is moderate and 12 is strong. The sweet taste standard is used for estimating both taste and odor intensities as there are no sweet odor intensity standards.

Odor Standards: These are standards used to characterize different odor types. They generally consist of small amounts of selected chemicals spiked into odor-free water, although a few are prepared from other ingredients such as cloves, dried grass, wet grass, rubber hose and soap. The odor standards we use include:

COMPOUND	DESCRIPTOR
Benzaldehyde	Sweet almond
Chlorine (free)	Chlorine
Coumarin	Summer grass/vanilla
Cumene	Shoe polish
Diphenyl ether	Geranium
1-Dodecanol	Liquid dishwashing detergent
Eucalyptol	Vick's Vapo Rub
Geosmin	Earthy
Heptanal	Rancid walnut oil
1-Heptanone	Sweet banana

Hexanal
cis-3-Hexen-1-ol
d-Limonene
2-MIB
Methyl methacrylate
trans-2-Nonenal
Styrene
m-Xylene

Lettuce heart
Fresh grass
Citrus
Musty
Plastic
Cucumber
Model airplane glue
Sweet organic chemical

Cloves
Dried grass
Grass in water
Rubber hose
Soap
Wood shavings

Clove
Grassy
Decaying vegetation; septic
Rubber hose
Soap
Wood shaving

Procedure:

- 1) Place the sample cup before you at the edge of the table.
- 2) While keeping the cover on the cup, gently swirl cup briefly to help release odors from the sample.
- 3) Slide the cover to the side, and sniff the sample. Keep hands away from the cup and your face while sniffing.
- 4) Note any odors detected and their intensities on your worksheet.
- 5) Take a small taste of the sample. Sipping, slurping and swishing the sample in your mouth is encouraged. (All samples are potable so it is okay to swallow.)
- 6) Note down all tastes detected and their intensities on the worksheet.
- 7) After pausing for one minute, note all aftertastes, if any, and their intensities on the worksheet.
- 8) Cleanse palate with taste-and-odor-free water and proceed with the next sample.

Taste descriptors:

Sweet, Sour, Salty and Bitter. Mouthfeel (astringent, burning/peppery, carbonated, chalky, cooling, metallic, slippery/slimy, warm.)

Many odor descriptors are also used for taste descriptors because the sense of smell is closely tied to tasting. Chlorine might technically only produce an astringent taste effect in the mouth, but it is smelled while tasting. A "chlorine taste" is inevitably reported. Since our customers taste our water this way, our FPA panel does likewise.

Odor descriptors:

Alcohol	Grassy	Potato bin	Vegetation
Algae	Hay	Refinery	Wet Paper
Almond, sweet	Hydrocarbon	Rubber	Woody
Antiseptic	Iodine	Seaweed	
Barnyard	Manure	Septic	
Bitter	Marshy	Sewage	
Bleach	Medicinal	Shoe polish	
Camphor	Melon	Skunk	
Chalky	Metallic	Slimy	
Chemical	Mineral	Smokey	
Chlorine	Moldy	Soapy	
Creeky	Musty	Solvent	
Cucumber	Onion	Sour	
Earthy	Orange peel	Spicy	
Fish tank	Paper	Stale	
Fishy	Peppers	Sulfur	
Flowery	Phenol	Swampy	
Fresh	Pigpen	Sweet	
Fruity	Pipey	Swimming pool	
Garlic	Plastic	Varnish	

How we calculate FPA Panel results:

After all samples are completed, each panelist provides their odor descriptors and intensities for each sample. The odor descriptors and intensities are tabulated. This is repeated for the tastes and aftertastes. If the panel coordinator sees different descriptors from different panelists that *may* represent the same odor or taste, a group discussion will be initiated to see if a single descriptor can be found that will be satisfactory to all panelists involved.

The panel coordinator takes the tabulated data and for each descriptor determines if 50% or more of the panel reported it. If less than 50% reported it, that descriptor is considered a "note." It is reported as being detected, but has no

intensity value. If 50% or more of the panel reports a descriptor, that descriptor is reported as an official descriptor, together with its "average" intensity value.

The average intensity value is calculated by adding the numerical values of the intensities reported and dividing by the total number of panelists (not just by the number of panelists who reported the descriptor.)

FLAVOR PROFILE SURVEY

PROCEDURE

NOTE: While you are surveying samples, avoid talking, and keep your comments to yourselves.

For each sample:

1. Place the sample cup before you at the edge of the table.
2. While keeping the cover on the cup, gently swirl the cup briefly to help release odors from the sample.
3. Slide the cover off to the side, and sniff the sample. Keep your hands away from the cup and your face while sniffing.
4. Note any odors detected and their intensities on the worksheet (see descriptors and intensity scale below).
5. Now take a small taste of the sample. Sipping, slurping and swishing the sample in your mouth are encouraged.
Note: All of the samples are potable, so it's O.K. to swallow the sample.
6. Note all tastes detected and their intensities on the worksheet (see descriptors and intensity scale below).
7. After pausing for about one minute, note all aftertastes, if any, and their intensities on the worksheet (see descriptors and intensity scale below).
8. Cleanse your palate with the taste-and-odor-free water, and proceed with the next sample.

Only after panel members and observers have finished all samples, will the identity of the samples be revealed.

SOME COMMON TASTE AND ODOR DESCRIPTORS:

Algae	Chalky	Fishy	Medicinal	Papery	Swampy
Antiseptic	Chlorine	Fruity	Metallic	Salty	Sweet
Astringent	Drying	Grassy	Mineral	Sour	Vegetation
Bitter	Earthy	Marshy	Moldy/musty	Stale	Woody

ODOR INTENSITY SCALE:

Intensities are recorded on a scale of 1 to 12

1 = just detectable 2 = very weak 4 = weak 6 = weak to moderate 8 = moderate 12 = strong

Portland Water Bureau, Water Quality Laboratory
 July 11, 1995 Flavor Profile Analysis Data Report for the Regional Water Supply Plan, page 1

Sample Identity	Odor Descriptor	Odor Intensity	Taste Descriptor	Taste Intensity	Aftertaste Descriptor	Aftertaste Intensity	Notes
City of Corvallis, bench-treated with GAC	Chlorine	1	Chlorine	1	Bitter	1	Odor: stale, sweet Taste: antiseptic Aftertaste: antiseptic, drying
			Mineral	1			
South Fork Water Board							Odor: chlorine, earthy, fresh, stale Taste: coating, fresh, grassy, mineral Aftertaste: coating, salty
City of Portland, adjustment to pH 7.5 with sodium hydroxide	Chlorine (swimming pool)	1	Bitter	1			Odor: geranium Taste: antiseptic Aftertaste: antiseptic, bitter, salty
	Musty	1	Chlorine	1			
City of Corvallis	Chlorine	3	Chlorine	2			Odor: chemical, grassy Taste: bitter, chemical, salty Aftertaste: bitter, coating
	Musty	2	Stale/Musty	2			
City of Portland	Chlorine	1					Taste: coating Aftertaste: bitter
	Musty/Stale	1					
Clackamas Water District	Chlorine	1	Chlorine	1			Odor: musty Taste: coating, earthy, mineral, musty Aftertaste: drying, metallic
	Earthy	1					
City of Kennewick	Chlorine (swimming pool)	2	Chlorine	2	Drying	1	Odor: stale Taste: mineral
			Musty	1			
Joint Water Commission	Chlorine	1	Bitter	1	Bitter	1	Odor: stale Taste: sweet
			Chlorine	1			
			Mineral	1			
			Papery	1			

Alberte Sienstad

Laboratory Supervisor

Portland Water Bureau, Water Quality Laboratory
July 11, 1995 Flavor Profile Analysis
for the Regional Water Supply Plan
page 2

SAMPLE INFORMATION

▶ Sample Identity:	▶ City of Corvallis, bench-treated with GAC
Date/Time Collected:	July 10, 1995, 1:30 p.m.
Sample Location:	Water Treatment Plant Lab
Collected by:	Dan Scottie
Bench-treated/By:	July 11, 1995, Thies
Date Analyzed:	July 11, 1995
Analyzed by:	Gilbey, Hyde, Sheets and Thies

▶ Sample Identity:	▶ South Fork Water Board
Date/Time Collected:	July 11, 1995, 9:05 a.m.
Sample Location:	Treatment Plant, Clearwell Effluent
Collected by:	Larry Sparling
Date Analyzed:	July 11, 1995
Analyzed by:	Gilbey, Hyde, Sheets and Thies

▶ Sample Identity:	▶ City of Portland, adjustment to pH 7.5 with sodium hydroxide
Date/Time Collected:	July 11, 1995, 9:45 a.m.
Sample Location:	Powell Butte
Collected by:	Bill Hyde
Bench Treated/By:	July 11, 1995, Thies
Date Analyzed:	July 11, 1995
Analyzed by:	Gilbey, Hyde, Sheets and Thies

▶ Sample Identity:	▶ City of Corvallis
Date/Time Collected:	July 10, 1995, 1:30 p.m.
Sample Location:	Water Treatment Plant Lab
Collected by:	Dan Scottie
Date Analyzed:	July 11, 1995
Analyzed by:	Gilbey, Hyde, Sheets and Thies

▶ Sample Identity:	▶ City of Portland
Date/Time Collected:	July 11, 1995, 9:45 a.m.
Sample Location:	Powell Butte
Collected by:	Bill Hyde
Date Analyzed:	July 11, 1995
Analyzed by:	Gilbey, Hyde, Sheets and Thies

▶ Sample Identity:	▶ Clackamas Water District
Date/Time Collected:	July 11, 1995, 10:40 a.m.
Sample Location:	Water Treatment Plant
Collected by:	Mike Sheets
Date Analyzed:	July 11, 1995
Analyzed by:	Gilbey, Hyde, Sheets and Thies

▶ Sample Identity:	▶ City of Kennewick
Date/Time Collected:	July 10, 1995, 1:00 p.m.
Sample Location:	Water Treatment Plant
Collected by:	Jim Cooke
Date Analyzed:	July 11, 1995
Analyzed by:	Gilbey, Hyde, Sheets and Thies

▶ Sample Identity:	▶ Joint Water Commission
Date/Time Collected:	July 11, 1995, 9:00 a.m.
Sample Location:	Water Treatment Plant Lab
Collected by:	Art Woll
Date Analyzed:	July 11, 1995
Analyzed by:	Gilbey, Hyde, Sheets and Thies

Laboratory Supervisor

Alberta Suiestad

**Flavor Profile Analysis (FPA) for Water Sources Under
Consideration for Future Use in the
Portland Metropolitan Region**

Regional Water Supply Plan Source Option Information

Source Options	Representative Intake Location - River Mile (RM)	Recommended* Future Treatment / Disinfection Methods
Bull Run River (unfiltered)	Headworks on the Bull Run River, Mt. Hood National Forest. RM 6.2	Current approach: Unfiltered with chlorine/chloramine disinfection (and pH adjustment as necessary).
Bull Run River** (filtered)	Headworks on the Bull Run River, Mt. Hood National Forest. RM 6.2	Ozonation for disinfection and oxidation. Granular activated carbon (GAC) filtration.
Clackamas River	Between @ RM 1 to RM 3.3 (Intake sites include existing facilities operated by Lake Oswego, Clackamas River Water, South Fork Water Board, and Oak Lodge Water District.)	Conventional treatment (including sedimentation), GAC filtration, and pre-chlorination or post-chlorination for disinfection.
Columbia River	Approximately one mile downstream of the Columbia/Sandy River confluence (Oregon side) @RM 119 (approx).	Ozonation for disinfection and oxidation. Granular activated carbon (GAC) filtration.
Trask/Tualatin Rivers	RM 56.1	Conventional filtration, alum coagulant, pre and post disinfect with chlorine, non-ionic polymer as filter aid, pH adjustment with soda ash, activated carbon as needed for taste and odor.
Willamette River	Approximately 3700 feet upstream of the I-5 Bridge at Wilsonville; @RM 39 (approx)	Ozonation for disinfection and oxidation. Granular activated carbon (GAC) filtration.

* The "recommended future treatment/disinfection methods" are presented in the Regional Water Supply Plan *Source Options Analysis Element - Task 7 Final Interim Report - Water Treatment Analysis* (Montgomery Watson, May 1994).

** The Regional Water Supply Plan project considers the possibility that the Bull Run source may at some future time need to be filtered to may increasingly stringent drinking water regulations. The recommended approach cited here emanates from the findings of the *Water Treatment Pilot Study* (Montgomery Watson, April 1992) as referenced in the *Regional Water Supply Plan Source Options Analysis Element - Task 7 Final Interim Report - Water Treatment Analysis* (Montgomery Watson, May 1994).

**Flavor Profile Analysis (FPA) for Water Sources Under
Consideration for Future Use in the
Portland Metropolitan Region**

FPA Water Sample Information

Source of FPA Drinking Water Samples	Water Provider Agency	Sample Intake Location - River Mile (RM)	Sample Treatment/Disinfection Methods
Bull Run River	City of Portland	Headworks on the Bull Run River, Mt. Hood National Forest. RM 6.2	Unfiltered with chlorine/chloramine disinfection.
Bull Run River*	City of Portland	Headworks on the Bull Run River, Mt. Hood National Forest. RM 6.2	Same as above, plus pH adjustment to 7.5 using sodium hydroxide (see footnote).
Clackamas River	Clackamas Water District	RM 3.3	Pre-chlorinate, conventional filtration with coagulate w/alum, polymer as filter aid, post chlorinate. May use activated carbon on that day.
Clackamas River	South Fork Water District (cities of Oregon City and West Linn)	RM 1.7	Prechlorination, alum coagulant, flocculation, polymeric (Praestol 2515TR) aid, filter beds of anthracite, silica, garnet, and gravel. Chlorine and sodium carbonate added to 7.2-7.5.
Columbia River	City of Kennewick, WA	City of Kennewick Water Filtration Treatment Plant. @RM 328.	Dual media (anthracite over sand), direct filtration. Ozone as primary disinfectant. Chlorine added at finish water clearwell. Ferric Chloride primary coagulant w/ Caffloc-T coagulant aid. Caustic soda for pH adjustment.
Trask/Tualatin Rivers (treatment plant located on Tualatin River)	Joint Water Commission (cities of Hillsboro, Beaverton, and Forest Grove)	RM 56.1	Conventional filtration using, alum coagulant, pre and post disinfection with chlorine, non-ionic polymer as filter aid, pH adjustment with soda ash.
Willamette River	City of Corvallis	RM 134	Conventional filtration using alum coagulant and pH adjustment using lime. Chlorine added for disinfection. Fluoride added.
Willamette River**	City of Corvallis	RM 134	Same as above but treated on a bench scale with GAC media (see footnote).

* Sample is pH adjusted to simulate corrosion control treatment that may be implemented to comply with Safe Drinking Water Act Lead and Cooper Rule, and to indicate the taste effects of this treatment approach.

** Sample has been filtered using granular activated carbon (GAC) media to simulate anticipated treatment upgrade planned by the City of Corvallis, and to indicate the taste effect of this treatment approach.

Appendix E
CONSERVATION MEASURE SCREENING RESULTS

APPENDIX E: CONSERVATION MEASURE SCREENING RESULTS

**TABLE E-1
SCREENING RESULTS FOR INDOOR MEASURES**

End Use	Candidate Measure	Pass Qual Screen?	Pass Econ Screen?	Description	
PASSED BOTH SCREENS					
RESIDENTIAL					
Residential Shower (Assume SF household with 2.8 occupants/household. b/c ratios are sufficiently high that it is clear the measures will also pass for multifamily.)	Ultra low-flow Showerheads: 1.3 gpm (comparison at average retail price)	YES	YES	Early retirement of s.h. w/ 3.4 gpm observed flow	
		YES	YES	Early retirement of s.h. w/ 2.6 gpm observed flow	
		YES	YES	Early retirement of s.h. w/ 1.7 gpm observed flow	
		YES	YES	Compare installation of new 1.3 gpm vs. 1.7 gpm	
	Ultra low-flow showerheads (Comparison at wholesale price, defined as price to utilities for large-scale programs)	YES	YES	Early retirement of s.h. w/ 3.4 gpm observed flow	
		YES	YES	Early retirement of s.h. w/ 2.6 gpm observed flow	
		YES	YES	Compare installation of new 1.3 gpm vs. 1.7 gpm	
		YES	YES	Early retirement of s.h. w/ 3.4 gpm observed flow	
	Low-flow showerheads: 2.5 gpm (retail price)	YES	YES	Early retirement of s.h. w/ 2.6 gpm observed flow	
		YES	YES	Early retirement of s.h. w/ 3.4 gpm observed flow	
		YES	YES	Early retirement of s.h. w/ 2.6 gpm observed flow	
		YES	YES	Early retirement of s.h. w/ 3.4 gpm observed flow	
Low-flow showerheads (wholesale price)	YES	YES	Early retirement of s.h. w/ 3.4 gpm observed flow		
	YES	YES	Early retirement of s.h. w/ 2.6 gpm observed flow		
	YES	YES	Early retirement of s.h. w/ 3.4 gpm observed flow		
	YES	YES	Early retirement of s.h. w/ 2.6 gpm observed flow		
Faucet aerators	Low-flow faucet aerators (retail price)	YES	YES	Install aerator on 3.3 gpm faucet w/o	
	Low-flow faucet aerators (wholesale price)	YES	YES	Install aerator on 3.3 gpm faucet w/o	
	Low-flow faucet aerators (retail price)	YES	YES	Install aerator on 2.0 gpm faucet w/o	
	Low-flow faucet aerators (wholesale price)	YES	YES	Install aerator on 2.0 gpm faucet w/o	
Leaking Faucet	Install new seat, washer, cartridge	YES	YES	Install to correct 1/2 inch drip or bigger	
GRAVITY FLOW ULF Toilets (single family) (Assume 2 toilets per hh; cost incl. 2 hrs labor @ \$40/hr)	ULFT gravity-flow tank type (1.6 GPF) (Comparison at retail price)	YES	YES	Early retirement of 3.5 GPF toilet - 1 toilet repl.	
		YES	YES	Early retirement of 5.5 GPF toilet - 1 toilet repl.	
		YES	YES	Early retirement of 3.5 GPF toilet - 2 toilet repl.	
		YES	YES	Early retirement of 5.5 GPF toilet - 2 toilet repl.	
	ULFT gravity-flow tank type (1.6 GPF) (Comparison at wholesale price)	YES	YES	Early retirement of 3.5 GPF toilet - 1 toilet repl.	
		YES	YES	Early retirement of 5.5 GPF toilet - 1 toilet repl.	
		YES	YES	Early retirement of 3.5 GPF toilet - 2 toilet repl.	
		YES	YES	Early retirement of 5.5 GPF toilet - 2 toilet repl.	
	ULF Toilets (multifamily) (Assume 1.5 toilets per hh; cost incl. 2 hrs. labor @ \$40/hr)	ULFT gravity-flow tank type (1.6 GPF) (Comparison at retail price)	YES	YES	Early retirement of 3.5 GPF toilet - 1 toilet repl.
			YES	YES	Early retirement of 5.5 GPF toilet - 1 toilet repl.
			YES	YES	Early retirement of 3.5 GPF toilet - 1.5 toilet repl.
			YES	YES	Early retirement of 5.5 GPF toilet - 1.5 toilet repl.
ULFT gravity-flow tank type (1.6 GPF) (Comparison at wholesale price)		YES	YES	Early retirement of 3.5 GPF toilet - 1 toilet repl.	
		YES	YES	Early retirement of 5.5 GPF toilet - 1 toilet repl.	
		YES	YES	Early retirement of 3.5 GPF toilet - 1.5 toilet repl.	
		YES	YES	Early retirement of 5.5 GPF toilet - 1.5 toilet repl.	
PRESSURIZED TANK ULF Toilets (single family) (Assume 2 toilets per household; costs incl. 2 hrs labor @ \$40/hr.)	ULFT pressurized (compare at retail price)	YES	YES	Early retirement of 5.5 GPF toilet - 1 toilet repl.	
		YES	YES	Early retirement of 3.5 GPF toilet - 1 toilet repl.	
		YES	YES	Early retirement of 5.5 GPF toilet - 1 toilet repl.	
		YES	YES	Early retirement of 3.5 GPF toilet - 2 toilet repl.	
	ULFT Toilets (multifamily) (Assume 1.5 toilets per hh; cost incl. 2 hrs. labor @ \$40/hr)	ULFT pressurized tank type (1.6 GPF) (Comparison at retail price)	YES	YES	Early retirement of 3.5 GPF toilet - 1 toilet repl.
			YES	YES	Early retirement of 5.5 GPF toilet - 1 toilet repl.
			YES	YES	Early retirement of 3.5 GPF toilet - 1.5 toilet repl.
			YES	YES	Early retirement of 5.5 GPF toilet - 1.5 toilet repl.
		ULFT pressurized tank type (1.6 GPF) (Comparison at wholesale price)	YES	YES	Early retirement of 3.5 GPF toilet - 1 toilet repl.
			YES	YES	Early retirement of 5.5 GPF toilet - 1 toilet repl.
			YES	YES	Early retirement of 3.5 GPF toilet - 1.5 toilet repl.
			YES	YES	Early retirement of 5.5 GPF toilet - 1.5 toilet repl.
Toilet Tank Devices (Screened for MF; includes affect of chloramines as shown: screened for multifamily assumes both toilets retrofitted)	Displacement bags (without chloramines)	YES	YES	Install bag in 3.5 or 5.5 GPF toilet	
	Displacement bags (with chloramines)	YES	YES	Install bag in 3.5 or 5.5 GPF toilet	
	Fill-cycle regulators (without chloramines)	YES	YES	Install regulator in 3.5 or 5.5 GPF toilet	
	Fill-cycle regulators (with chloramines)	YES	YES	Install regulator in 3.5 or 5.5 GPF toilet	
Toilet Leak Detection	Early closure flapper valve (w/o chloramines)	YES	YES	Install flapper in 3.5 or 5.5 GPF toilet	
	(Assumes 1 hr. labor @ \$40/hr)	YES	YES	Average expected losses from leaking toilet	
Horizontal Axis Clothes Washer	SF Residential (incl. 1/2 hr labor @ \$40/hr)	YES	NOH	Purchase of new horiz instead of new vertical	
Horizontal Axis Clothes Washer (Incl. 1/2 hr. labor @ \$40/hr.)	MF Residential (incl. 1/2 hr labor @ \$40/hr)	YES	YES	Early retirement of high-volume vertical axis	
		YES	YES	Purchase of new horiz instead of new vertical	
Residential Dishwashers	Lower volume/optional cycle dishwashers	YES	YES	Purchase new low volume instead of medium vol	

TABLE E-1 (Continued)

End Use	Candidate Measure	Pass Qual Screen?	Pass Econ Screen?	Description	
CI&I					
Commercial Toilets (Assume 2 hrs labor @ \$40/hr)	ULF valve-type toilet (1.6 GPF) (comparison at retail price)	YES	YES	Early retirement of 4.5 GPF valve-type toilet	
		YES	YES	Early retirement of 3.5 GPF valve-type toilet	
		YES	YES	Purchase new 1.6 GPF instead of 3.5 GPF	
	ULF valve-type toilet (1.6 GPF) (comparison at wholesale price)	YES	YES	Early retirement of 4.5 GPF valve-type toilet	
		YES	YES	Early retirement of 3.5 GPF valve-type toilet	
		YES	YES	Purchase new 1.6 GPF instead of 3.5 GPF	
	ULFT tank-type toilet (1.6 GPF) (comparison at retail price)	YES	YES	Early retirement of 5.5 GPF tank-type toilet	
		YES	YES	Early retirement of 3.5 GPF tank-type toilet	
	ULFT tank-type toilet (1.6 GPF) (comparison at wholesale price)	YES	YES	Early retirement of 5.5 GPF tank-type toilet	
		YES	YES	Early retirement of 3.5 GPF tank-type toilet	
	ULFT pressurized tank-type (1.6 GPF) (comparison at retail price)	YES	YES	Early retirement of 5.5 GPF tank-type toilet	
		YES	YES	Early retirement of 3.5 GPF tank-type toilet	
	ULFT pressurized tank-type (1.6 GPF) (comparison at wholesale price)	YES	YES	Early retirement of 5.5 GPF tank-type toilet	
		YES	YES	Early retirement of 3.5 GPF tank-type toilet	
Valve retro (incl. 0.5 hr @ \$40/hr)	YES	YES	Retrofit 4.5 GPF to 3.5 GPF		
Urinals	Valve retro (incl. 0.5 hr @ \$40/hr)	YES	YES	Retrofit 1.5 GPF to 1.0 GPF	
Commercial faucets	Manual low-flow faucet	YES	YES	Early retirement of 2.0 gpm faucet	
	Same	YES	YES	Early retirement of 3.3 gpm faucet	
	Pressure closing faucet	YES	YES	Early retirement of 2.0 gpm faucet	
	Same	YES	YES	Early retirement of 3.3 gpm faucet	
	Same	YES	YES	Purchase pressure closing instead of standard manual	
	Foot-pedal operated faucet	YES	YES	Early retirement of 2.0 gpm faucet	
	Same	YES	YES	Early retirement of 3.3 gpm faucet	
	Same	YES	YES	Purchase foot-pedal instead of standard manual	
	Infrared activated	YES	YES	Early retirement of 2.0 gpm faucet	
	Same	YES	YES	Early retirement of 3.3 gpm faucet	
	Ultrasonic activated faucet	YES	YES	Early retirement of 2.0 gpm faucet	
	Same	YES	YES	Early retirement of 3.3 gpm faucet	
	Ultrasonic device only (wholesale price)	YES	YES	Install on 2.0 gpm faucet	
	Same	YES	YES	Install on 3.3 gpm faucet	
	Ultrasonic device only (retail price)	YES	YES	Install on 2.0 gpm faucet	
	Same	YES	YES	Install on 2.0 gpm faucet	
	Spring-loaded faucet (w/aerator)	YES	YES	Early retirement of 2.0 gpm faucet	
	Same	YES	YES	Early retirement of 3.3 gpm faucet	
	Commercial Clothes Washing	Coin-operated front-loading machine	YES	YES	Purchase front-loading instead of average vertical
		Eff. machines for commercial applications [3]	YES	N/A	Application is site-specific. Include in commercial audit.
Comm. dishwashing (restaur/instit)	Purchase recycling instead of standard new	YES	YES	Purchase recycling instead of standard new	
Commercial HVAC measures [4] (O&M costs have been factored in and discounted to the NPV at a discount rate of 6%)	Purchase new air-cooled unitary system	YES	YES	Purchase new water-cooled unitary system	
	Purchase new air-cooled chiller	YES	YES	Purchase new water-cooled chiller	
	Purchase new air-cooled A/C	YES	YES	Purchase single-pass condenser A/C Cooling	
	Purch. closed-loop cond. A/C Cooling	YES	YES	Purchase single-pass condenser A/C Cooling	
	Early retire. of single pass/install closed	YES	YES	Base Comparison #1 (see tech profile for description)	
	Early retire. of single pass/install closed	YES	YES	Base Comparison #2 (see tech profile for description)	
	Impr. O&M practices of water-cooled conden.	YES	YES	Continue with poor O&M practices	
	Ozonation of cooling tower water	YES	YES	Good O&M practices	
	Improve O&M practices of evap coolers	YES	N/A	Combined with O&M for water-cooled condensers	
	Steam condensate return system heat exch.	YES	N/A	Data not available to characterize measure potential.	
	Air-cooled pumps and compressors	YES	N/A	Data not available to characterize measure potential.	
Commercial Miscellaneous	Air-cooled ice-makers	YES	YES	Water cooled, per 100 lb ice	
	Air-cooled drinking fountains (16 gal/hr.)	YES	YES	Average installed water-cooled drinking fountains	
	Individual dwelling unit submeters	YES	YES	Compare to master-metered	
Industrial Miscellaneous (Some commercial application as well)	HVAC measures (see above)	YES	N/A	Must be evaluated on a site-specific basis	
	Improve industrial washers and rinsers	YES	N/A	Must be evaluated on a site-specific basis	
	Install solenoid and automatic control valves	YES	N/A	Must be evaluated on a site-specific basis	
	Eval. water recycling	YES	N/A	Must be evaluated on a site-specific basis	
	Eval. waste stream separation	YES	N/A	Must be evaluated on a site-specific basis	
	Install sub-meters for irrigation	YES	N/A	Must be evaluated on a site-specific basis	
Leak detection	Ultra-sonic leak detection; leak repair	YES	N/A	Must be evaluated on an agency-specific basis	

NEED FURTHER RESEARCH

ULF Toilets	ULFT special < 1 gallon flush	NO	N/A	Technological/market maturity
-------------	-------------------------------	----	-----	-------------------------------

TABLE E-1 (Continued)

End Use	Candidate Measure	Pass Qual Screen?	Pass Econ Screen?	Description
FAILED ECONOMIC SCREEN				
RESIDENTIAL				
PRESSURIZED TANK ULF toilets (single family) (Assume 2 toilets per hh; costs incl. 2 hrs labor @ \$40/hr)	ULFT pressurized tank type (1.6 GPF) (Comparison @ retail price)	YES	NO	Early retirement of 3.5 GPF toilet - 1 toilet repl.
		YES	NO	Early retirement of 3.5 GPF toilet - 2 toilet repl.
	(Comparison @ wholesale price)	YES	NO	Early retirement of 5.5 GPF toilet - 2 toilet repl.
PRESSURIZED TANK - MF Res.	(Comparison @ retail price)	YES	NO	Early retirement of 3.5 GPF toilet - 1.5 toilet repl.
Toilet Tank Devices (screened for MF; assumes both toilets are retrofitted)	Dual-flush devices (without chloramines)	YES	NO	Install adapter in 3.5 or 5.5 GPF toilet
	Dual-flush devices (with chloramines)	YES	NO	Install adapter in 3.5 GPF toilet
	Early closure flapper valve (with chloramines)	YES	NO	Install flapper in 3.5 or 5.5 GPF toilet
Residential Clothes Washers SF Residential (Incl. 1/2 hr. labor @ \$40/hr.)	Lower volume/optional cycle vertical axis	YES	NO	Early retirement of high-volume vertical axis
	Horizontal axis washing machines	YES	NO	Early retirement of high-volume vertical axis
Residential Clothes Washers MF Res (17 resid/machine)	Lower volume/optional cycle vertical axis	YES	NO	Early retirement of low volume vertical axis
		YES	NO	Early retirement of high-volume vertical axis
Residential Dishwashers	Lower volume/optional cycle dishwashers	YES	NO	Early retirement of high volume machine
		YES	NO	Early retirement of medium volume machine
C&I				
Urinals (Assume 3 hrs labor @ \$40/hr)	ULF urinals (comparison at retail price)	YES	NO	Early retirement of 1.5 GPF
	ULF urinals (comparison at wholesale price)	YES	NO	Early retirement of 1.5 GPF
Commercial faucets	Infrared activated faucet	YES	NO	Purchase infrared instead of standard manual
	Ultrasonic activated faucet	YES	NO	Purchase ultrasonic activated instead of manual
	Spring-loaded faucet (w/o aerator)	YES	NO	Purchase spring-loaded instead of standard manual
Commercial Clothes Washing	Coin-operated front-loading machine	YES	NO	Early retirement of average vertical axis
Commercial Dish Washing (Restaurants and institutions)	Water-efficient dishwashers	YES	NO	Early retirement of 6.0 gal per load
	Water recycling dishwasher	YES	NO	Early retirement of 6.0 gal per load
Commercial Misc.	Swimming pool covers	YES	NO	Install summer solar cover on 40x80 ft. pool
FAILED QUALITATIVE SCREEN				
RESIDENTIAL				
Residential shower	Shower-flow restrictors	NO	N/A	Low-flow showerheads are a better measure.
Toilet Retrofit Devices	Toilet displacement bottles	NO	N/A	Dams too bulky for delivery; bags a better measure.
	Toilet displacement dams	NO	N/A	Displacement bags are a better measure
Residential Misc.	Repl. self-gener. water softeners	NO	N/A	Water in region already soft.
	Point-of-use water heaters	NO	N/A	Limited capacity; not adequate for multiple uses.
	Recirculating hot water system dev	NO	N/A	Waste energy; redundant with current practices.
	Individual dwelling unit submeters	NO	N/A	Better measure available; poor utility match.
	Separate irrigation submeters	NO	N/A	Better measure available; poor utility match.
	Metering all accounts	NO	N/A	All participating water providers have implemented.
	Water pressure regulator	NO	N/A	Average pressure in region is less than 80 psi.
C&I				
Commercial Toilet	Infrared activated flushing	NO	N/A	Does not save water; implemented for sanitary reasons
Commercial Misc.	Point-of-use water heaters	NO	N/A	Limited capacity; not adequate for multiple uses.
	Recirculating hot water system dev	NO	N/A	Waste energy; redundant with current practices.
	Water softeners - centralized regeneration	NO	N/A	Water in region already soft.
	Water softeners - meter-controlled flushing	NO	N/A	Water in region already soft.
Commercial Washers	Ozonated washers	NO	N/A	Few eligible customers in the Portland region.
Air-cooled machinery	Medical and laboratory equipment	NO	N/A	Overall water use of this end-use is low.
Food handling	Chemical sanitizer dishwashers	NO	N/A	Potential problems due to bleach handling.
	Conveyor belt dishwashers	NO	N/A	Not interchangeable with door-type; capacities differ.
	Ultra-sound dishwashers	NO	N/A	Not been adequately tested for commercial application.
	Warming tables with dry heat	NO	N/A	Water waste due to evaporation is minimal.
	Garbage disposers using recycled water	NO	N/A	Poor customer acceptance; perceived higher labor cost.
Industrial misc.	Off-site garbage disposal	NO	N/A	Poor customer acceptance; perceived higher labor cost.
	On-site water reclamation/treatment	NO	N/A	Limited applicability

[1] If analysis on energy savings conducted by the Washington State Energy Office is included, horizontal axis washers pass the screen.

[2] We assume that both the seat and the cartridge are replaced with an added labor cost of one hour @ \$40 per hour. We assume the leak is 54 gallons per month. The measure passes under these assumptions and would therefore pass if the leak were more extensive and/or the work was done by the homeowner.

**TABLE E-2
SCREENING RESULTS FOR OUTDOOR MEASURES**

End Use	Pass Qual Scrn?	Pass *Econ Scrn?	Candidate Measure	Description
---------	-----------------	------------------	-------------------	-------------

PASSED BOTH SCREENS				
Drip System vs. Sprinkler System	YES	YES	Mtls. & labor (\$2,883 spr. vs \$2,646 drip)	1,250 sq.ft. plantings/1,250 sq. ft. turf
INCREMENTAL COST	YES	YES	Mtls. & labor (\$4,317 spr. vs \$4,168 drip)	2,500 sq.ft. plantings/2,500 sq.ft. turf
Improvements to Existing Automatic Sprinkler System	YES	YES	Timers	Incremental improvement over current practices
			Controllers	Incremental improvement over current practices
Rainsensors	YES	YES	Mtls. only	2,500 sq.ft. landscaped area
(Install with automatic sprinkler; assumed to be hard-wired to controller)	YES	YES	Mtls. & Labor	Same
	YES	YES	Mtls. only	5,000 sq.ft. landscaped area
	YES	YES	Mtls. & Labor	Same
Water effic. landscping vs. non-eff all sprinkler/unlandscaped	YES	YES	Mtls. only	50/50 vs. 20/80 turf to plant ratio (2,500 sq.ft.)
INCREMENTAL COST	YES	YES	Mtls. & labor	Same
	YES	YES	Mtls. only	50/50 vs. 20/80 turf to plant ratio (5,000 sq.ft.)
	YES	YES	Mtls. & labor	Same
Eff. plants vs. non-eff. INCR. all sprinkler/unlandscaped	YES	YES	Mtls. & labor (costs for efficient and non- <i>effic.</i> plants are the same)	1,250 sq.ft. of plants
	YES	YES		2,500 sq.ft. of plants
Eff. plants vs. non-eff. INCR. drip system/unlandscaped	YES	YES	Mtls. & labor (costs for efficient and non- <i>effic.</i> plants are the same)	1,250 sq.ft. of plants
	YES	YES		2,500 sq.ft. of plants
Turf replacement 50/50 to 20/80 at FULL COST	YES	YES	Mtls. only (Note: no labor costs included)	750 sq.ft. turf relandscaped to plants
	YES	YES	Mtls. only (Note: no labor costs included)	1,500 square ft. turf relandscaped to plants
Irrigation scheduling	YES	YES	Educational materials only	Any landscape size
Shut-off Devices	YES	YES	Hose control nozzles	Standard 2,500 sq.ft. lot
FULL COST	YES	YES	Garden hose timers	Average SF landscape irrig. system w/o timer
Convert quick coupler	YES	YES	Mtls. only (Note: no labor costs included)	Two acres of turf
FULL COST	YES	YES	Mtls. only (Note: no labor costs included)	Five acres of turf

NEED FURTHER RESEARCH				
Computerized weather station	YES	YES	Minimum savings per site to pass	One site hookup
	YES	YES	Case Study: Aurora Colorado	One site hookup
	YES	YES	Case Study: Vancouver, WA	One site hookup
Subsurface turf irrigation	YES	N/A	Technology still in developmental stage	
Swimming pool covers for CI&I	YES	N/A	Need more data on-site specific savings	

FAILED ECONOMIC SCREEN				
New Drip Irrigation System: FULL COST (Assumes customer was not intending to install a system.)	YES	NO	Mtls. only including up-front costs	1,250 sq.ft. of plants
	YES	NO	Mtls. & labor including up-front costs	Same
	YES	NO	Mtls. only excluding up-front cost	Same
	YES	NO	Mtls. & labor excluding up-front costs	Same
	YES	NO	Mtls. only including up-front costs	2,500 sq.ft. of plants
	YES	NO	Mtls. & labor including up-front costs	Same
	YES	NO	Mtls. only excluding up-front cost	Same
	YES	NO	Mtls. & labor excluding up-front costs	Same
Convert Sprinkler System to Drip System FULL COST	YES	NO	Mtls. only	1,250sq.ft. of plants
	YES	NO	Mtls. & labor	Same
	YES	NO	Mtls. only	2,500 sq.ft. of plants
	YES	NO	Mtls. & labor	Same
Soil sensors (Install with automatic sprinkler; assumed to be hard-wired to controller) FULL COST	YES	NO	Mtls. only/3 zones, 1 per zone	2,500 sq.ft. landscaped area
	YES	NO	Mtls. & labor/3 zones, 1 per zone	Same
	YES	NO	Mtls. only/3 zones, 2 per zone	5,000 sq.ft. landscaped area
	YES	NO	Mtls. & labor/3 zones, 2 per zone	Same
Water- <i>effic.</i> plants replacing non- <i>effic.</i> plants (incl. \$100 per 500 sq.ft. for clearing) FULL COST assume all sprinkler system	YES	NO	Mtls. only	1,250 sq.ft. of plants
	YES	NO	Mtls. & labor	Same
	YES	NO	Mtls. only	2,500 sq.ft. of plants
	YES	NO	Mtls. & labor	Same
Water- <i>effic.</i> plants replacing existing plants (incl. \$100 per 500 sq.ft. for clearing) FULL COST assume drip sytem	YES	NO	Mtls. only	1,250 sq.ft. of plants
	YES	NO	Mtls. & labor	Same
	YES	NO	Mtls. only	2,500 sq.ft. of plants
	YES	NO	Mtls. & labor	Same
Turf replacement 50/50 to 20/80 at FULL COST	YES	NO	Mtls. & labor	1,250 sq.ft. of plants
	YES	NO	Mtls. & labor	2,500 sq.ft. of plants
Mulching FULL COST	YES	NO	Mtls. only	1,250 sq.ft. plants
	YES	NO	Mtls. only	2,500 sq.ft. plants

TABLE E-2 (Continued)

End Use	Pass Qual Scrn?	Pass Econ Scrn?	Candidate Measure	Description
Drip Irrigation System: Homeowner-installed FULL COST	YES	NO	Mtls. only - timer included	1,250 sq. ft. of plants
	YES	NO	Mtls. only - no timer	Same
	YES	NO	Mtls. only - timer included	2,500 sq. ft. of plants
	YES	NO	Mtls. only - no timer	Same
Bubbler/Soaker (Turbulent Wall Hose Fails) FULL COST	YES	NO	Dew Hose	1,250 sq. ft. of plants
	YES	NO		2,500 sq. ft. of plants
	YES	NO	Leaky Pipe	1,250 sq. ft. of plants
	YES	NO		2,500 sq. ft. of plants
Gray water system FULL COST	YES	NO	Low-tech syst/55 gal drum (incl. backflow)	Applic. through buried drip irrig - no leach field
	YES	NO	High-tech system	Applic. through buried drip or leach field
Cistern FULL COST	YES	NO	1,550 gal for season, no backflow device	Assume 184 day season
	YES	NO	8,500 gal for season, no backflow device	Same
Convert quick coupler FULL COST	YES	NO	Mtls. & labor	Two acres of turf
	YES	NO	Mtls. & labor	Five acres of turf

FAILED QUALITATIVE SCREEN

			Reason
Soil polymer (res. C&I)	NO	N/A	Better measure available
Autom. sprinkler syst. (res. only)	NO	N/A	Studies show homes w/ auto. systems use more water than homes w/ manual systems.
Swimming pool covers (res. only)	NO	N/A	Swimming pool covers have limited applicability for residential use in the region.
Artific. recreation surfaces (instit)	NO	N/A	All-weather recreational surfaces may be aesthetically unacceptable.
Grey water (C&I only)	NO	N/A	Environmental and health concerns
Misc. agric. measures	NO	N/A	There is a limited number of agricultural customers within the service territory.

[1] Base and candidate measure water consumption is based on provider data and on an evapotranspiration model.

Appendix F
SUMMARY OF RESPONSES
TO THE
AUGUST 1995 REGIONAL WATER SUPPLY PLAN
PRELIMINARY REPORT

Regional Water Supply Plan Fall Newsletter Clip-and-Mail Response Synopsis

The Fall 1995 Regional Water Supply Plan newsletter was mailed to more than 3,500 individuals, agencies and organizations. About 2,000 more have been distributed. To date, fifty-three "clip-and-mail" responses have been received. The vast majority of respondents reside in Portland. About half of these stated support for the planning effort and requested to be kept informed. A summary of the views on the preliminary plan is provided below. A more detailed synopsis is attached. *Note: No more than eight individuals commented on any one topic (number shown in parentheses). Some commented on more than one topic.*

Growth/Sustainability/Limits (5)

- Carrying capacity is being exceeded.
- Need sustainable balance between growth and resources.

Equity/Cost (3)

- New users should pay more / existing residents should not subsidize growth.
- Let new users have Willamette water.
- Stair-step plan implementation.

High-Tech Industries (4)

- Limit recruitment and tax breaks.
- Concern about pollution impacts.

Public Education (4)

- Use education as "preventive medicine."
- Conservation education is needed to help people change their behavior.
- Educate in schools and use the media.

Water Quality - General (5)

- Water quality is among some people's most strongly held values.
- Some expressed a desire to retain at least current level of water quality.
- Some do not trust treatment.

Environmental Protection (5)

- Some people expressed strong values regarding protection of the environment as key in deciding how to meet future water demand.
- Several emphasized the importance of source quality protection through watershed protection.

Conservation (8)

- Strong support (especially for outdoor conservation) was expressed.
- Respondents submitted a host of conservation ideas/suggestions.

Water Reuse and Recycling (8)

- There is strong support for and interest in use of treated wastewater, graywater, cisterns, and untreated groundwater and surface water.

Clackamas Option (6)

- There is concern about impacts on instream flows, fish, and "urbanizing" this "drinking water watershed."

Bull Run Option (8)

- Some strongly prefer Bull Run Dam 3.
- Bull Run might be a good source for aquifer storage and recovery.

Columbia River (8)

- Both support and concern for this option were expressed. (More were concerned about water quality, Hanford and paper mills.)

Willamette River (7)

- Both support and concern for this option were expressed.
- The majority of commenters on this option were concerned about water quality.
- Some noted that use of the Willamette will provide an incentive to clean up the river to the benefit of wildlife, people and the environment.

Aquifer Storage and Recovery (4)

- Both support and concern about this option were expressed. Concern relates to impacts on groundwater quality and suitability of aquifers

Groundwater (4)

- Concern about water quality
- Do wellhead protection and clean-up.

Public Involvement (2)

- Need more input before decisions.

Regional Water Supply Plan Fall Newsletter Clip-and-mail Response Synopsis

The Fall 1995 Regional Water Supply Plan newsletter was mailed to more than 3,500 individuals, and distributed to hundreds more. To date, fifty-three "clip-and-mail" responses have been received. The vast majority of respondents reside in Portland. About half of these stated support for the planning effort and requested to be kept informed. A summary of comments on the preliminary plan is provided below. A more detailed synopsis is attached. *Note: No more than eight individuals commented on any one topic (number shown in parentheses). Some commented on more than one topic.*

Implications of Growth/Sustainability/Limits (5)

Five individuals raised concerns regarding projected growth in the region and the implications of growth for water resources. There is concern that the carrying capacity of the region has been or will be exceeded. Commenters urge the establishment of a sustainable balance between growth and resources (including water, sewer, air) to sustain that growth. It was recommended that growth should be "regionally coordinated," and that economic planning should be such that a healthy economy does not rely on continual growth in population and resource consumption. Several individuals raised the concept of limits on growth. One person said "just say no."

Equity/cost (3)

It was suggested that "new users ought to pay higher incremental costs than burden existing users." It was also suggested that "Portland taxpayers and residents ought not to be forced to sacrifice quality to subsidize suburban growth" and to "let Washington County users finance their needs from the Willamette..."

One commenter requested that near-term (out to 25 years) costs be provided since costs change over time. Another requested that programs aimed at meeting 2050 needs be carried out in "stair-step fashion."

High-Tech Industries (4)

Four individuals expressed concern about the impacts of high-tech industries coming to the region. There are concerns regarding continued "recruitment" and tax breaks for these companies. One person cited potential impacts on the environment and future water source options from pollutants (they also mentioned agricultural runoff as an issue). Another person suggested that there be a limit on high-tech development in the region and that these companies should not "be released from tax responsibilities....". There is concern regarding the prospect that high-tech firms will use a lot of water while providing "low paying jobs" to local residents, "take profits out of state or even out of the country" and "don't support our schools or the services they are using."

Public Education (4)

Four persons cited and the need for and urged the provision of education (generally in the context of conservation and changing behavior toward the use of water resources). It was suggested education be used as a tool analogous to "preventive medicine" that people be offered incentives to attend educational workshops. Education in schools and through media was also encouraged.

Water Quality - General (5)

Three individuals stated that water quality (and "safety") was among their highest values. Some state explicitly that they did not want their drinking water quality to go down (e.g., "maintain our current standards or better for drinking water").

One person asked why good quality water needed to be chlorinated. Another suggested that bridges be designed and modified to "divert any chemical spills into a containment area instead of into the river." It was also suggested that chemical dumping into sewers be limited.

Environmental/Watershed Protection and Stewardship (5)

Five people provided comments specific to environmental issues. Several state that the environment was the most important value to them or one of the most important values. One person asked about plans to protect flora and fauna. Of these, three expressed concern specifically about watershed protection. One person stated that we need to "develop more protection for the region's watersheds...let's enact our value of stewardship of these streams by protecting them." It was suggested that roads be kept away from streams. It was requested that watersheds not be logged due to impacts on "purity and the efficiency of water storage." Concern about the effect of logging, mining, and urbanization in the Clackamas watershed was also mentioned.

Conservation (8)

Eight individuals stated their support for more aggressive conservation. (No concerns or opposition was submitted.) It was mentioned that "lawns are a big water guzzler." It suggested that land use laws require smaller lot sizes to reduce the amount of grass. One person asked for gardening information. Another urged that all new housing be required to install water saving toilets and plumbing fixtures. It was recommended that if large water users come to the region, to require that they "re-cycle water so no net water loss."

Water Reuse and Recycling/Dual Systems (8)

Eight individuals commented in support of water reuse and recycling, and a dual systems approach to meeting future water needs. Specifically mentioned were opportunities for use of treated effluent, graywater, and rainwater captured via cisterns (rooftop and below ground surface). One person expressed support for dual systems for all new developments. Several individuals suggested that Bull Run or equal quality water could be used in potable water lines while Willamette or similar quality sources could be used in separate non-potable lines. A couple of commenters referred to potential use of untreated groundwater and surface water for irrigation (e.g., golf courses, parks, lawns) and industrial purposes (washing ships, industrial cooling) Recycling fountains were also encouraged.

Clackamas River Option (6)

Six individuals raised questions and concerns about the Clackamas source option. Primary concerns involve impacts on instream flows and anadromous fisheries. Concern was also expressed about "urbanizing a drinking water watershed" and how pollutants will be removed.

Bull Run (8)

Six individuals expressed desire for Bull Run water in the future. Of these, four expressed support specifically for a third dam in the Bull Run watershed. The primary reason cited was raw water quality and minimal treatment levels.

One person asked if Bull Run could be used as a source for Aquifer Storage and Recovery "instead of spilling it or building a third dam."

One person expressed concern that a Bull Run Dam had been approved without public consent.

Columbia River (8)

Two individuals expressed support for the Columbia River option. One expressed surprise that it was excluded "even allowing for the presence of the Hanford project."

One person asked for more public information on the "health and degree of usage" from the Columbia River.

One person asked if withdrawals from the Columbia River accelerate the effects of contamination sources.

Four people expressed opposition to the Columbia River option. Pollution from Hanford (e.g., through groundwater discharge to the river) and paper mills were cited as problems.

Willamette River (7)

Three individuals expressed support for the Willamette River. This option was encouraged as a way to avoid future impacts on Clackamas River fisheries. It was also suggested by more than one individual that use of treated, filtered Willamette water will create a "greater incentive to clean up that river, which will benefit everyone - "wildlife, people, the environment." Another stated that "if the Willamette inlet were located downstream of Portland, Portland would be more careful to not pollute it."

Four individuals expressed concern or opposition to the Willamette source option. Water quality was cited as a reason for concern. One person felt that the Willamette option was "snuck in" to too many of the strategy alternatives. They cited that "it has been editorialized that the Willamette is a "jobs project" for the water industry. They feel that the pie-charts used to illustrate future source capacities are "minimizing or diluting the possible effects of Willamette water on the quality of drinking water.

Aquifer Storage and Recovery (4)

Four individuals expressed some interest in ASR and asked for more information. Of these, one supported the use of Bull Run water for ASR. Another expressed concerns about the potential for ASR to influence adversely the background quality of groundwater and expressed interest in learning about prospective ASR sources. It was suggested that aquifers on the west side of the region might not be suitable for ASR.

Groundwater/Wellhead protection (4)

One individual noted that they did not want to use water from wells due to water quality concerns.

One individual expressed interest in remediation of the Columbia South Shore Wellfield. Someone asked that pollution be "blocked" from affecting the wellfield or that a new wellfield be developed.

Another expressed strong support for wellhead protection using land acquisition.

Public Involvement (2)

One person asked that additional public workshops be held prior to making decisions and expressed concern that the decision-making process is too fast. They stated an opinion that the public is uninformed and that media attention to project details is insufficient. Another expressed concern that public involvement events are not held at convenient times (i.e., at openings of hunting and fishing seasons).

Storage (1)

One person noted that it would be beneficial to have more storage on the west side of the region.

Benchmarks (1)

One person expressed interest in discussing "benchmarks" for the Regional Water Supply Plan.

REGIONAL WATER SUPPLY PLAN

WASHINGTON COUNTY PUBLIC PLAN WORKSHOP

◆ ANY FUNDING SOURCES IDENTIFIED?

- The recommendations include an ongoing organization to evaluate and tackle these issues (how to pay, assess costs fairly, etc.) The continued regional cooperation may take the form of an intergovernmental agreement.

◆ NEWS REPORTS REGARDING BOTTOM FISH WITH CANCER AND BIRTH DEFECTS. PROBLEM WITH USING WILLAMETTE RIVER WATER BECAUSE OF RUNOFF, SEWER, CATTLE AND ESTROGENIC CHEMICALS. WE'RE SLOW TO RECOGNIZE HEALTH HAZARDS (E.G. CIGARETTES).

- Have had significant amount of work and technical reports address these issues. Pilot studies on Willamette and Columbia. Some studies even included water spiked with pesticides. Reports say treated water meets or exceeds all standards.
- Causes of fish defects not known. One study involved raising three generations of fish in pulp mill effluent and landfill leachate -- and could not reproduce deformities.
- Deformities may be genetic. By the time we get to Willamette (2035), if we get to the Willamette, we will know more.
- We don't want to underplay the issue.
- As we learn things, we'll have plenty of time to change our course, and treatment regimes are designed to be very conservative (multiple barriers).

◆ ESTROGENIC CHEMICALS MUST BE OXIDIZED

- And they will through ozonation, and other techniques.

◆ HOW CRITICAL IS IT IF SOME OF THE ENTITIES OPT OUT? ISSUES OF EQUITY COME UP

- Very interactive process - team approach will continue.
- Institutional issues are important to the participating agencies.
- The Preliminary Plan does not recommend a "regional" system, necessarily. Recommendation is for regional planning/coordination to continue in meeting future needs.
- The Steering Committee has talked about inviting more entities to join organization. The first effort included collective funding and sponsorship: quite unique.

◆ **THREE AREAS TO MAKE PROJECT GO**

- Source
- Finances - who will pay?
- Who will govern?

We're going a long way from making decisions without first taking a hard look at financing and governance. That will be one of the priority issues for any continuing regional discussions.

- ◆ **WANTS NEXT WORKSHOPS TO PROVIDE TYPED LIST OF ISSUES PREVIOUSLY DISCUSSED.**
- ◆ **ENVIRONMENTAL ISSUE IN BULL RUN LAST YEAR WAS SALE OF OLD GROWTH - NEED TO KEEP OLD GROWTH FOR MITIGATION.**
- ◆ **COMMISSIONER LINDBERG ARTICLE - NO WILD SALMON RUN ISSUES IN BULL RUN, ARE THERE? DOES HE ADVOCATE THE WILLAMETTE?.**
 - Commissioner Lindberg has not advocated the Willamette as a source -- although people have been urged to weight the tradeoffs.
- ◆ **WOULD LIKE TO SEE LITTLE SANDY; FEWER ENVIRONMENTAL PROBLEMS.**
- ◆ **COST: ONCE DAM IS BUILT IN BULL RUN OPERATING AND MAINTENANCE COSTS WILL BE LOW.**
- ◆ **WHO WILL PAY FOR THE TREATMENT? THOSE WHO WILL GET THE WATER?**
- ◆ **IF NO BOND MEASURE - HOW TO PAY?**
- ◆ **LITTLE HISTORY OF CATASTROPHIC EVENTS IN THE BULL RUN.**
- ◆ **IF SPILL IN RIVER - THERE'S NO WAY TO SEND ALARM.**
- ◆ **COULD CATASTROPHIC EVENTS HURT TREATMENT FACILITY ON THE WILLAMETTE?**
- ◆ **GOING TO BULL RUN IS NOT TOO FAR FROM POPULATION CENTERS - JUST LOOK AT LOS ANGELES.**
- ◆ **NO STUDIES TO LOOK AT COST OF CURTAILING GROWTH INSTEAD OF BUILDING SUPPLIES?**
- ◆ **IS REGION ARE WE STUDYING OTHER ALTERNATIVES SOLELY TO BUILD CASE TO GET FEDERAL PERMIT FOR BULL RUN?**
- ◆ **FUNDING: WE SHOULD CARE WHAT REGION'S WATER WILL LOOK LIKE 1000 YEARS FROM NOW. SHOULD WE USE INCREASED GROWTH TO PAY FOR NEW SUPPLY?**

- ◆ THE CITY OF PORTLAND SHOULD CURTAIL SUPPLYING WATER TO OUTSIDE AREAS. PAYING FULL COST WILL MAKE WATER USE LESS ATTRACTIVE.
- ◆ PORTLAND IS INTERESTED IN PROTECTING BULL RUN WATERSHED.
 - Concerned about allegations that Bull Run environmental effects are a smoke-screen. Numbers on owl habitat.
 - Last commercial logging was several years ago.
 - New dam would require removal of heart of habitat area.
- ◆ FISH: CONCERN IS SANDY RIVER MAINSTEM, DOWNSTREAM FROM BULL RUN. BROAD BASE OF CONCERN REGARDING COHO AND CHINOOK RESTORATION.
- ◆ WHERE WAS THE CITY OF PORTLAND FOR DECADES REGARDING ENVIRONMENTAL PROTECTION? ISN'T PORTLAND BEING INCONSISTENT WITH DAM #3?
 - Key players were different. Look to folks here and now.
 - We learn, and gain different views of our responsibilities.
 - Need cost information for environmental impacts
- ◆ OPTION TO DUMP WILLAMETTE RIVER WATER IN TUALATIN?
- ◆ CONTROLLING GROWTH? WE HEAR "WHY DON'T WE PLAN MORE?" HAVING TROUBLE COPING WITH GROWTH.
- ◆ THE PARTICIPATING AGENCIES HAVE WORKED WITH METRO THROUGHOUT THE PROCESS. LAND USE AND WATER PLANNING GOING ON TOGETHER.
- ◆ SURPRISED TO SEE OREGONIAN REPORT THAT THE WILLAMETTE RIVER WATER WOULD BE PUMPED UP TO CHEHALEM CR.
 - Idea was raised in context of supply, wastewater management, and irrigation, could address many of the issues. Today, it is difficult to develop these types of major infrastructure facilities. USA addressed with Level IV treatment. For water supply, makes sense to go proximate to demand.
- ◆ IS REUSE BEING CONSIDERED? STATUS? IT TAKES LOTS OF WORK.
 - Agree in near term strategy.
 - Level of treatment varies.

- We should explore, conduct pilot projects, etc.
- Reuse may play a key role in certain parts of the region and future uses.
- ◆ FLOWS IN TUALATIN HAVE INCREASED WITH GROWTH. THERE IS NOT A TEMPERATURE PROBLEM (MAY BE MORE THAN FLOWS). LOOK AT DEMAND BEFORE GOING INTO PRISTINE BASINS
- ◆ PORT PROJECT: EXAMPLE OF PILOT PROJECT.
 - City of Portland exploring with Port of Portland the possibility of using untreated river water (e.g., ship washing) instead of Bull Run water.
- ◆ COST EFFECTIVENESS OF CONSERVATION - COMPARE COST OF SOURCES AND CONSERVATION.
 - How many low flush toilets would supply a chip plant?
 - Looking at all costs, 3rd dam in BR is most expensive.
 - Low flush toilets as resource - saves water when we don't necessarily need it - (e.g., winter). Government standards require low flush toilets, which was considered in the Plan as "naturally occurring conservation."
- ◆ REGARDING WATER SAVINGS AND CONSERVATION: BE SURE TO CONSIDER EFFECTS ON REVENUE?
 - The impact on government revenue has been considered in the plan. The impact on rates and bills will have to be considered, ultimately.
- ◆ DEALING WITH GRAY WATER (LOWER BILLS?)
- ◆ CONSERVING A UNIT OF WATER IS REVENUE LOST. NEED TO ADDRESS THIS POINT AS WE IMPLEMENT.
- ◆ ALSO PUSH OFF DATE OF COSTLY NEW SUPPLY - AN AVOIDED COST IS AN ECONOMIC BENEFIT. THE DATE CAN VARY.
- ◆ WILL WE BE IN A CRISIS WHILE WE ARE DELAYING NEW SOURCES? WILL A CRISIS BE USED BY GOVERNMENTS TO FORCE THE PUBLIC TO GO ALONG WITH UNSATISFACTORY ALTERNATIVES IN 20-30 YEARS?
- ◆ WHAT IS METRO'S ULTIMATE ROLE IN THE WATER SUPPLY ISSUE?
 - Regional framework plan - Water supply planning element in Metro charter. Metro executive has said NOT interested in taking on water supply. Metro council is participant in this water planning process and will adopt the plan.
- ◆ CONCERN THAT IF IT IS OK TO DRINK MULTI-PURPOSE SUPPLY (E.G. WILLAMETTE), WHAT WOULD THEN STOP PORTLAND FROM ALLOWING RECREATION AND DEVELOPMENT IN BULL RUN.

SEPTEMBER 27, 1995

MULTNOMAH COUNTY PUBLIC WORKSHOP

Oregon Convention Center

- ◆ Since pure water has been provided by Portland to other communities for years, hope that these other communities will share the costs. It seems likely that other cities will have to use the Willamette and the Columbia in the future. Dual systems (potable and non-potable) should be explored, as should reuse of wastewater.
- ◆ Since the projections suggest that shortages will not be occurring in the "East node," but that the real need is in the South and West, who will end up bearing the cost of developing new supplies? Responsibility? Equity? [Answer: In conducting the RWSP, we have been guided by the premise that form follows function--in analyzing potential organizational means of providing new water supplies--and with the understanding that costs should be borne by those who benefit.]
- ◆ Not convinced of the need for a regional plan, or, for that matter, regional solutions. [Answer: It only makes sense to coordinate planning efforts, and to share the burden of the analysis. Through this joint effort we have identified near term and long term needs, as well as alternative strategies for meeting both. In working together, the region's providers are saving money, enhancing efficiency, and avoiding the often frustrating conflicts associated with multiple independent efforts.]
- ◆ What is the potential for using "grey water" for industry, or in a dual system? [Answer: The RWSP reviewed non-potable issues briefly, and as an express near term priority the plan calls for intensive analysis of this option. There are examples where reuse/non-potable uses are being employed, including the Portland and Port of Portland example, and pilot projects in Washington County involving the Unified Sewerage Agency.]
- ◆ Feel that the public's probable fear of other sources should be taken into consideration, especially due to historical water quality problems on the Willamette. The recommended strategy should be delayed until we know more about the Willamette River's water quality. We should wait until the DEQ Willamette River Basin Water Quality study is completed. [Response: In the recommended strategy, the Willamette would not be used as a source for another 40 years. This gives the region plenty of time to conduct additional studies, participate in efforts to enhance the quality of the river, and to learn more about improved treatment technologies. If the additional information suggests the Willamette should not be used, there is ample time to change direction, as contemplated in the RWSP, and turn to another source of water. During the course of the RWSP effort, water quality and treatment evaluations were conducted, including a pilot treatment plant on the Willamette River. From these analyses, a conservative treatment regime, with multiple treatment barriers, was developed--such that the treated water would surpass state and federal standards. Finally, there are tradeoffs involved with any source. Development of the Willamette would create a relatively low impact on the environment, for example. Other sources may have better water quality but present a much greater impact on the environment.]

- ◆ Opposed to shipping our problems somewhere else. One of the good things about drinking water from the Willamette River is we'd think a great deal more about what we put into it. Additional information, as well as the amount of time before implementation of a Willamette River source, is helpful.
- ◆ A USGS staff member said that the USGS/DEQ Willamette River Study is not focused on drinking water. Rather, it focused on the ecological health of the river. The Willamette is in far better shape than it used to be. [Response: In context, the Willamette River would not be a major source of the region's future water. Even if growth occurred at the highest projections, in 50 years the Willamette would be providing only between 5-10% of the region's water.]
- ◆ The region should select the Bull Run, and go with our strengths.
- ◆ Do we know what sort of demand all of the high tech and chip plants will cause? [Answer: It is difficult to accurately project in the future, but it is expected to be limited. A White Paper on high tech industry water demand will be available soon.]
- ◆ Isn't it ironic that a new Bull Run dam scored lowest in terms of environmental impact? Shouldn't the Bull Run get extra credit for over 90 years of watershed protection? [Response: Because of the destruction of old growth forest and significant owl habitat, as well as impact on streamflows needed for anadromous fish in the Sandy River, a third dam on the Bull Run River did not score as high as other sources with less environmental impact.]
- ◆ Wouldn't the prospect of radon in groundwater be exacerbated by the ASR option? [Answer: Before any ASR option goes on line, additional studies and pilot projects will be needed to answer this question as well as many others that we don't know enough about at this time.]
- ◆ How soon do new transmission lines have to go in? What drives what—the new sources or where the new lines happen to be constructed? [Answer: New transmission lines should be planned and built to anticipate future demands and sources, and should be large enough to allow for future use. Otherwise, it would be very expensive to dig them up and replace them with larger lines. And since the water which could be taken from the Willamette is relatively small, it would not dictate other pipelines.]
- ◆ The highest and best use of Bull Run water is indoor and domestic use. We should maintain the historic purity of the Bull Run. Let other communities use lower quality water supplies. Portland should use Bull Run for domestic uses, and offload all non-essential uses to a non-potable system. We are being arrogant if we think decisions made today will have any impact 40 years from now—things and politics change.
- ◆ Tucson found that recycled water worked well.
- ◆ Would like to see a strong component in the plan addressing pricing as a conservation tool. Block rates and other pricing mechanisms would induce changes in consumer behavior. [Response: Pricing was evaluated as part of the conservation analysis, and more work needs to be done with each agency. Some agencies, such as TVWD and Portland, have adopted pricing mechanisms.]

problems.

- ◆ Has a study been done to determine the public's willingness to pay higher rates? [Answer: Yes, a contingent valuation survey.]
- ◆ Has anyone taken into consideration the potential increased personal cost of home filtration systems and bottled water (should an option other than the Bull Run be chosen)?
- ◆ The annual costs of protecting the watershed and source water would be less with the Bull Run than they would with the Columbia and Willamette Rivers. (Check the Portland Water Bureau and USFS budgets for watershed management.) Maybe we will have to save the Willamette from ourselves (be cleaning it up) but we would still have to drink it.
- ◆ Disagree with the assumption that the Bull Run would have to be filtered. Estimates that building a third dam would cost a great deal more than some others (in part because a filtration plant would be required) are inappropriately inflated. [Answer: Costs for treatment plant were not included.]
- ◆ Need to consider the potential impact of interbasin transfers—on the environment and on streamflows.
- ◆ Support the Clackamas River option, because it seems that there is plenty of water. Also likes the Bull Run.
- ◆ Portland residents should continue to have access to cleaner water because they live in the City, and have continuing expectations of receiving high quality water.

SEPTEMBER 28, 1995

CLACKAMAS COUNTY PUBLIC WORKSHOP

North Clackamas Chamber of Commerce/OIT
Conference Center

- ◆ Transmission lines—can existing lines be increased in size to avoid the need for constructing a new one? Will the lines be built to allow water to be transferred in more than one direction? [Answer: The analysis considered the optimal size for lines which might be required for particular water supply sources. In the recommended strategy, a bi-directional transmission system is contemplated.]
- ◆ What happens in quasi-rural areas which are relying on individual wells when increased development reduces the amount of water in the aquifers? (A particular question from a long time homeowner outside of the UGB.) [Response: Water which might be developed through the RWSP would not serve the needs of residents in these areas anyway, but it would appear that tighter land use controls on the County level are needed to limit the number of new homes allowed—based on the amount of water available.]
- ◆ It may no longer be appropriate to use Bull Run water for industrial uses, as well as drinking water purposes.
- ◆ Concerned with poor land use planning on the part of Clackamas County.
- ◆ What is the potential impact on Clackamas River flows if it is selected as an option? [Answer: We have some information, but one of the first steps if the Clackamas is implemented is to conduct an IFIM analysis to gauge the streamflow impact that option would have.]
- ◆ Regarding ASR: What is the potential impact on existing wells in the ASR areas? Are there deeper aquifers? How soon will the ASR sites be developed? [Answers: ASR could be on line within ten years. Although ASR has been successfully employed in many parts of the country, intensive analyses will be conducted to answer a number of questions—such as, what will the impact be on neighboring wells? What water quality and treatment issues are there? Will it work in Oregon? Etc. A pilot ASR site would also be conducted to ensure it's feasibility.]
- ◆ Groundwater is a resource, and it has to be protected.
- ◆ Advises against rigid, uniform, regional conservation standards which might not be reasonably applicable in all areas of the metropolitan area. Some areas, it was suggested, might have soil which is too sandy for some of the landscape irrigation standards, for example.
- ◆ Concerned about the Clackamas flow impacts of storage and releases from existing dams.

- ◆ What is the process for making a decision and involving the public and environmental organizations? [Answer: There will be additional hearings at each of the cities and districts, as well as further regional meetings, to learn about concerns, accept input and suggestions for change, and prepare a draft final plan for further review. Additional opportunities will be provided to comment upon the draft final plan later this year and early in 1996. A wide array of public information and involvement techniques have been employed over the past two and one half years, designed to garner input that has been integrated into the preliminary plan.]
- ◆ Are there still efforts in place to consider expansion of the Bull Run watershed to include the Little Sandy River?
- ◆ There are a number of water rights issues in the Willamette River that must be considered, especially involving PGE. Don't see the same sorts of water rights problems associated with the Bull Run.
- ◆ The fish issue in the Sandy River will require more information, as well as greater agency coordination.
- ◆ Should consider getting local television and radio stations to provide more coverage of this study, or at least provide free time to discuss it or announce events (e.g., through a PSA).
- ◆ Cost factor will be significant. How much more will water cost in the future, especially if bonds—with associated financing costs—are sold to implement any of these options?
- ◆ The region's water providers are to be commended for engaging in this long term planning.

Summary of Participant Entity Responses to the 1995 Preliminary Regional Water Supply Plan

Introduction

All of the 27 jurisdictions participating in the Regional Water Supply Plan (RWSP) were asked to answer four common questions about the preliminary RWSP distributed as of September 1, 1995. Using this approach, the large number of jurisdictions that have participated in this project since May 1993 would be encouraged to respond in a manner which facilitates comparisons and allows for a synthesis of responses. This document and the attached matrix is a summary of the responses submitted by the water providers. The full comments will be attached as an appendix to this report when completed. In addition, this summary report will be attached as an appendix to the final RWSP when it is completed. Responses to parts of questions one, two, and four, which are amenable to a matrix listing of the individual responses, is an attachment to this report. For each question and those parts of the questions for which a simple tally is not adequate, the following text has been prepared to summarize the nature of the responses.

As of April of 1996 all but one of the participants in the RWSP had provided a written response to the four questions. The entity that did not respond is the South Fork Water Board (made up of the cities of West Linn and Oregon City). Their lack of response was due to timing problems related to events involving their own system (new intake construction, flood damage, and rate vote) rather than a lack of support for regional supply planning.

Question # 1

In the preliminary Regional Water Supply Plan (RWSP) prepared by the water provider staff there are a number of long term supply resource strategies which are presented. The providers have recommended one of these long term strategies based on an equal balance between the various key policy values which were identified during the project. The choices presented in the plan, however, allow decision makers to select other alternatives based on different policy value emphasis. Which of these key policy values are most important to you in meeting your future water needs?

Costs

The efficient use of water

Environmental impacts

System reliability

Diversity of sources

Quality of the water sources (including factors of raw water quality, treatment levels required, and protectability of the upstream watershed)

Are there other policy values that are equally or more important to you, if so what are they?

Responses:

Of all the questions this is the one yielded the most diverse answers and methods of answering. Some jurisdictions simply ranked the key values in order of priority (e.g. Oak Lodge, Troutdale, Wood Village, and Sherwood); others selected certain ones but didn't prioritize them all (Hillsboro, Portland), a number of others selected their key values only and gave no ranking (Metro, Beaverton, Wilsonville, Milwaukie, Gladstone, Fairview, Canby, and Sandy). There was no requested method for answering this question.

In general some themes do emerge from the answers. A number of the participants singled out particular policy values as being important to them. Diversity of sources was a key value for Fairview, Forest Grove, Gladstone, Milwaukie, Sandy and West Slope. Oak Lodge and Damascus pointed out the importance of flexibility for meeting future needs, Metro and Lake Oswego noted that coordination of this plan with growth management strategies was important. Wilsonville specifically pointed out that they have more immediate supply needs than the region in general and that a key policy value for them is,

"...the degree of certainty that the adopted strategy can reliably meet subregional needs for water in the year 2000 and beyond." (Wilsonville)

This value was also called out by the City of Sandy

"retain the ability for individual water providers to develop sub-regional sources to meet projected near term needs, in particular to preserve the ability of the City to develop its Salmon River source" (City of Sandy Resolution #4-96)

There is diversity between the entities choices for their top values, two striking areas are system reliability, which is the highest value for a number of entities while it is of lessor importance to others.

Reliability

In the case of five entities 100% reliability was their highest value. 14 of the participants ranked this value as either their highest or one of their highest values.

"We strongly believe that the resource strategy which is adopted regionally should provide for 100% reliability in terms of having the capacity to meet peak needs during the driest years based on historical records." (City of Hillsboro)

"Reliability of source is our number one concern for the future. We must plan for 100% reliability to provide the region with a choice of resources that will meet their needs when the time comes. Flexibility in future sources is key in this planning process and all the supply scenarios considered can meet the region's needs." (Oak Lodge Water District)

Yet in the case of the Portland, Metro and Damascus responses there is a specific recommendation that the region consider some lessor level of system reliability for meeting the maximum hottest summer peak days.

"Give the strongest consideration to adopting a 'reliability' level less than Level 1 as defined in the Plan. The Council believes that it is not sound policy to expend significant economic and environmental resources to construct new facilities merely to assure that outdoor water use will never be limited during the driest 1-5 day periods of exceptionally dry years when very short term 20-30% reductions of outdoor use can meet the need." (City of Portland Resolution)

"The Metro Council believes the issue of planning for curtailment during drought should be addressed. It encourage the study's steering committee to examine the cost of continuing to provide water with high reliability versus curtailment of use during periods of drought. The Metro Council believes that the public should be educated and involved in managing demand and that higher reliability can be obtained through different strategies." (Metro Resolution Exhibit B)

The issue of system reliability is one where there is some significant difference of opinion about how the final plan should address this issue.

Water Quality

A significant number of entities (8) rate water quality as one of their highest values. The emphasis on source (or raw) water quality was specifically called out as the City of Portland's highest value. Metro notes that all citizens in the Metro region should be assured high water quality. Several entities made a specific point that water from any of the identified sources is treatable and can provide high quality drinking water (Hillsboro, Clackamas River Water, West Slope Water District, Beaverton, Wilsonville) Many entities specifically support watershed protection as very important to making sure that all drinking water sources are better protected and that reliance on treatment can be reduced (Portland, Metro, Clackamas River Water). Portland, Metro and Tigard specifically note that efforts to clean up the Willamette River should be a high priority.

Sustainability and Environmental Impacts

Portland, Metro, Beaverton, and Damascus emphasize principles of sustainable development be integrated with near term strategies so that expensive and/or environmentally impacting source development and treatment costs can be delayed and reduced over time. These strategies are elaborated upon at length in their responses and are covered in this report in Question #3.

Cost Equity

Portland and Damascus also note that cost and equity issues are very important. Lake Oswego suggests a change in the second policy objective contained in the plan regarding Economic Costs. They would like to see a specific language change that clarifies that existing ratepayers should not have to subsidize growth.

"In addition, Portland and others have heard throughout this process that cost equity is a major priority for existing customers. The costs of development of new supplies must be borne throughout the region by those entities which require and would benefit from new supplies or programs on a cost equitable basis." (City of Portland, Exhibit A)

Source Diversity

Diversity of sources is specifically called out by some entities (11) as being an important criteria for meeting future water needs and being able to respond to catastrophic events more effectively.

Growth

Metro notes that for them that coordination between the RWSP and Metro's growth management decisions is a high policy value for them.

Question #2

Do you agree with the recommended strategies contained in the Preliminary Regional Water Supply Plan? If so, why? What strategies specifically do you not support and why?

The matrix contains a tally of the "yes/no" responses to the first part of this question. The majority of respondents favor the recommended strategy, with 17 entities supporting recommended strategy, six not supporting the strategy, and three not taking a position. Those supporting the strategy represent 70% percent of the growth forecasted in the medium growth scenario to occur in the metropolitan region by 2040. The geographic mix of those supporting the strategy are suburban centers, particularly located in Washington and Clackamas Counties, but also including the City of Gresham in Multnomah County. Metro and the City of Portland express desires to see changes in the recommended long range strategy of the plan and enhancements to some of the near term strategies. These two responses are dealt with at the end of this section and in the responses to Question 3 because of the level of detail those entities provided.

Some of the entities supporting the recommended strategies note this and provide some additional comment.

"It is our belief that resource sequence 1.5 and the related strategies effectively meet the key policy objectives and offer significant flexibility in meeting future demands. This strategy represents a reasonable balance of the tradeoffs necessary for any of the source options." (Clackamas River Water).

"We do believe that any of the five example level 1 reliability resource sequences could meet the regional demands, and strongly believe that we must keep all of these source options available for the future" (Oak Lodge Water District).

"We agree with the recommendation that the resource sequence 1.5 and the related strategies meet the key policy objectives. Again, flexibility

and reliability are issue that cannot be overlooked in meeting future needs, and is significant in this resource sequence. This strategy offers the most reasonable balance of source options while incorporating a good balance of tradeoffs to achieve quality sources." (Tualatin Valley Water District).

"We realize that with 27 different water provider in the region, there will probably always be differing views in deciding the "best approach". As stated in the preliminary plan document, the final product is a set of resource strategies that best meet the region's needs as expressed through the policy objectives and that a single "best" future resource strategy for the region does not exist. The plan recommendation reflects tradeoffs the region must make among the policy objectives." (Beaverton)

In addition, a number of entities that support the recommended strategy also emphasized their support of conservation as a critical element of the selected strategy (TVWD, Clackamas River Water, Hillsboro, Oak Lodge, Tigard, Milwaukie, and Fairview). The work of the existing Columbia-Willamette Water Conservation Coalition is cited as a good forum to begin immediate consideration of implementation strategies.

Specific strategies which were not supported certainly must include mention of concern about the water quality of the Willamette River. This issue is noted by a number of entities. Wood Village, which supports the recommended strategy expresses reservations about the Willamette River. Troutdale does not support the recommended long term strategy and expresses concern about the Willamette River. Troutdale also notes concern about a "one size fits all" approach to a regional strategy which may not be appropriate for the smaller providers that have individual sources.

Damascus did not support the long term strategy primary because they felt that a different level of system reliability should be considered. Mt. Scott does not support the long term strategy and notes:

"The District does not necessarily support Option 1.5 as the best alternative; however, the District does support the concept that all of the supply options should be considered as future supplies. The District believes these options need further investigation and additional refinement before any decisions are made as to "a final" scenario. The District's recommendation does not necessarily preclude the Willamette River or the Columbia River options as possible resources" (Mt. Scott WD)

Portland's response is to not support the recommend long term strategy. Portland has committed itself to maintain Bull Run for its sole source of water supply beyond the end of the plan's time horizon. In addition Portland notes:

"Because the debate over the recommended strategy has focused so intently on inclusion of the Willamette River as along term supply source it has become difficult to focus on the broad range of real issues at hand. While we recognize the providers' efforts to meet a range of policy objectives, we cannot support the recommended Strategy 1.5 as specified in the preliminary plan" (Portland, Exhibit A)

Portland states that the recommended strategy does not meet their broad objectives. The Portland City Council has requested that the region's providers put more emphasis on "green alternatives" to delay the need to develop new sources, develop a lesser level of peak event extreme hot weather availability, craft a plan which can respond to different policy emphases in various parts of the region, and develop criteria to ensure equitable financing for needed program and facility improvements.

Metro's response also notes a lack of support for the long term strategy:

"Metro does not accept or adopt the preliminary Water Supply Plan in its current form" (Metro resolution)

Metro supported part of the recommended strategy and not others. The Metro Council expresses support for conservation as the first resource to pursue, however, they would like to see the revised plan include cost effective indoor measures. Metro further expresses concerns about the use of the Willamette as a potable drinking water source, but noted, "The Metro Council, however, recognizes the need to maintain a regional perspective when evaluating future source options." Metro is very supportive of continuing efforts to clean up the Willamette River to ensure higher water quality. Further concerns were expressed by Metro about the need to do further research on ASR and to adequately protect lands over ASR sites. In addition, concerns were expressed about the use of the Clackamas River on fisheries there and recommends that an IFIM be conducted on the River before additional withdrawals are instituted. The Council also expressed reservations about the development of further storage in the Bull Run system due to environmental impacts and the lack of flexibility inherent in bringing on line a very large new source of water.

Question #3

What changes would you recommend for consideration in the final RWSP? Why?

Not all entities provided an answer to this question. Many of those that supported the preliminary plan recommendations did not elaborate further. However, additional comments from those supporting the recommended strategy include the following:

- Provide additional efforts to ensure proper watershed management on the Clackamas River (Oak Lodge Water District)
- Provide adequate monitoring of the plan to ensure that implementation keeps pace with identified needs (Hillsboro, Oak Lodge WD, Beaverton)
- Plan implementation needs to start on a sub-regional level and periodically reviewed. Regional transmission and inter-connection needs to have a higher priority in the Plan. (TVWD, Beaverton, Wilsonville)
- All of the options considered in the preliminary plan are still viable including the Columbia River as a potential source option (Rockwood PUD, West Slope WD)
- The near term system expansions projected for the Clackamas River should be recast in the final draft plan so that the 22.5 mgd is not

agency specific. This will allow the Clackamas entities the near term strategies based on subregional coordination (Clackamas River Water)

- ASR needs to be carefully evaluated before implementation to ensure that the costs are acceptable with the water which can be recovered (West Slope WD, Wood Village)
- The viability of using the Willamette is questionable (Wood Village)
- Emphasize conservation of potable water and substitution of non-potable river water and reused wastewater for non-potable uses (Beaverton, Tigard)
- More grass roots education (Tigard)
- Investigate regional pricing options (Beaverton)
- Protect the flexibility for individual water providers to develop sources to meet projected short-term needs, in particular for the Willamette River (Canby Utility Board, Wilsonville)
- The Plan should include more discussion of the water quality issues of the new sources and the treatment processes and fail safe contingencies to assure that water delivered to the tap indeed meets drinking water standards (Wilsonville)
- The conclusion in Chapter VIII that Lake Oswego should meet its forecasted 2050 demand deficit via connection a regional transmission facility in the west node is not acceptable, they wish to remain primarily serviced from sources in the south node (Lake Oswego)
- Plan flexibility is the hallmark of the preliminary plan approach:

"One of the greatest advantages to this integrated water resource planning process is that it gives us the opportunity to decide the appropriate action at any time in the future. We can continue to evaluate timing for supply additions along with finding answers to questions about whether the chartered course is, indeed, available, and whether the demands are similar to our projections." (Hillsboro)

- Diversity of sources and relationship to catastrophic event reliability needs to be emphasized more in the final plan:

"We would recommend additional recognition of and provision for diversity in overall supply, particularly in light of recent natural events which have had major impact on the Bull Run system and others in the metropolitan area." (City of Sherwood)

Some of the entities not supporting the recommended long term strategy 1.5 provide detailed specific changes that they would like to see. Mt. Scott WD indicated a lack of support of any recommendation of a preferred scenario and recommended that all sources be part of an overall strategy with no deletions at this point. Decisions on which sources to develop would be made over time.

Metro references an 11 page attachment which provided the following suggested changes:

1. Water Conservation - Move several of the Level II & I measures into Level III, such as ULF toilet rebates and education programs. Consider combining Level II and III together into a more aggressive overall conservation program. Also explore full implementation of cost-effective conservation scenarios before any new sources are brought

on line. Metro should have a role in conservation implementation. Each strategy should include the most cost effective strategies in both indoor and outdoor areas in order to gain a more effective customer commitment by being more comprehensive.

2. Aquifer Storage and Recovery - Questions about ASR should be researched and investigated as soon as possible.
3. Regional Water Pricing - Region wide water pricing must be implemented if water conservation is going to be successful, Metro supports the recommendations in the plan but would like to recommend that all providers in the region implement an aggressive conservation rate program.
4. Wastewater Reuse and Non-potable Options - Metro recommends that institutional reuse be focused upon rather than residential or business level development. Public education is recommended also.
5. High Technology Water Demands - Closely monitor the impacts of these users on demands and implement aggressive industrial water reuse and conservation programs for this sector.
6. Finance Recommendations - The draft final plan should identify a basic financing strategy or polices to guide future financing decisions. The final plan should also address revenue losses water providers will experience in conjunction with water conservation programs.

Portland included a 10 page attachment to its resolution, Attachment A details the following recommendations:

- A. *Greater emphasis on the development of "green alternatives"* - Portland recommends revising the plan to include other conservation programs such as education and more comprehensive programs in the non-residential sector (particularly high consumption users). Conservation targets should be explained in the implementation strategies. The plan recommendations pertaining to non-potable, recycling, and water reuse should be expanded to include:
 - more detailed regional examination of wastewater reuse
 - changes to plumbing codes to allow for graywater systems
 - exploring linkages between surface water management and water supply programs
 - exploration of opportunities for dual-systems
 - assessment of potential water transfers to enhance non-potable opportunities
 - demonstration of ASR technologies
- B. *Regional cooperation and the development of staged long-term strategies* - Portland suggests that the plan be recharacterized in the areas of the long-term strategies to recognize the iterative, dynamic, and cooperative nature of the proposed implementation strategy. In particular the plan should reflect the uncertainties associated with the decision-making process in the long term. Portland suggested a staged approach which includes:
 - Stage 1 - conservation and non-potable sources: completion of near-term strategies, and the formation a region consortium of water providers to implement the plan. This stage is thought to span from the present to about 2020. Included here are specific strategies to protect the viability of future source options, particularly watershed efforts to ensure the cleanup and protection of existing and potential drinking water sources, small source development and demonstration,

and regional partnerships to effectively explore and implement conservation programs, pursue non-potable supplies, and explore the development of less reliable systems for meeting the extreme peak demands of hot weather years.

Stage 2 - Major option selection and implementation - This stage may not involve a great deal of water source development if the first stage is successful. Long range alternatives would not identify particular sources, but would focus on keeping all options viable for the future and open for consideration at the appropriate times. The final plan should specify that the following list of variables would be considered in characterizing any long range supply options:

- actual growth and revised growth forecasts,
- actual savings generated by conservation programs,
- determination of desired reliability for hot summer periods based on avoided costs and tradeoffs,
- current conditions and information regarding key issues such as water quality, environmental needs, etc.,
- actual and potential ability to rely on water recycling, reuse, and other high efficiency technologies, and
- direct use of lower quality water sources for end uses which do not require potable water.

C. *Minimizing environmental impacts* - Portland requests that plan recommendations be amended to acknowledge the value of the region's watersheds, aquatic resources, and fisheries. Protection of watersheds and further exploration in pollution problems and effects should be emphasized.

D. *Cost efficiency and equity should be more formally addressed in the plan implementation strategy* - Portland asks that the plan provide some clearer policy direction and possible short and long term strategies to meet the existing policy objective related to equitable financing of needed system improvements. The plan should establish a basic tenet that those who benefit from system improvements should pay for them. Those programs that are more effectively carried out regionally should be implemented in this manner. Partnerships to demonstrate the effectiveness of the conservation and reuse, exploration and possibly development of new source options, and transmission interconnections should be early implementation tasks for a regional consortium.

Question #4

Do you support the concept of forming a formal consortium of water providers through the adoption of an intergovernmental agreement when the final RWSP is adopted? What types of functions do you think the region's water provider should carry out in a cooperative approach? If you do not support a formal organization how would you recommend that these functions be carried out?

Most of the entities (24) support the formation of a regional consortium through an intergovernmental agreement (IGA), but one does not (Wood

Village), the Rockwood PUD is supportive but would like to see more details, and Troutdale does not believe such a group needs to be formalized through the adoption of an IGA. The City of Sandy did not respond to the question. A general sentiment expressed was:

"We very strongly support continuation of the cooperation that has been established throughout this project. An intergovernmental agreement among water providers will help continue that cooperation, while assuring that water needs in the region are effectively met. We hope that other providers who have not been participants in this Phase II process will also join in that agreement. Tremendous accord develops as we work closely together - and residents and businesses in the region reap the benefits." (TVWD)

Support for the formal consortium is qualified by some of the participants:

TVWD - Wants the agreement to be flexible so that cooperation can evolve over time

Wilsonville - does not want an agreement to be lengthy, complex, or expensive but is supportive of this organization providing "good offices" for discussing/resolving issues that impact two or more water providers within the region. They also note that this organization should represent consensus positions to other agencies

Sherwood - cautions against an organization which adds layers and costs beyond the value derived. Would be willing to work towards the development of a modest and focused approach.

Damascus - functions should include water supply planning and development, transmission main planning and development, and financing and rate review process. Ways must be found to distribute costs among members in a fair manner. Rates should be kept within guidelines following policies established for efficient use of water and conservation

Lake Oswego & Gladstone - expressed concerns about creating another level of government and would desire to see an ongoing organization work within existing governmental structures utilizing existing staff and resources to the maximum extent possible

Hillsboro - supports the listed functions in the preliminary plan, except the last one regarding proposals on possible changes in institutional arrangements. The organization should not have too large of an agenda to start and should be allowed to grow over time.

Tualatin & Tigard- a consortium should work to coordinate or implement financing of sources when needed or other items as appropriate

Clackamas River Water - supports the formation with general by-laws so the group can formulate and appropriate and effective work plan. Supports the potential list of functions in the preliminary plan, but the details should be worked out after a final plan is prepared.

Portland - The charter of such a group should make it clear that:

- The cost of supply development are allocated as precisely as possible to the beneficiaries
- Local governments retain decision authority over components of plan implementation, including subregional development, and that future revisions of institutional arrangements are voluntary
- Partnerships are encouraged to responsibly enhance water supply and reduce water demand through conservation and efficient-use strategies (Tigard and Wilsonville also raise similar points)
- Planning decisions and implementation are done in a timely manner
- Watershed protection should be one of the goals of such a group as well as protection and enhancement of existing and potential water sources

Metro - Supports the formation and listed some very specific functions. Some of the suggested function repeat those in the preliminary plan and some are new. In addition Metro provides some comment about its future role in regional water supply planning. The Metro Council places particular emphasis in active participation and leadership in regional water conservation and education, as well as using its land use authority in coordination with local jurisdictions to implement regulation, standards, codes (including the building code) and incentives for land use, . Metro also commits its support and encouragement of watershed planning, wellhead protection and research to address outstanding issues in plan implementation. Metro's specific list of suggested functions for a regional water consortium include the following:

- a. setting benchmarks and interim targets to monitor and measure implementation of the plan;
- b. coordinating with other agencies, organizations and jurisdictions on all aspects of plan implementation;
- c. conducting formal periodic reviews of plan implementation every five years and reporting on progress in achieving the goals of each aspect of the plan (i.e., are regional water conservation targets being met?);
- d. identifying interim measures to achieve plan goals based on the results of plan implementation review;
- e. sharing information among providers and participants in the consortium;
- f. coordinating regional water conservation activities, monitoring progress and revising programs based on pilot testing results;
- g. developing and coordinating an aggressive public education campaign regarding all aspects of plan implementation. Keeping public informed about how targets are being met or not met, identifying new strategies to meet conservation targets and ensuring a regionally comprehensive education program;
- h. monitoring base case implementation;
- i. seeking funding for and coordinate different research projects with relevant agencies/jurisdictions;
- j. identifying financing options for each stage of plan implementation;
- k. coordinating with Metro Region 2040 project; and
- l. conducting pilot testing of aquifer storage and recovery.

Metro further expressed the desire to be a full member of the consortium, with specific tasks and responsibilities to implement the adopted plan. The Council recommends that it may be advantageous to have other entities, agencies and organizations as members of the consortium to facilitate implementation. This thought is also raised by Beaverton which notes:

"It is recommended that the consortium should somehow involve influential regulatory agencies and water customers in an advisory capacity to the voting body of 27 water providers and Metro. The list of advisory parties should include: DEQ, Oregon State Health Division, regional wastewater treatment agencies, Army Corps of Engineers, Portland of Portland, and other private large water users. In addition, the involvement of water supply interest groups that have actively participated in the RWSP process should be given an advisory role" (Beaverton).

MATRIX OF PROVIDER RESPONSES TO THE PRELIMINARY REGIONAL WATER SUPPLY PLAN

Location	Beaverlton	Canby	Clackamas	Damascus	Fairview	Forest Grove	Gladstone	Grresham	Hillsboro	Lake Oswego	Metro	Milwaukie	Mt. Scott	Oak Lodge	Portland	Raleigh	Rockwood	Sandy	Sherwood	South Fork	Tigard	Troutdale	Tualatin	Tualatin Valley	West Slope	Wilsonville	Wood Village
Question #1: Which of the key policy values are the most important to you in meeting future water needs?	X	1	1 ¹	1		1	1	1 ¹	1 ¹	1 ¹	X	1	1	1 ¹	3	2	-	1	1		4	1	1 ¹				4
Key Values:	X ⁶		5	4				2	2	2	X	1	2	1 ¹	1	1	-		4		5	1	1				2
System reliability			2	2				1	1	1	X	1	2	1 ¹	1	1	-		1		1	1	1				1
Quality of water sources			3	3				1	2	1	X	1	2	3	1	1	-		3		1	2	2				2
Cost	X		5	1				1	2	2	X	2	2	4	1	1	-		5		2	2	2				2
Environmental Impacts	X		3	3				1	2	1	X	1	2	3	1	1	-		3		1	2	2				1
Diversity of Sources	X		5	1				1	2	2	X	2	2	4	1	1	-		5		5	3	2				6
Efficient Use of Water	X		4	1				1	2	2	X	2	2	5	2	1	-		2		4	2	2				5
Other Values of Importance:	X							1	2	2	X	2	2	6	1	1	-		6		3	2	2				3
Growth Coordination										2	X																
Flexibility													1														
Meets Subregional Needs																											
Question #2: Do you generally support Strategy 1.5?*	Y	Y	Y	N ⁴	- ⁵	Y	Y	Y	Y	Y	N	Y	N	Y	N	N	-	Y	Y	N	Y	Y	Y	Y	Y	Y	Y
Question #4: Do you support a regional water organization?	Y	Y	Y	Y	Y	Y	Y	Y	Y	Y	Y	Y	Y	Y	Y	Y	Y	-	Y	Y	Y	Y	Y	Y	Y	Y	N

define as 100% system reliability.
 onland ranked three tiers of values with raw water quality of source as the highest value
 to priority listed.
 accept lesser level of reliability -- no change otherwise suggested.
 does not take a position at this time.
 defined as finished water quality.
 saw referred to as Strategy 5.

Appendix G
COMMENTS ON THE MARCH 1996 PROPOSED REVISIONS
TO THE
REGIONAL WATER SUPPLY PLAN PRELIMINARY REPORT

**Public Stakeholder Meeting to Discuss Regional Water Supply Plan Revisions
April 19, 1996**

Issues, Interests and Concerns

Invited to this meeting were 39 stakeholder representatives. The invitee list included those state and federal agencies and organizations represented on the Regional Water Supply Plan Environmental Task Force, plus those stakeholder representatives provided testimony on the preliminary plan to at least the Portland and METRO Councils. Stakeholders were invited by mail and follow-up telephone calls. Thirteen individuals (other than project staff) attended the meeting.

Implementation Effectiveness Monitoring

- After all the hard work that's been done we need to ensure that the plan is implemented and kept up to date. What would be the ideal trigger(s) for revisitation of the plan in the future. There should be an annual report outlining what has been accomplished. Revisitation needs to be mandatory and it should be coordinated with review of Metro's Regional Framework Plan.

Source Protection

- The providers are giving different messages in different forums. The Regional Water Supply Plan revisions put more emphasis on water source protection and create a proactive role for the providers in seeking source protection. There doesn't seem to be that level of support in developing Title 3 (Water Quality and Flood Management Conservation) of the Regional Framework Plan (parenthetic added). The participants should be consistent on their commitment to source protection from one forum to another. The Title 3 development process is an excellent opportunity for providers to support source protection.
- There is appreciation that the revised plan allows the water providers to "weigh in" for source protection. Protecting water quality is important for both summer and winter supplies and will need to be dealt with in both urban and rural areas.
- Based on recent experience with flooding in the Bull Run, Clackamas, and Tillamook areas, it is a good thing to keep trees in place both for more water supply during summer and to reduce turbidity during high flow events. To accomplish this will require maintaining the integrity of public land watersheds.
- The plan revisions call for participation in "implementing" the President's Northwest

Forest Plan. The plan actually calls for wide scale logging in the Clackamas Basin and the Bull Run. The plan was developed to maintain species not protect water quality. The Regional Water Supply Plan should focus on improving the forest plan to maintain and improve the source water quality in both winter and summer.

Conservation

- The region may not be ready for conservation ordinances. It might be beneficial for plan implementation to start with education and incentives first, and if they don't work out or more savings is needed, then the providers could impose "more draconian" measures."
- The region needs to do better at dealing with public perception implications of rate increases due to water conservation. There also needs to be assurance that conservation programs will be budgeted.

Water Rights

- There are a number of pending applications for rights to use water from sources in the Portland metro region (e.g., Willamette, Clackamas, Columbia). How do these pending water right applications fit with the findings of the Regional Water Supply Plan. The draft plan does not identify the need for new water rights to meet conservative estimates of future demands in 2050. The Oregon Water Resources Department (OWRD) considers the plan as one of the bases for evaluating some of the water rights. If OWRD doesn't get a clear signal, it will need to ask applicants to show how water rights fit in with the plan.
- The providers have a strong desire to keep options viable. If further development on the Clackamas becomes restricted it will be important to keep the Willamette option open.
- Applicants can ask for deferment of action on the applications until the plan has a chance to be implemented.
- The OWRD is interested in whether the Regional Water Supply Plan can be used to meet all or part of the requirements for conservation/curtailment plans. It would be beneficial if submittal of additional curtailment information (to the OWRD) could be made part of the regional plan.

Water Quality

- The plan, as revised, assigns a high priority ensuring that sources “remain” viable, and to “maintain and enhance” the viability of each of the potential water supply sources. Using the words “remain” and “maintain” here implies that all of the sources are currently viable. Public review of the preliminary plan report showed that many people did not believe the Willamette or Columbia is currently viable as a drinking water source. The suggestion is to eliminate the use of these words and focus on “enhancing” viability.

Wellhead Protection

- Starting to pursue wellhead protection very early will be important for the viability of aquifer storage and recovery(ASR). The revised plan makes a commitment to pursue wellhead protection “at or prior to the pilot test phase of ASR development.” The suggestion is to delete the word “at” from this plan recommendation (Ch. XII, page 22).
- It would be a good idea to work with land use agencies on the fate and management of aggregate mine pits in the Cooper-Bull Mountain area as these pits can intersect the groundwater near one of the ASR representative sites. Backfilling of these pits (e.g., what goes in them) should be done with care.

Public Meeting to Discuss Regional Water Supply Plan Revisions - April 30, 1996

Interests, Issues, and Concerns

This meeting was held on a Tuesday evening at the METRO offices in efforts to facilitate public attendance. The meeting was publicized through direct mail to the Regional Water Supply Plan mailing list of approximately 3,800 and also through a paid advertisement in The Oregonian on the preceding Saturday. Twenty-nine individuals attended the meeting.

General

- Compliments to the water providers for getting this far in the water supply planning process. The issues are tough. It is appropriate to go back and forth in dealing with concerns while revising the plan.
- We are fortunate that our forefathers thought ahead to build our water systems. The long-range planning that's going on now is good.

Public Involvement Process

- Are meetings officially recorded? What is the history of public involvement on this project?
- It is important to get more citizens involved. One suggestion is to hold a public forum on water supply. It might be worth considering a 24-hour public meeting.
- The project needs someone in charge of publicity and public relations. There are a lot of free or low cost opportunities on radio and in newspapers that aren't being utilized. An ad in The Oregonian isn't enough. The regional Hanford advisory boards saved the taxpayers millions of dollars through public involvement and it obtained lots of free radio advertising to announce what's happening.
- We need to get community buy-in for the plan.
- Involving community members won't bias them.

Plan Scope

- What is the time horizon covered by this plan?

- We don't have 20 to 40 years to address the water supply situation. We could have an earlier crisis.
- Why isn't Vancouver, WA included in the study? Vancouver has serious water supply problems.

Conservation/Non-potable Water Options

- We need to do more research into aggressive conservation.
- In 1992 conservation (curtailment) resulted in increased rates which seems counter-productive.
- There should be separate water systems for fresh water and lower quality or reuse water. Graywater needs more evaluation and use.
- Industrial recycling provides a high potential for water savings.
- Dual systems are common in Arizona and Mexico.
- There can be quality and public health problems with dual systems.

Water Sources

- The best quality source is from Bull Run. What does additional diversion from Bull Run mean for other values?
- Portland hasn't gone far enough to look at the Little Sandy River as a source. The Little Sandy deserves protection now and should be procured as a potential source watershed. There should be additional study of storage options on the Little Sandy. The Little Sandy was mentioned only on two pages of the plan as revised and it was lumped with preserving the viability of storage options in the Bull Run Watershed. There is concern that the Little Sandy would only be looked at if the other sources mentioned in the plan don't work out. This could result in PGE getting water rights to the Little Sandy. Citizens interested in the Little Sandy as a source should review a booklet on public involvement and should consider a quote from Arch Diack accusing Portland of giving water rights on the Little Sandy to PGE (The quote was read and the booklet circulated.)

- The Little Sandy is used by one of the last runs of resident trout (e.g., redband) which is rare. Fishery issues are a very important consideration in selecting and developing new sources. "What we do to the earth, we do to ourselves."
- Action should be taken to ensure that Bull Run and the Little Sandy have "their rightful place." The plan should set the stage for ensuring water rights and pursuing permits for dams. Are we going to address this issue? It takes twenty years these days to permit a dam.
- Bull Run Lake should be a last resort because of mitigation costs.
- The recent floods should make it clear that the Willamette River will never be a suitable drinking water source due to upstream point and nonpoint source pollution (including sewage outfalls and CSOs). The City of Salem is still impacted due to turbidity in the Santiam River from the flooding.
- In the future, carbon tetrachloride in the Columbia River will reach levels that are a significant percentage of drinking water standards.
- The Portland wellfield is impacted by chlorinated solvents.
- To use ASR will require strong groundwater protection and limits on industrial development.
- All of the options are problematic for one reason or another. The Willamette is the worst choice. Relying solely on sources near Mt. Hood is dangerous. Hanford poses serious concerns for the Columbia River. The Department of Energy (DOE) has several Environmental Impact Statements out on how to resolve chemical/radioactive waste storage tank issues. An explosion is possible. Some wouldn't be surprised if the chosen resolution is to simply cap and abandon the tanks. DOE findings on cancer risk change depending on who's in charge. The agency can't be trusted to protect the public interest. There are new plutonium leaks migrating toward the river. With these types of issues, looking out 50 years isn't long enough.
- We should look at the water quality and related health problems going on in other countries.

Source Protection

- There is no groundwater protection to speak of at the federal level. It would be worth focusing on establishment of stronger state and federal groundwater protection laws.

We should be looking ahead 100 years.

- We need to call on people for support for source protection and clean water. Clean water is a vital resource for life. We need more education regarding water sources.

Source Reliability

- There seems to be a lack of recognition in the plan that Mt. Hood is still an active volcano. It could erupt into the Bull Run and Little Sandy watersheds. We need a diversity of sources to help get through catastrophic events without major water supply disruption.

Regional Water Provider Consortium

- How will the regional water provider consortium help make sure that the Bull Run is protected?
- What will be the role of the public in consortium decision-making? The consortium has to include public oversight to obtain adequate buy-in.
- There is concern that the consortium won't involve the public and will be dominated by politicians.



CITY of BEAVERTON

4755 S.W. Griffith Drive, P.O. Box 4755, Beaverton, OR 97076 TEL: (503) 526-2481 V/TDD FAX: (503) 526-2571

ROB DRAKE
MAYOR

May 20, 1996

Mr. Michael F. Rosenberger
Chair, Regional Water Supply Plan
Participants Committee

Tim Erwert
Chair, Regional Water Supply Steering
Committee

1120 SW 5th Avenue
Portland, Oregon 97204

Re: ***Revisions to the Regional Water Supply Plan (RWSP)***

Dear Mr. Rosenberger and Mr. Erwert:

Thank you for the opportunity to comment on the proposed revisions to the Regional Water Supply Plan (RWSP). Revision materials were distributed to the Beaverton City Council for review and comment. The City Council is very supportive of the plan and proposed water providers' consortium in general. Comments from the City Council regarding the proposed revisions were limited.

Following are the City's remarks:

- Since 1990, the City of Beaverton has invested heavily in its own in-city water infrastructure to satisfy an existing water storage deficit as well as providing a measure of reserve capacity to accommodate anticipated growth in water demand. The City has a dedicated portion of its water rate to be used toward ongoing replacement of aging water distribution and transmission pipelines, storage reservoirs and other water system facilities. Additionally, the Joint Water Commission (JWC), to which the City has been a member since 1980, has planned, built or has under construction significant improvements to provide water now and for the future. The evaluation of Aquifer Storage and Recovery (ASR) by the JWC, to reduce future peak summertime water demand on the water treatment plant, is in the pilot test stages. Beaverton's financial participation in these projects, following a period of nearly ten years without a water rate increase, have required substantial increases in recent years. With this in mind, the

MAY 25 1996

Council is sensitive to actions by the region's water providers that may effect future water rates for Beaverton.

- The City of Beaverton is supportive of a regional water provider consortium. The consortium concept would provide a vehicle for improved coordination and efficiency of service to all customers in the region while allowing for autonomy of individual water provider agencies to make decisions, such as service levels, jurisdictional boundaries, number of customers, rates, charges, etc. A consortium would also be a way of working together as partners to implement, monitor and update the Regional Water Supply Plan.

The City advocates the prominent role recommended in the revised plan to further explore and implement water conservation, reuse, recycling and substitution of non-potable water for uses that don't require drinking water. Metro has suggested that it coordinate demand side efforts to control and reduce the need for new sources of supply. The City is not opposed to that role. On page 27 of Chapter XII, however, Metro is mentioned as a potential regional water provider. It is stated on that page that Metro has no present desire to become a supplier or distributor of water. The City believes the region's existing water providers have a good record of service and recommend that Metro limit its involvement to the role outlined in the RWSP.

- In the revision to page 20 of Chapter XII of the RWSP, an inter-nodal transmission addition is programmed for the year 2010. It also advises that local transmission additions be programmed with consideration of the potential future supply sources identified in the RWSP. The new transmission system linkages are recommended in order to better utilize existing water supplies and to provide redundancy in the event of catastrophic incidents and maintenance. With the proposed change to a non-specific source increment, planning for the transmission linkages is much more indeterminate. Without a closer idea of future sources, detailed transmission line planning may have to be postponed to avoid misguided sizing and routes.

The preliminary RWSP recommended Strategy 1.5, which favored the Willamette River as the future source increment after 2035. The majority of the RWSP participants supported Strategy 1.5. The revised plan substitutes a non-specific source increment that expands the options to add the Columbia River and Bull Run. From our understanding, the estimated cost of developing additional supply capacity in the Bull Run does not include the cost of constructing and operating a water treatment facility for that source. We feel this is unrealistic in light of the weather events that faced the region this winter and with more stringent drinking water standards expected in future years. The revision to include three source options does increase the decision-making flexibility. However, the certainty needed for planning purposes is postponed and the cost impact of the different options has the potential to dramatically effect water rates dependent on the selected option(s).

Regionally there is a wide degree of variation in water rates. To implement both the near term regional transmission system links and refine the future source(s) of supply, it is important that all regional water providers pursue these decisions with equity in mind. A decision to inter-connect the regional water providers and mutually develop future water sources requires all parties to fairly pay their share as well as agree to use water from whatever source the consortium chooses.

- In Table VIII-2 (page 3 of 4) entitled Local Delivery System Summary, there is a column listing projected 2050 water demand. This figure seems to be under-estimated for Beaverton. For the City of Beaverton, Table VIII-2 indicates a 2050 water demand for peak day high as 17.1 MGD (million gallons per day). Beaverton's actual average day water demand for calendar year 1995 was 7.25 MGD. Using the current peaking factor of 2.5, Beaverton's estimated peak day demand for 1995 was 18.1 MGD, which exceeds the figure shown in Table VIII-2 for the year 2050. Although the region-wide water demand projections in the RWSP are most likely accurate, the estimated 2050 use for Beaverton should be adjusted. The City of Beaverton is in the process of a more detailed projection of future demand for potable water using the latest Metro population estimates.

Sincerely,

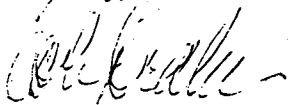

Rob Drake
Mayor



CITY MANAGER'S OFFICE

17 July 1996

Lorna Stickel
Project Manager, Regional Water Supply Plan
Bureau of Water Works
1120 SW 5th Avenue
Portland OR 97204

Re: Response to Proposed Revisions to the Regional Water Supply Plan,
August 1995, Preliminary Report.

Dear Ms. Stickel:

Thank you for the opportunity to review and comment on the proposed revisions to the Regional Water Supply Plan (RWSP) Preliminary Report. Our Council was briefed on the proposed revisions by City staff at their July 2 work session. The Council was pleased to note their earlier comments and suggestions, as outlined in their formal response to the Steering Committee (December 20, 1995), will be incorporated in the final RWSP.

The City Council of Lake Oswego is supportive of the preliminary plan and the proposed revisions. We also reaffirm our commitment to be an active participant in planning for our City's and the region's water supply future. We believe the final plan revisions reflect not only our own particular policy interests but, judging from the responses of others, those of our regional neighbors. As a follow-up to our earlier comments, we submit for the Committee's consideration, the following comments concerning the policy objective regarding growth and land use planning. It is as follows:

- **Growth and Land Use Planning:** - The City Council of Lake Oswego is very concerned with whether or not the region can accommodate the amount and rate of growth being forecast for the planning horizon. We understand that the RWSP will be used to guide the regions water providers in planning for future water supply to serve this growth. However, we suggest that the second policy objective more clearly highlight the relationship between provision of water service and managing growth in ways that are efficient, cost effective and consistent with the maintenance of a compact urban form and liveable communities.

To assure efficient use of existing developed sources and promote the concept of compact communities, it is suggested the implementation action for this policy objective be modified to read:

Work with local governments and Metro to determine the location and extent of future growth and then utilize the plan to provide guidance for the provision of water service

Again, the Council of Lake Oswego wishes to express its appreciation to you Lorna and the rest of your staff and the Participants Committee for all the efforts which have resulted in a water supply planning document the region can be proud of. If you have any questions regarding our comments, please feel free to contact our Utilities Engineer, Joel Komarek.

Very truly yours,



Douglas J. Schmitz
City Manager

DJS/sms

c: Alice L. Schlenker, Mayor
Members of the Lake Oswego City Council
Joel Komarek, Utilities Engineer



METRO

July 11, 1996

Mr. Michael F. Rosenberger
Chair, Regional Water Supply Plan
Participants Committee
1120 SW 5th Avenue
Portland, Oregon 97204

Mr. Tim Erwert
Chair, Regional Water Supply Steering
Committee

Re: Comments on Revisions to the Regional Water Supply Plan (RWSP)

Dear Mr. Rosenberger and Mr. Erwert:

Thank you for the opportunity to comment on the proposed revisions to the Regional Water Supply Plan (RWSP). The Metro Council's Growth Management Committee and the Metro Council have reviewed the proposed revisions with regard to how they incorporate the Metro Council's comments and recommendations on the draft *Regional Water Supply Plan*. The Metro Council commends you and the project's staff for the excellent job you have done in incorporating the diverse comments from the study's participants and the public into the proposed revisions.

The Metro Council is still very supportive of the plan and it will be the basis for the water supply and storage element of the Metro *Regional Framework Plan*. The Metro Council also supports formation of the consortium to implement the plan and Metro plans to be an active participant in implementing the plan. I am forwarding the following comments from the Metro Council on the proposed revision.

1. In Figure XII-___ entitled "Recommended Resource Strategy Regional Water Supply Plan", the Council recommends that on the timeline before "Source Increment" there be a circle added that is entitled "Pilot Studies" to reflect the fact that pilot studies have to be carried out before any new source increment is brought on line.
2. The Council still recommends that the feasibility and funding options for an instream flow incremental methodology (IFIM) on the Clackamas River be pursued with sub-regional partners.
3. The Council strongly supports the functions that have been identified for a consortium that would implement the RWSP. The Council needs to know, however, how the consortium is proposed to be funded and what resources Metro will be asked to contribute to this effort. The Council requests that it have the opportunity to review any draft information related to the

JUL 15 1996

formation and funding of the consortium.

4. Finally, the Council recognizes the importance of involving the public in all aspects of implementing the water supply plan, particularly with regard to water conservation programs. The Council recommends that the consortium identify ways to directly involve the public in a cost effective and efficient manner to ensure the success of the conservation programs. Options for involving the public could include the following: formation of a citizen advisory committee, public involvement activities by agencies participating in the consortium, different educational programs to educate and involve the public (one example that Metro is interested in pursuing is establishment of a water conservation "hotline" which could become a clearinghouse for information on water conservation), and attendance of citizens at the different consortium committee meetings.

The Council recognizes that public involvement is anticipated to play an important role in the proposed Regional Water Consortium. The draft Intergovernmental Agreement (IGA) that would form the consortium identifies several specific ways to involve the public. These strategies and others suggested above need to be a high priority of the consortium.

Thank you again for the opportunity to comment on the proposed revisions to the Regional Water Supply Plan. Please contact me if you have any questions regarding these comments and the Metro Council looks forward to the adoption of the plan.

Sincerely,

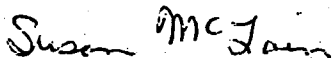

Councilor Susan McLain, Chair
Growth Management Committee
Water Resources Policy Advisory Committee

cc: Mike Burton, Executive Officer
John Fregonese, Growth Management Services
Rosemary Furfey, Growth Management Services



CITY OF
PORTLAND, OREGON

OFFICE OF PUBLIC UTILITIES

Mike Lindberg, Commissioner
1220 S.W. Fifth Ave.
Portland, Oregon 97204
(503) 823-4145

MEMORANDUM

TO: Michael Rosenberger, Water Bureau Administrator
and Chair, Regional Water Supply Plan Participants Committee

FROM: Commissioner Mike Lindberg *Mike*

DATE: July 31, 1996

SUBJECT: Comments on Proposed Revisions to the Regional Water Supply Plan

I have reviewed the proposed revisions to the draft *Regional Water Supply Plan* with regard to how they incorporate the Portland City Council's comments on the preliminary plan-report (dated August 1995). From my perspective, the revisions address the key issues raised by the City Council in its written response to the preliminary draft. I also understand that each of the other Commissioners or their staff have been briefed on the proposed revisions and have not requested additional changes.

Given these revisions I will be comfortable endorsing the plan when it is submitted with an Intergovernmental Agreement to form a Regional Water Provider Consortium. However, the Portland's Water Quality Advisory Committee has asked that a few additional refinements be incorporated into the final plan. I believe that the Committee's recommendations are consistent with the direction of the plan overall, and would provide beneficial clarification and emphasis. Thus, I request that the project staff and Steering Committee consider incorporating the attached suggestions into the final plan.

Finally, I would like to express my appreciation to the project staff, Steering Committee and all the participating agencies for showing such responsiveness in addressing comments on the preliminary *Regional Water Supply Plan*. Thank you all for your continued hard work to develop a plan that the whole region can support.

cc: Mayor Vera Katz
Commissioner Charlie Hales
Commissioner Gretchen Kafoury
Jeff Golden
Regional Water Supply Plan Steering Committee
Lorna Stickel

Suggested Refinements for Incorporation in the Final Regional Water Supply Plan

- State in Chapters IV and XII that the policy objectives presented in tables and text are not ranked or presented in priority order.
- Recognize the potential for water use efficiency opportunities to increase over time by changing the policy objective in Table XII-1 under “Efficient Use of Water” to: **“Maximize the efficient use of water resources, taking into account current and potential conservation opportunities....”** (changes in bold)
- Acknowledge the relationship between conservation and environmental stewardship by changing the second policy objective under the Environmental Stewardship section of Table XII-1 to: **“Foster protection of environmental values through water source protection and enhancement efforts, and conservation.”** (changes in bold)
- Highlight the diversity of approaches that can be taken to manage water shortages. Please augment the first policy objective in Table XII-1 under “Water Supply Shortages” to read: **“Minimize the frequency, magnitude, and duration of water shortages through a variety of methods including development and operation of efficient water supply systems, watershed protection, and water conservation.”**
- Add a policy objectives under “Land Use and Growth Management” that says: **“Promote decision-making in consideration of interrelationships between land use, growth, community livability and water resource sustainability.”**
- Include **public health considerations** to the list of assessment items in Generic Resource Strategy graphic Figure XII-1.
- Make clear that more data is needed to understand the potential opportunities and impacts associated with ASR. Please add a sentence to the second paragraph on page 21 of Ch. XII stating: **“However, additional information will be generated to assess the potential costs and impacts (including effects on peak streamflows) of ASR through required permitting and pilot procedures.”** (This is consistent with the first implementation action bullet below on the same page.)
- Make sure that the implementation actions for each of the source options include the following points (or something similar):
 - **“Seek protection of the source and associated watershed(s). Participate as appropriate in relevant administrative and legislative efforts to manage riparian areas and uplands, forest and agricultural practices, industrial discharges and stormwater.”**
 - **“Coordinate with land use planning and growth management efforts to maintain and enhance source viability.”**
- Specific to Willamette River, specify that monitoring should include assessment of how high and low flow levels correspond to differences in water quality.



SOUTH FORK WATER BOARD

COMBINED WATER OPERATIONS OF OREGON CITY AND WEST LINN, OREGON

PO BOX 351
OREGON CITY, OR 97045
BUSINESS OFFICE (503) 657-0891
FILTER PLANT (503) 657-5030

July 24, 1996

Lorna Stickel
Regional Water Supply Plan Project
1120 SW 5th, #601
Portland, OR 97204-1926

SUBJECT: ACCEPTANCE OF REGIONAL WATER SUPPLY PLAN

Lorna:

The South Fork Water Board hereby accepts the Regional Water Supply Plan(RWSP). The work and efforts of all the participants is truly a monumental task and reflects the cooperative spirit amongst the regions drinking water providers.

The South Fork Water Board also looks forward to the formation of the Regional Water Providers Consortium and being an active participant when the Intergovernmental Agreement is ratified.

Sincerely,

Dan Bradley
General Manager

cc: Dan Fowler, SFWB Chair
Jill Thorn, SFWB Vice-Chair



CITY OF
PORTLAND, OREGON
WATER QUALITY ADVISORY COMMITTEE

Mike Lindberg, Commissioner
Kathleen A. Concannon, Chair
1120 S.W. 5th Avenue
Portland, Oregon 97204-1928
Information: (503) 823-7404
FAX: (503) 823-6133
TDD: (503) 823-8868

Date: May 1, 1996

To: Commissioner Mike Lindberg

Fr: Jerry Moss, Vice Chair
Water Quality Advisory Committee

Re: Regional Water Supply Plan Draft Report

The Water Quality Advisory Committee (WQAC) appreciates the time and effort expended by Water Bureau staff in providing information to the committee during the Regional Water Supply Planning process. We especially appreciate the Plan's incorporation of many of our recommendations, including the following: 1) focusing on conservation as an integral part of the Plan's policy objectives and implementation strategy; 2) recognizing that the city of Portland and several others reject the Willamette River as an acceptable water source; 3) considering the Little Sandy River as a potential future water source; 4) including watershed protection as a key element of any future strategy; 5) pursuing the use of dual systems; and, in general, 6) the fact that the Plan more closely coincides with public values.

WQAC has reviewed the Draft Regional Water Supply Plan. We have several additional recommendations that reflect our continuing focus on water quality and concern for public values:

1. In our 10/13/95 letter to Commissioner Lindberg, we recommended that the final Plan give more weight to raw water quality than other values. We understand that several concerns led staff to rank the Policy Objectives listed in Table XII-1 equally. Given the possible public perception that the Objectives are, in fact, ranked in order of priority, we recommend that Table XII-1 contain language specifying that there is no ranked order to the Policy Objectives.
2. The Committee recognizes that opportunities for improvements in water use efficiency may increase over time with the availability of new technologies and changes in public values. As a result, we recommend that the first sentence in Table XII-1 under "Efficient Use of Water" read as follows:
 - Maximize the efficient use of water resources, taking into account **current and potential** conservation opportunities, availability of supplies, practicality, and relative cost-effectiveness of the options. (changes in bold)

May 1, 1996
Water Quality Advisory Committee
Page 2

3. The Committee is concerned that the Plan's commitment to "maximize operational flexibility" and "ability to move water around the region" not compromise the region's conservation efforts. The Committee recommends that the Bureau and Plan Participants work to assure that any future improvements or changes to the water transmission "grid" incorporate conservation goals and workable incentives.

4. The Committee believes strongly that conservation represents a vital part of the region's commitment to Environmental Stewardship. As a result, we recommend that the second bullet under the Environmental Stewardship section of Table XII-1 read as follows:

- Foster protection of environmental values through water source protection and enhancement efforts, as well as conservation. (changes in bold)

5. Data from a study entitled *Peak Flow Responses to Clearcutting and Roads in Small and Large Basins, Western Cascades, Oregon*, written by J.A. Jones and G.E. Grant at Oregon State University and the Pacific Northwest Research Station of the U.S. Forest Service, shows that clearcutting can cause significant increases in peak flows in both large and small basins in westside Cascade forests. The Committee believes that such peak flows are associated with both high turbidity levels and water shortages during low-flow periods. Another study by Hicks (1991) indicates significant decreases of 25% and 14 % respectively in July and August streamflows as a result of clearcut logging in the Bull Run Watershed. The Committee believes that water providers need to consider the potential impact of land management practices such as logging on water supply. As a result, the Committee recommends that the first bullet of the section on Water Supply Shortages in Table XII-1 read as follows:

- Minimize the frequency, magnitude, and duration of water shortages through a variety of methods, including watershed protection at the source and water conservation at the tap. (changes in bold)

6. Public health considerations should play a central role in the Plan. As a result, the Committee recommends that Public Health be included as an assessment item under the Generic Resource Strategy under Figure XII-1, page 11.

The Committee also recommends adding water quality and environmental stewardship to protect water quality and quantity as assessment items to be included under the same heading.

7. The committee believes that existing data on the environmental impact and cost of Aquifer Storage and Recovery (ASR) is inadequate. We do not fully understand the impacts and costs in part because the source, the amount of water used for the program, and the receiving aquifers have yet to be identified. To state that environmental impacts are expected to be relatively low minimizes the potential impact on aquatic life and those endangered species that rely on high

May 1, 1996
Water Quality Advisory Committee
Page 3

flow during winter months.

8. The Committee recommends the following language be added to Chapter XII, page 22, to help protect water quality in the Clackamas River basin and preserve the Clackamas River option:

- Maintain the 3-Basin Rule, which prohibits industrial discharges into the Clackamas River.
- Advocate protection of the watershed-based sources of the Clackamas River, including administrative and/or legislative efforts to restrict logging on public land in the Clackamas River Basin which could decrease both water quality and quantity. Given the fragile state of the post-flood watershed, planned logging levels are too high and bring unacceptable risks of high turbidity levels during fall and winter peak flows.
- Study the impact of using agricultural chemicals and initiate appropriate actions to restrict their application on public land in the basin.
- Coordinate with local and regional land use planning efforts to assist in maintaining source viability through various means, including creation of stream buffers and modification of urban reserve boundaries when necessary.

9. The Committee recommends that the following language be added to Chapter XII, page 23, to protect water quality in the Willamette River Basin:

- Conduct further pilot testing and water quality monitoring and analysis, with an emphasis on high and low flow status.
- Work to maintain the 3 Basin Rule.

10. The Committee recommends that the following language be added to Chapter XII, page 24, to protect water quality in the Bull Run Watershed:

- Support legislation protecting the Bull Run/Little Sandy from additional logging on federal land and/or improve the President's Forest Plan to prohibit logging on these lands.

11. In the process of developing and assessing information for decisions made as part of the regional water supply plan, the Committee supports an approach based on sustainable development for the region. Such development must not degrade raw water quality.

Once again, we appreciate the chance to review the Regional Water Supply Plan and to recommend changes. We request that you consider them fully. We would be happy to meet with you to answer any questions that arise about our recommendations.

Jerry C. Moss, Vice Chair
Water Quality Advisory Committee

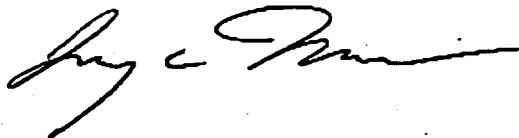



United States
Department of
Agriculture

Forest
Service

Mt. Hood National Forest

2955 NW Division St.
Gresham, OR 97030
(503) 666-0700
FAX # (503) 666-0641

File Code: 2520

Date: 06/24/96

Lorna Suickel
City of Portland, Water Bureau
1120 SW 5th, 6th Floor
Portland, OR 97204

Dear Lorna:

I want to sincerely thank you, Roberta, and Dale for stopping by the office on April 8th. I think the direct communication is valuable as we search for ways to support each other and work together.

I was encouraged to see the revised Regional Water Supply Plan you sent over. It is evident that your team has given much thought to balancing environmental impacts with supplying sufficient potable water to the Metro area. The increased emphasis on water conservation is also very encouraging; we support both voluntary and required conservation methods.

There are three main areas that cause the Forest concern--

First, the revised Preliminary Study identifies the Clackamas River as the next major source to tap for additional water, with plans to draw approximately 140MGD out of the river. Increased withdrawals could have detrimental effects on recreationists and on the fisheries we have worked so hard to maintain and restore upstream. While we understand that permits would be necessary for some of the additional withdrawals, the total amount withdrawn and the the location of the withdrawals could have serious environmental and social implications. Our experience in the Bull Run-- the current total dewatering of the Bull Run River, which comprises 26% of the entire Sandy River System-- is a reminder of where this could ultimately lead without a commitment from the water providers and users to not propose those kinds of actions.

Second, our discussion of source water protection and the City's current posture of total exclusion of the public from the Bull Run River drainage as necessary for protection causes me great concern. It is my belief, that if the Clackamas becomes a primary source for Metro water supplies, current use of the Clackamas system for recreation and other uses could be challenged. If history is any indicator, without any scientific reasons, the water providers could be pressured to curtail or eliminate many of these uses. There will be costs and benefits from eliminating the public or other uses and we recommend they both be disclosed.

We realize that the Water Bureau does not intend to either dewater the Clackamas or keep the public out, but based on our experiences with the Bull Run and user groups who have had goals very different from those established in PL 95-200, we feel our concerns are real, and not "crying wolf."



Caring for the Land and Serving People





Third, the report does not discuss the opportunities the Metro area has to more fully utilize the existing reservoir storage by the addition of filtration to the Bull Run system. You mentioned the cost of doing this and the belief that this would add 34MGD/day to the supply. The additional 3.5-4.0 billion gallons available with filtration would increase the water available from storage by 35-40%, a substantial additional supply. If the costs of my first and second concerns are fully recognized, I believe the relative cost of filtration in the Bull Run System looks much more attractive.

We also appreciate the Bureau's concerns about the current system's vulnerability to fires, earth quakes, volcanoes, etc.

We agree that the Willamette River should be left "on the table" as a possible future source. If cleaned up, it could offer the best alternative source at the lowest cost and least environmental impact. I think if science and economics are considered along with a commitment to clean up the Willamette, it should remain high on the priority list.

Let me conclude by stating that the Mt. Hood staff stands ready to assist you in your effort to complete this plan. I think the consortium of water providers is an excellent idea. We can also help you reach out to a wide public audience, which is one of the stated objectives of the plan. I suggest we bring the plan to the attention of organizations like the Confederated Tribes of Warm Springs, the Northwest Forestry Association, and several local recreation groups we work with, in addition to the organizations you have already involved-- the Pacific Rivers Council, The Northwest Steelheaders, Oregon Trout, Oregon Dept. of Fish and Wildlife. You might also ask the Willamette Province Advisory Committee if they would like to see the Plan before it is finalized.

Sincerely,

Roberta A. Moltzen

ROBERTA A. MOLTZEN
Forest Supervisor

